

UNI-T®

**UT531
UT532
UT533
Users Manual**

**Insulation
Resistance
Multimeters**



P/N:110401103678X
DATE:2018.06.26
REV.4

Table of Contents

Title	Page
Introduction	5
Safety Information	5
Unpacking Inspection	9
The Meter Structure	10
Rotary Switch Positions	11
Buttons	13
Understanding the Display	17
Making Basic Measurements	20
Measuring AC Voltage	20
Measuring DC Voltage	23
Measuring DC Millivolts	25
Measuring Resistance and Capacitance	27
● Measuring Resistance	27
● Measuring Capacitance	29
Testing for Continuity	31
Testing Diodes	33
Measuring AC or DC Current	35
Measuring Frequency	38
Measuring Temperature	40
Testing Insulation	42

Title	Page
Cleaning	45
Replacing the Batteries	46
Replacing the Fuse	48
Specifications	49
Electrical Specifications	50
AC Voltage Measurement	50
DC Voltage Measurement	51
DC Millivolts Measurement	51
AC Current Measurement	51
DC Current Measurement	52
Ohms Measurement	52
Capacitance	52
Diode Test	53
Continuity Test	53
Temperature Measurement	53
Frequency Measurement	54
● At mV $\overline{\text{---}}$ Range	54
● At DCV/ACV Range	55
Insulation Specifications	55
● UT531	55
● UT532	56
● UT533	57

List of Tables

Table	Title	Page
1.	Symbols	8
2.	Unpacking Inspection	9
3.	Rotary Switch Selections	12
4.	Buttons	14
5.	Display Indicators	18
6.	General Specifications	49

List of Figures

Figure	Title	Page
1.	The Meter Structure -----	10
2.	Rotary Switch -----	11
3.	Buttons -----	13
4.	Display Indicators -----	17
5.	Measuring AC Voltage -----	20
6.	Measuring DC Voltage -----	23
7.	Measuring DC Millivolts -----	25
8.	Measuring Resistance -----	27
9.	Measuring Capacitance -----	29
10.	Testing for Continuity -----	31
11.	Testing Diodes -----	33
12.	Measuring AC or DC Current -----	35
13.	Measuring Frequency -----	38
14.	Measuring Temperature -----	40
15.	Testing Insulation -----	42
16.	Replacing the Fuse and Battery -----	46

Introduction

The UNI-T Models UT531, UT532 and UT533 are battery-powered, true RMS insulation multimeters (hereafter “the Meter”) with 6000 count display.

The Meter measures or tests the following:

- AC/DC voltage and current
- Resistance
- Voltage and current frequency
- Diode
- Continuity
- Capacitance
- Temperature (Model 532 and UT533 only)
- Insulation Testing

Safety Information

These Meters meet CAT III 1000V and CAT IV 600V IEC61010 standards: in pollution degree 2 and double injection.

CAT III: Distribution level, fixed installation, with smaller transient overvoltages than CAT IV.

CAT IV: Primary supply level, overhead lines, cable systems etc.

Use the Meter only as specified in this users manual. Otherwise protection provided by the Meter may be impaired. See Table 1 for a list of symbols used on the Meter and in this manual.

A  **Warning** identifies hazardous conditions and actions that could cause bodily harm or death.

A  **Caution** identifies conditions and actions that could damage the Meter, the equipment under test, or cause permanent loss of data.

Warning









To avoid possible electric shock or personal injury, follow these guidelines:

- **Use the Meter only as specified in this manual or the protection provided by the Meter might be impaired.**
- **Do not use the Meter or test leads if they appear damaged, or if the Meter is not operating properly. If in doubt, have the Meter serviced.**
- **Always use the proper terminal, switch position, and range for measurements before connecting Meter to circuit under test.**

- **Verify the Meter's operation by measuring a known voltage.**
- **Do not apply more than the rated voltage as marked on the Meter, between the terminals or between any terminal and earth ground.**
- **Use caution with voltages above 33V ac rms, 46.7V ac Peak, or 70V dc. These voltages pose a shock hazard.**
- **Replace the battery as soon as the low battery indicator () appears.**
- **Disconnect circuit power and discharge all high-voltage capacitors before testing resistance, continuity, diodes, or capacitance.**
- **Do not use the Meter around explosive gas or vapor.**
- **When using the test leads, keep your fingers behind the finger guards.**
- **In order to comply with the safety standard, the Meter must be used along with the included test leads. Any damages of the test lead, must replace it with the same model number and specification.**
- **Remove test leads from the Meter before opening the Meter case or battery door. Never operate the Meter with the cover removed or the battery door open.**
- **Comply with local and national safety requirements when working in hazardous locations.**
- **Under the influence of Radio-Frequency Electromagnetic Field & Conducted Radio-Frequency Electromagnetic Field phenomenon. The captioned model have a magnificent error in function measurement. It will be back to normal when the interference is removed.**

- Use proper protective equipment, as required by local or national authorities when working in hazardous areas.
- Avoid working alone.
- User only the replacement fuse specified or the protection may be impaired.
- Check the test leads for continuity before use. Do not use if the readings are high or noisy.
- Do not use current terminals or current range to test voltage.

Table 1. Symbols

	Double Insulated		Earth Ground
	AC (Alternating Current)		DC (Direct Current)
	Diode		Battery (Low battery when shown on display)
	Continuity Buzzer		AC or DC (Alternating Current or Direct Current)
	Conforms to Standard of European Union		

Unpacking Inspection

Open the package case and take out the Meter. Check the following items carefully to see any missing or damaged part:

Table 2. Unpacking Inspection

Users Manual	1 piece
Test Lead	1 pair
Short Lead	1 pair
Alligator Clip	1 pair
K type thermocouple (UT532 and UT533 only)	1 piece
Batteries AA (AM3/LR6)	6 pieces

In the event you find any missing or damage, please contact your dealer immediately.

The Meter Structure

1. Front Housing
2. LCD Display
3. Functional Buttons
4. Rotary Switch
5. Input Terminals

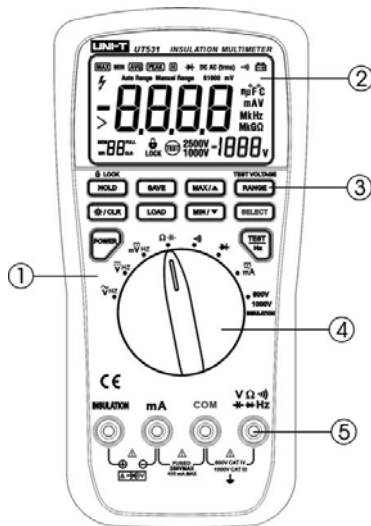

Figure 1. The Meter Structure

Table 3. Rotary Switch Selections

Switch Position	Measurement Function
$V \sim$	AC voltage from 60mV to 1000V.
$V \text{---}$	DC voltage 1mV to 1000V.
$mV \text{---}$	DC mV 0.01mv to 600mV
(UT532 and UT533 only)	Temperature from -40°C to +537°C (-40°F to +998°F). Celsius is the default temperature measurement unit.
$\Omega \text{---}$	Ohms from 0.1 to 40M. Capacitance from 0.01nF to 100µF.
$\rightarrow \text{))}$	Continuity test. Beeper turns on at <30
$\rightarrow \text{+}$	Diode test. There is no ranging in this function.
$mA \sim$	DC mA from 0.01mA to 600mA (600mA overload for 2 minutes maximum) AC mA from 3mA to 600mA (600mA overload for 2 minutes maximum).
insulation	Press to perform insulation test UT531: From 0.5M to 600M. Select 500V and 1000V testing voltage. UT532: From 0.2M to 2G. Select 250V, 500V and 1000V testing voltage. UT533: From 0.1M to 2G. Select 50V, 100V, 250V, 500V and 1000V testing voltage.

Buttons

Use the buttons to activate features that augment the function selected with the rotary switch. The buttons are shown in Figure 3 described in Table 4.

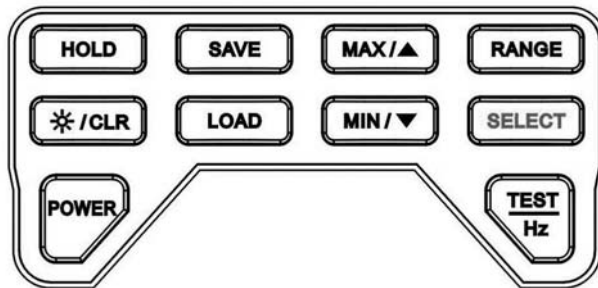

Figure 3. Buttons

Table 4. Buttons

Button	Description
POWER	Press POWER to turn on the Meter. Press and hold POWER to turn off the Meter
HOLD	In insulation Test mode, this schedules a test lock the next time you press TEST on the Meter. The test lock acts to hold down the button until you press HOLD or TEST again to release the lock. In order measurement mode: Press to freeze the displayed value. Press again to release the display.
*/CLR	Press and hold the button to clear the stored data. Press the button to turn the backlight on and off.
SAVE	Press this button to store the single record. Press and hold this button to store data continuously. Press SAVE again to exit continuous data storing mode. The maximum number of data store is 99 sets. The Meter displays FULL when it reaches the maximum. Press CLR to clear the stored data in order to store next set of data

Table 4. Buttons

Button	Description
LOAD	<ul style="list-style-type: none"> ● Press this button once to recall the stored value. Press or to recall the previous or next stored value. Press LOAD again to exit data recall mode. ● Press and hold this button to recall the stored data continuously. Press LOAD again to exit. ● After entering the Load mode, it is not allowed to turn the rotary switch to enter to measuring mode. You can only enter the measuring mode after exiting the Load mode.
MAX / ▲	<p>In Measurement mode, except buzzer, diode and insulation test, press to start retaining maximum value.</p> <p>In Load, each press to go back to the previous stored reading</p>
MIN / ▼	<p>In Measurement mode, except buzzer, diode and insulation test, press to start retaining minimum value.</p> <p>In Load, each press to recall the next stored reading.</p>
RANGE	<p>In Insulation Test mode, press to select different testing voltage.</p> <p>In other mode, except buzzer and diode, press to change Ranging</p>

Table 4. Buttons

Button	Description
RANGE	mode from Auto to Manual Ranging mode. Press and hold to return to Auto Ranging mode.
SELECT	Functions as a shift key. Press to access orange functions on the rotary switch.
<u>TEST</u> Hz	Initiates an insulation test when the rotary switch is on the INSULTION position. Causes the Meter to source (output) a high voltage and measure insulation resistance.
	InMeasurement mode, activate frequency measurement.

Understanding the Display

Display indicators are shown in Figure 4 and described in Table 5.

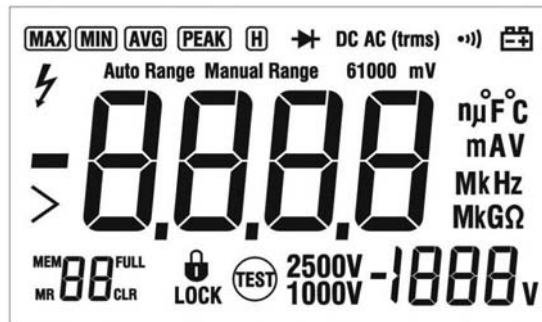

Figure 4. Display Indicators

Table 5. Display Indicators







Indicator	Description
MAX	Indicates maximum reading has been selected.
MIN	Indicates minimum reading has been selected.
H	Indicates display hold is active
	Diode test function is selected
DC AC	AC / DC Voltage or Current measurement
trms	True RMS measurement
	Continuity test function is selected
	Low battery. Indicates when it is time to replace the battery. ⚠ Warning To avoid false readings, which could lead to possible electric shock or personal injury, replace the battery as soon as the low battery indicator appears
	High voltage warning
Auto Range	Auto ranging mode
Manual Range	Manual ranging mode

Table 5. Display Indicators

Indicator	Description
61000mV	Display range in use
—	Negative symbol
>	Greater than symbol
8888	Primary display
MEM	Data store symbol
MR	Data recall symbol
88	The number of stored data
FULL	When the number of stored data reaches 99, the display will show FULL. When the number of stored data is full, press CLR to clear up the stored data before storing another set of data
CLR	Clear up the stored data
 	Indicates a test lock will be applied the next time you press TEST on the Meter. The test lock acts to hold down the button until you press HOLD or TEST again.
2500V 1000V	Source voltage rating for insulation test. UT531: 500V and 1000V ranges available. UT532: 250V, 500V and 1000V ranges available. UT533: 50V, 100V, 250V, 500V and 1000V ranges available.
1888	Secondary Display
	Measurement units

Making Basic Measurements

Measuring AC Voltage (see figure 5)

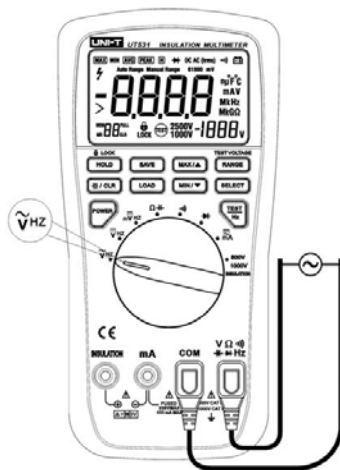

Figure 5. Measuring AC Voltage

 **Warning**

To avoid harm to you or damages to the Meter from electric shock, please do not attempt to measure voltages higher than 1000V although readings may be obtained.

The AC Voltage ranges are: 6.000V, 60.00V, 600.0V and 1000V. If over the range, it displays "OL". To measure AC voltage, connect the Meter as follows:

1. Insert the red test lead into the **V Ω \overleftarrow{f} \rightarrow Hz** terminal and the black test lead into the **COM** terminal.
2. Set the rotary switch to **V \sim** .
3. Connect the test leads across with the object being measured.
The measured value shows on the display.
4. The displayed value is True RMS.

Note:

- If the value of voltage to be measured is unknown, set the Meter to autoranging or use the maximum measurement position 1000V and reduce the range step by step until a satisfactory reading is obtained.
- In each range, the Meter has an input impedance of $10M\Omega$. This loading effect can cause measurement errors in high impedance circuits. If the circuit impedance is less than or equal to $10k\Omega$, the error is negligible (0.1% or less).
- When DC voltage measurement has been completed, disconnect the connection between the testing leads and the circuit under test, and remove the testing leads away from the input terminals of the Meter.

UT531/UT532/UT533 : USERS MANUAL

Measuring DC Voltage (see figure 6)

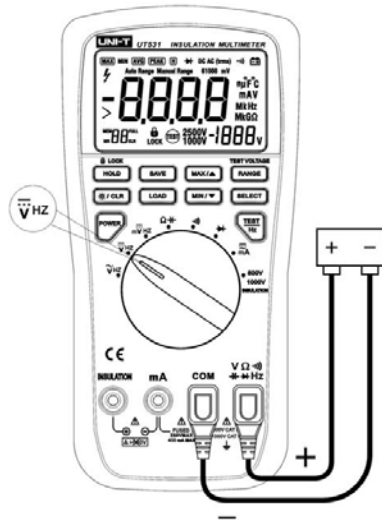

Figure 6.Measuring DC Voltage

Warning

To avoid harm to you or damages to the Meter from electric shock, please do not attempt to measure voltages higher than 1000V although readings may be obtained.

The DC Voltage ranges are: 6.000V, 60.00V, 600.0V and 1000V. If over the range, it displays "OL". To measure DC voltage, connect the Meter as follows:

1. Insert the red test lead into the **V Ω Hz** terminal and the black test lead into the **COM** terminal.
2. Set the rotary switch to **V $\overline{\text{---}}$** .
3. Connect the test leads across with the object being measured. The measured value shows on the display.

Note:

- If the value of voltage to be measured is unknown, set the Meter to autoranging or use the maximum measurement position 1000V and reduce the range step by step until a satisfactory reading is obtained.
- In each range, the Meter has an input impedance of 10M Ω . This loading effect can cause measurement errors in high impedance circuits. If the circuit impedance is less than or equal to 10k Ω , the error is negligible (0.1% or less).
- When DC voltage measurement has been completed, disconnect the connection between the testing leads and the circuit under test, and remove the testing leads away from the input terminals of the Meter.

Measuring DC Millivolts (see figure 7)

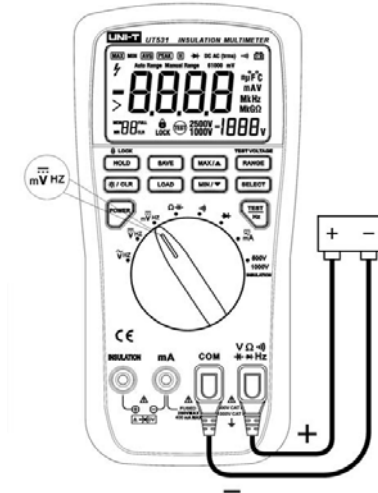

Figure 7.Measuring DC Millivolts



Warning

To avoid harm to you or damages to the Meter from electric shock, please do not attempt to measure voltages higher than 500V, otherwise you cannot obtain correct reading.

The DC Millivolts ranges are: 60.000mV and 600.0mV. If over the range, it displays "OL". To measure DC Millivolts, connect the Meter as follows:

1. Insert the red test lead into the **VΩ Hz** terminal and the black test lead into the **COM** terminal.
2. Set the rotary switch to **mV**.
3. Connect the test leads across with the object being measured.
The measured value shows on the display.

Note:

- The maximum input impedance is 4000MΩ.
- When DC Millivolts measurement has been completed, disconnect the connection between the testing leads and the circuit under test, and remove the testing leads

Measuring Resistance and Capacitance

- **Measuring Resistance** (see figure 8)

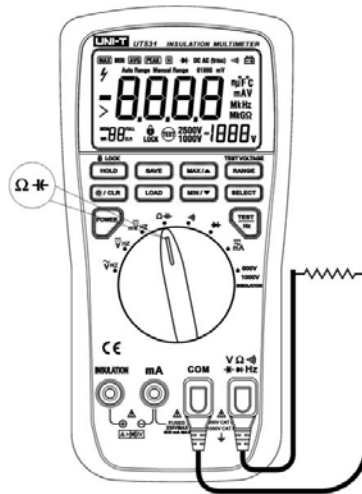

Figure 8.Measuring Resistance



Warning

To avoid electric shock, injury, or damage to the Meter, disconnect circuit power and discharge all high-voltage capacitors before testing resistance.

The Resistance ranges are 600.0 Ω , 6.000k Ω , 60.00k Ω , 600.0k Ω , 6.000M Ω and 40.00M Ω

To measure resistance, connect the Meter as follows:

1. Insert the red test lead into the **V Ω Hz** terminal and the black test lead into the **COM** terminal.
2. Set the rotary switch to **Ω** . Resistance measurement is default or press **SELECT** button to select Ω measurement mode.
3. Connect the test leads across with the object being measured.
The measured value shows on the display.

Note:

- When Resistance measurement has been completed, disconnect the connection between the testing leads and the circuit under test, and remove the testing leads away from the input terminals of the Meter.

- **Measuring Capacitance** (see figure 9)

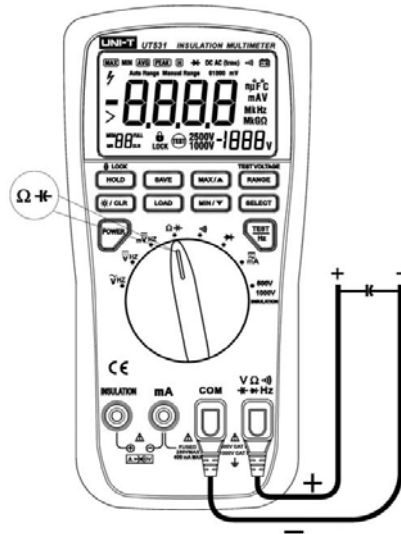

Figure 9. Measuring Capacitance

Warning

To avoid electric shock, injury, or damage to the Meter, disconnect circuit power and discharge all high-voltage capacitors before testing capacitance. Use the DC Voltage function to confirm that the capacitor is discharged.

The Capacitance ranges are 10.00nF, 100.0nF, 1000nF, 10.00 μ F and 100.0 μ F

To measure capacitance, connect the Meter as follows:

1. Insert the red test lead or red short lead with alligator clip into the **V Ω Hz** terminal and the black test lead or black short lead with alligator clip into the **COM** terminal. If the capacitor being tested has polarity, connect the positive into the **V Ω Hz** terminal and the negative into the **COM** terminal
2. Set the rotary switch to **Ω Hz**. Press **SELECT** button to select capacitance measurement mode
3. Connect the test leads across with the object being measured.
The measured value shows on the display.

Note:

- When Capacitance measurement has been completed, disconnect the connection between the testing leads and the circuit under test, and remove the testing leads away from the input terminals of the Meter.

Testing for Continuity (see figure 10)

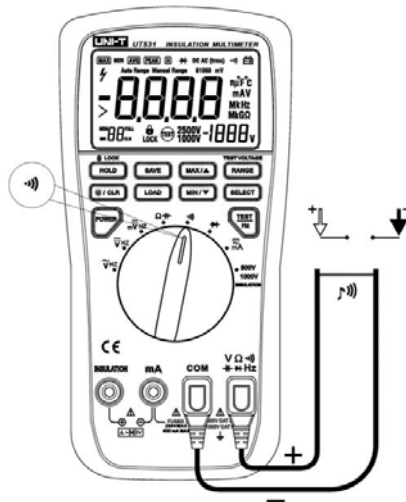

Figure 10. Testing for Continuity



Warning

To avoid electric shock, injury, or damage to the Meter, disconnect circuit power and discharge all high-voltage capacitors before testing continuity.

To measure capacitance, connect the Meter as follows:

1. Insert the red test lead into the **VΩH \leftrightarrow Hz** terminal and the black test lead into the **COM** terminal.
2. Set the rotary switch to .
3. Continuous audible tone for test resistance below 30 Ω

Note:

- When Continuity measurement has been completed, disconnect the connection between the testing leads and the circuit under test, and remove the testing leads away from the input terminals of the Meter.

Testing Diodes (see figure 11)

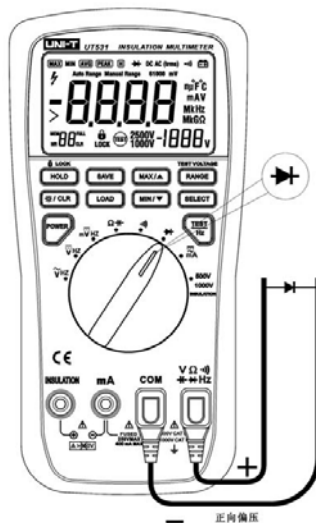

Figure 11. Testing Diodes

Warning

To avoid electric shock, injury, or damage to the Meter, disconnect circuit power and discharge all high-voltage capacitors before testing diodes.

To measure diode, connect the Meter as follows:

1. Insert the red test lead into the **VΩHfHz** terminal and the black test lead into the **COM** terminal.
2. Set the rotary switch to **→**.
3. For forward voltage drop readings on any semiconductor component, place the red test lead on the component's anode and place the black test lead on the component's cathode.

The measured value shows on the display.

Note:

- In a circuit, a good diode should still produce a forward voltage drop reading of 0.5V to 0.8V; however, the reverse-voltage drop reading can vary depending on the resistance of other pathways between the probe tips.
- Connect the test leads to the proper terminal as said above to avoid error display. The LCD will display OL indicating diode being tested is open or polarity is reversed.
- The unit of diode is Volt (V), displaying the forward voltage drop readings.
- When Diode measurement has been completed, disconnect the connection between the testing leads and the circuit under test, and remove the testing leads away from the input terminals of the Meter.

Measuring AC or DC Current (see figure 12)

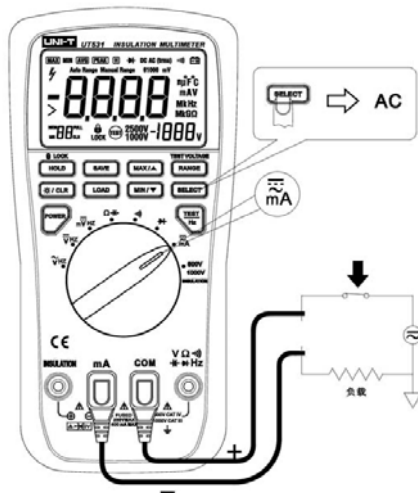

Figure 12.Measuring AC or DC Current

Warning

To avoid personal injury or damage to the Meter:

- Never attempt to make an in-circuit current measurement when the open-circuit potential to earth is greater than 600V.
- Inspect Meter's fuses before testing. Broken fuses may damage to the Meter or hurt yourselves
- Use the proper terminals, switch position, and range for your measurement.
- Never place the probes in parallel with circuit or component when the leads are plugged into the current terminals.

The current ranges are 60.00mA and 600.0mA.

To measure current, connect the Meter as follows:

1. Insert the red test lead into the **mA** terminal and the black test lead into the **COM** terminal.
2. Set the rotary switch to mA . DC Current is default. Press **SELECT** to toggle to AC current measurement mode.
3. Connect the test leads across with the object being measured.
The measured value shows on the display.
4. AC Current displays True RMS value.

Note:

- If the value of current to be measured is unknown, set the Meter to autoranging or use the maximum measurement position 600.0mA and reduce the range step by step until a satisfactory reading is obtained.
- For safety sake, when measuring high current, each measurement time must be less than 10 seconds with an interval more than 15 minutes.
- When Current measurement has been completed, disconnect the connection between the testing leads and the circuit under test, and remove the testing leads away from the input terminals of the Meter.

Measuring Frequency (see figure 13)

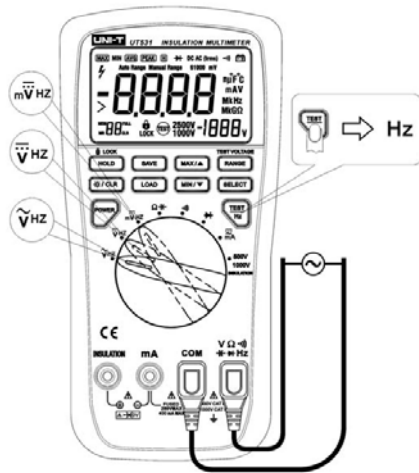

Figure 13.Measuring Frequency

- Press **H_z** button to select frequency measurement mode at m **V_~** or **V_~** or **V_~↔**. Press **H_z** to exit frequency measurement mode and return to the previous measurement mode.
- The maximum range of frequency is 1MHz.
- The signal attenuation is different from different measuring position and range. Therefore the required signal input amplitude and range may be different from different measuring position and range.
- It is recommended to use m**V_~↔** range which has higher input sensitivity.
- If the input amplitude is higher than 1V_{rms}, it is required to use **V_~↔** or **V_~** to carry out the measurement.
- When using current range to measure frequency, it is required to input signal more than 30% of full range. The reading obtained is only for reference.

Note:

- When Frequency measurement has been completed, disconnect the connection between the testing leads and the circuit under test, and remove the testing leads away from the input terminals of the Meter.

Measuring Temperature (UT532 and UT533 only) (see figure 14)

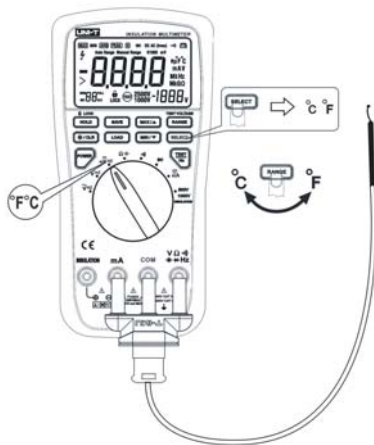

Figure 14.Measuring Temperature

 **Warning**

To avoid risk of shock do not connect thermocouple to electrically live circuits.

 **Caution**

To avoid possible damage to the Meter or other equipment, remember that while the Meter is rated for -40°C to 537°C (-40°F to 998°F), the included K-type thermocouple is rated for 260°C (500°F). For temperature out of that range, use a higher rated thermocouple.

To measure temperature, connect the Meter as follows:

1. Insert the red thermocouple into the $\mathbf{V}\Omega\mathbf{H}\mathbf{F}$ terminal and the black thermocouple into the **COM** terminal.
2. Set the rotary switch to mV.
3. Press **SELECT** to choose temperature range.
4. Press **RANGE** to toggle between degrees Celsius ($^{\circ}\text{C}$) or degrees Fahrenheit ($^{\circ}\text{F}$).
5. Place the thermocouple to the object being measured.
The measured value shows on the display.

Testing Insulation (see figure 15)

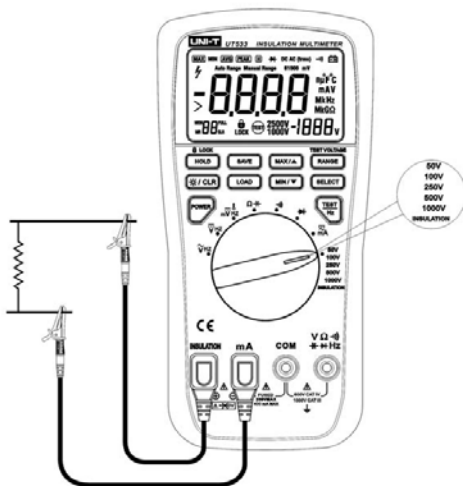

Figure 15. Testing Insulation

 **Warning**

Make sure the circuit to be tested is dead before taking measurement. Never measure the insulation resistance of live equipment or circuit. Never touch the circuit after measurement, as the capacitance to be saved on the circuit may cause electric shock.

Insulation tests should only performed on dead circuits. Check the fuse before testing.

To measure insulation resistance, set up the Meter as shown in Figure 15 and follow the steps below:

1. Insert the red short lead with alligator clip in the **INSULATION** input terminal and the black short lead with alligator clip in the **mA** input terminal.
2. Turn the rotary switch to **INSULATION** position.
3. Press **RANGE** to select the voltage.
4. Connect the probes to the circuit to be measured. There are two methods to start the insulation test:

- Press **HOLD** button to disable LOCK mode. Press and hold **TEST** to start the insulation test until **TEST** button is released
 - Press **HOLD** button to enter LOCK mode. Press **TEST** once to start the insulation test until pressing **HOLD** or **TEST** again to release LOCK mode.
5. Push and hold **TEST** button to start the test, the secondary display shows the test voltage applied to the circuit under test. The high voltage symbol along with a primary display showing the resistance in $M\Omega$ or $G\Omega$. The TEST icon appears on the lower portion of the display.
 6. When releasing the **TEST** button, LCD will not appear TEST icon. The resistance reading appears on the primary display until a new test is started or a different function or range is selected.

Caution

The following improper operating procedure may force the Meter to power off automatically. To avoid the danger of electric shock and damage to the Meter:

- Replace batteries as soon as battery indicator is on. Initiating high voltage when the battery indicator is on, which may force the Meter to power off.
- Must connect the probe to the circuit being measured before initiating high voltage.
- When under high voltage mode , never turn the rotary switch to other position.
- The testing time of small resistor or short circuit cannot exceed 20 seconds.
- At insulation testing mode with testing voltage initiated, auto power off feature will be disabled until un-initiating the testing voltage.

Cleaning

- Periodically wipe the case with a damp cloth and mild detergent. Do not use abrasives or solvents. Dirt or moisture in the terminals can affect readings.
- Turn the Meter off when it is not in use.
- Do not use or store the Meter in a place of humidity, high temperature, explosive, inflammable and strong magnetic field.
- The internal circuit of the Meter shall not be altered at will to avoid damage of the Meter and any accident.

Replacing the Batteries

Replace the batteries as shown in Figure 16. Follow the steps below to replace the batteries.

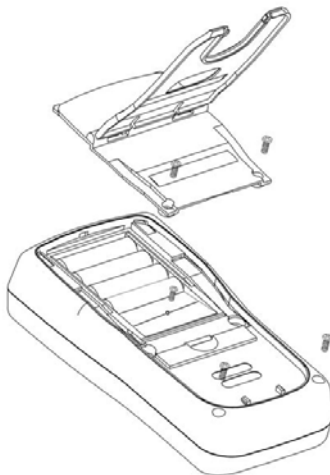



Figure 16. Replacing the Fuse and Battery

 **Warning**

To avoid shock, injury, or damage to the Meter:

- To avoid false readings, which could lead to possible electric shock or personal injury, replace the batteries as soon as the battery indicator  appears.
 - Turn the Meter off and remove the testing leads from the terminals.
1. Remove the two screws from the battery door by using a standard screwdriver.
 2. Open the battery door.
 3. Remove and replace the batteries.
6pcs of AA (AM3/LR6), standard capacity around 2450mAh.
 4. Rejoin the case bottom and battery compartment, and reinstall the screw.

Replacing the Fuse

Replace the fuse as shown in Figure 16. Follow the steps below to replace the batteries.

Warning



To avoid shock, injury, or damage to the Meter:

- **Use ONLY fuses with the amperage and voltage specified.**
 - **Turn the Meter off and remove the testing leads from the terminals.**
1. Remove the two screws from the battery door, two screws from the case bottom, one screw at the back of the battery.
 2. Open the battery door and the case bottom
 3. Remove the fuse by gently prying one end loose, and take out the fuse from its bracket.
 4. Install ONLY replacement fuses with identical amperage and voltage specified:
F1A 240V
 5. Rejoin the battery door and the case bottom, and reinstall the screws.
 6. Do not operate the Meter with the case opened.

Replacement of the fuse is seldom required. Buring of a fuse always results from improper operation.

Specifications

Table 6. General Specifications

Maximum Voltage Applied to any Terminal	1000V rms
 mA Input Terminal	1A / 240V Fast Fuse , High breaking capacity Fuse
Maximum Display	6000, Updates 5 times per second
Operating Temperature	0°C ~40°C (32°F~104°F)
Storage Temperature	-10°C ~50°C (14°F~122°F)
Relative Humidity	≤75% @ 0°C to below 31°C ≤50% @ 31°C to above 40°C
Altitude	Operating: 2000 meter Storage: 10000 meter
Batteries	Six AA 1.5V batteries AM3/LR6 (standard capacity around 2450mAh)
Low battery	LCD display 
Auto Power Off	The Meter will be automatically off when the Meter is not in use for more than 15 minutes
Size	97mm x 202mm x 46mm
Weight	Around 505 g (including batteries)

Electrical Specifications

Accuracy: $\pm(a \% \text{ of rdg} + b \text{ digits})$, guarantee for 1 year.

Operating Temperature: $23^{\circ}\text{C} \pm 5^{\circ}\text{C}$

Relative Humidity: $< 75\%$

AC Voltage Measurement

Range	Resolution	Accuracy		Input Protection
		50Hz ~60Hz	60Hz ~ 1kHz	
6.000V	1mV	$\pm (1\%+3)$	$\pm (2\%+3)$	1000V 
60.00V	10mV		$\pm (2\%+6)$	
600.0V	100mV			
1000V	1V	$\pm (2\%+3)$		

Remarks:

- Input Impedance: $\geq 10\text{M}\Omega$
- Displays effective value of sine wave
- Frequency Response: 50Hz~1kHz

DC Voltage Measurement

Range	Resolution	Accuracy	Input Protection
6.000V	1mV	± (0.3%+4)	1000V \approx
60.00V	10mV		
600.0V	100mV		
1000V	1V		

Remark:

- Input Impedance: $\geq 10M\Omega$

DC Millivolts Measurement

Range	Resolution	Accuracy	Input Protection
60.00mV	10 μ V	± (0.4%+4)	600Vp
600.0mV	100 μ V		

Remark:

- Input Impedance: $\geq 4000M\Omega$

AC Current Measurement

Range	Resolution	Accuracy	Input Protection
60.00mA	10 μ A	± (1.5%+2)	Fuse, Fast, 1A, 240V
600.0mA	100 μ A		

Remark:

- Displays True RMS value.
- Frequency Response 50Hz ~ 1kHz

DC Current Measurement

Range	Resolution	Accuracy	Input Protection
60.00mA	10 μ A	$\pm (1.0\%+2)$	Fuse, Fast, 1A, 240V
600.0mA	100 μ A		

Ohms Measurement

Range	Resolution	Accuracy	Input Protection
600.0 Ω	0.1 Ω	$\pm (0.9\%+2)$	600Vp
6.000k Ω	1 Ω		
60.00k Ω	10 Ω		
600.0k Ω	100 Ω		
6.000M Ω	1k Ω		
40.00M Ω	10k Ω	$\pm (1.5\%+3)$	

Capacitance Measurement

Range	Resolution	Accuracy	Input Protection
10.00nF	10pF	±(3%+5)	600Vp
100.0nF	100pF		
1000nF	1nF		
10.00μF	10 nF		
100.0μF	100nF		

Diode Test

- Resolution: 1mV
- Input Protection: 500Vp
- Open circuit voltage: around 3V
- Display approximate forward voltage drop nearest value.

Continuity Test

- Continuity Indication: Continuous audible tone for test resistance below 30Ω.
- Open Circuit Voltage: around 3V
- Input Protection: 500Vp
- Resolution: 0.1Ω

Temperature Measurement (UT532 and UT533 only)

Range	Resolution	Accuracy	Input Protection
-40°C~537°C	1°C	± (1%+10)	600Vp
-40°F~998°F	2°F	± (1%+18)	

Frequency Measurement

● At mV_{AC} Range

Range	Resolution	Accuracy	Input Protection
60.00Hz	0.01Hz	± (0.1%+3)	600Vp
600.0Hz	0.1Hz		
6.000kHz	1Hz		
60.00kHz	10Hz		
600.0kHz	100Hz		
1.000MHz	1kHz		

Remark:

- Input Sensitivity:
 - ≤ When 100kHz: ≤ 100mV rms
 - ≥ 30mV rms
 - > When 100kHz: ≥ 100mV rms
 - ≤ 30V rms

- ***At DCV/ACV Range***

Range	Accuracy	Input Protection
10Hz~100kHz	± (0.1%+3)	600Vp

Remark:

- Input amplitude: $\geq 600\text{mV rms}$

Insulation Specifications

- ***UT531***

Testing Voltages	Measurement Range	Resolution	Accuracy
500V (0% to 20%)	0.5MΩ ~ 99.9MΩ	0.1MΩ	± (3%+5)
	100MΩ ~ 500MΩ	1MΩ	
1000V (0% to 20%)	4.0MΩ ~ 99.9MΩ	0.1MΩ	
	100MΩ ~ 600MΩ	1MΩ	

Remark:

- Short-Circuit Test Current less than 2.0mA

- **UT532**

Testing Voltages	Measurement Range	Resolution	Accuracy
250V (0% to 10%)	0.2MΩ ~ 99.9MΩ	0.1MΩ	± (3%+5)
	100MΩ ~ 250MΩ	1MΩ	
500V (0% to 20%)	0.5MΩ ~ 99.9MΩ	0.1MΩ	
	100MΩ ~ 500MΩ	1MΩ	
1000V (0% to 20%)	4.0MΩ ~ 99.9MΩ	0.1MΩ	
	100MΩ ~ 999MΩ	1MΩ	
	1.00MΩ ~ 2.00GΩ	10MΩ	± (5%+5)

Remark:

- Short-Circuit Test Current less than 2.0mA

- **UT533**

Testing Voltages	Measurement Range	Resolution	Accuracy
50V (0% to 10%)	0.1MΩ ~ 50.0MΩ	0.1MΩ	± (3%+5)
100V (0% to 10%)	0.1~100.0MΩ	0.1MΩ	
250V (0% to 10%)	0.2MΩ ~ 99.9MΩ	0.1MΩ	
	100MΩ ~ 250MΩ	1MΩ	
500V (0% to 20%)	0.5MΩ ~ 99.9MΩ	0.1MΩ	
	100MΩ ~ 500MΩ	1MΩ	
1000V (0% to 20%)	4.0MΩ ~ 99.9MΩ	0.1MΩ	± (5%+5)
	100MΩ ~ 999MΩ	1MΩ	
	1.00GΩ ~ 2.00GΩ	10MΩ	

Remark:

- Short-Circuit Test Current less than 2.0mA

* END **

UNI-T®

UT531/UT532/UT533 : USERS MANUAL

UNI-T®

UNI-TREND TECHNOLOGY (CHINA) CO., LTD.

No6, Gong Ye Bei 1st Road,
Songshan Lake National High-Tech Industrial
Development Zone, Dongguan City,
Guangdong Province, China
Tel: (86-769) 8572 3888
<http://www.uni-trend.com>