

CJ6-4.5 (6V4.5AH)

Specification

Nominal Voltage	6V	
Nominal Capacity(20HR)	4.5AH	
Dimension	Length	70 ±1mm (2.76 inches)
	Width	47 ±1mm (1.85 inches)
	Container Height	100 ±2mm (3.94 inches)
	Total Height (with Terminal)	106 ±2mm (4.17 inches)
Approx Weight	Approx 0.81 kg (1.79lbs)	
Terminal	T1	
Container Material	ABS	
Rated Capacity	4.50 AH/0.225A	(20hr ,1.80V/cell,25°C/77°F)
	4.19 AH/0.419A	(10hr,1.80V/cell,25°C/77°F)
	3.85 AH/0.77A	(5hr,1.75V/cell,25°C/77°F)
	3.45 AH/1.15A	(3hr,1.75V/cell,25°C/77°F)
	2.65 AH/2.65A	(1hr,1.60V/cell,25°C/77°F)
Max. Discharge Current	67.5A (5s)	
Internal Resistance	Approx 25mΩ	
Operating Temp.Range	Discharge : -15~50°C (5~120°F)	
	Charge : 0~40°C (5~104°F)	
	Storage : -15~40°C (5~104°F)	
Nominal Operating Temp. Range	25 ±3°C (77 ±5°F)	
Cycle Use	Initial Charging Current less than 1.35A.Voltage	
	7.2V~7.5V at 25°C (77°F)Temp. Coefficient -15mV/°C	
Standby Use	No limit on Initial Charging Current Voltage	
	6.75V~6.9V at 25°C (77°F)Temp. Coefficient -10mV/°C	
Capacity affected by Temperature	40°C (104°F)	103%
	25°C (77°F)	100%
	0°C (32°F)	86%
Self Discharge	CJ series batteries may be stored for up to 6 months at 25°C (77°F) and then a freshening charge is required. For higher temperatures the time interval will be shorter.	



Applications

- ◆ All purpose
- ◆ Uninterruptable Power Supply(UPS)
- ◆ Electric Power System (EPS)
- ◆ Emergency backup power supply
- ◆ Emergency light
- ◆ Railway signal
- ◆ Aircraft signal
- ◆ Alarm and security system
- ◆ Electronic apparatus and equipment
- ◆ Communication power supply
- ◆ DC power supply
- ◆ Auto control system

Constant Current Discharge (Amperes) at 25 °C (77°F)

F.V/Time	5min	10min	15min	20min	30min	45min	1h	2h	3h	4h	5h	6h	8h	10h	20h
1.85V/cell	8.57	6.58	5.45	4.71	3.64	2.68	2.26	1.34	1.05	0.85	0.69	0.60	0.486	0.406	0.223
1.80V/cell	11.5	8.41	6.59	5.57	4.30	3.12	2.53	1.46	1.13	0.91	0.75	0.65	0.515	0.419	0.225
1.75V/cell	13.0	9.24	7.19	5.99	4.46	3.24	2.65	1.51	1.15	0.93	0.77	0.66	0.524	0.430	0.227
1.70V/cell	14.3	10.1	7.68	6.30	4.65	3.37	2.74	1.55	1.18	0.95	0.78	0.68	0.532	0.438	0.231
1.65V/cell	15.7	10.9	8.17	6.69	4.90	3.45	2.80	1.58	1.23	0.99	0.81	0.69	0.540	0.447	0.234
1.60V/cell	17.4	11.8	8.73	7.13	5.18	3.60	2.83	1.64	1.27	1.02	0.83	0.71	0.545	0.452	0.236

Constant Power Discharge (Watts) at 25 °C (77°F)

F.V/Time	5min	10min	15min	20min	30min	45min	1h	2h	3h	4h	5h	6h	8h	10h	20h
1.85V/cell	15.7	12.2	10.2	8.88	6.95	5.16	4.37	2.60	2.04	1.66	1.36	1.18	0.959	0.803	0.441
1.80V/cell	20.8	15.4	12.1	10.3	8.07	5.96	4.86	2.82	2.18	1.77	1.45	1.27	1.014	0.827	0.445
1.75V/cell	23.0	16.6	13.1	11.0	8.31	6.12	5.06	2.91	2.22	1.80	1.49	1.30	1.030	0.848	0.449
1.70V/cell	24.6	17.7	13.8	11.5	8.60	6.34	5.21	2.98	2.27	1.85	1.52	1.32	1.043	0.864	0.457
1.65V/cell	26.7	18.9	14.5	12.1	9.00	6.44	5.29	3.00	2.36	1.90	1.56	1.35	1.057	0.881	0.462
1.60V/cell	28.8	20.1	15.3	12.8	9.43	6.68	5.31	3.12	2.42	1.96	1.61	1.37	1.065	0.889	0.464

Dimensions

T1 Terminal

Unit: mm [inches]

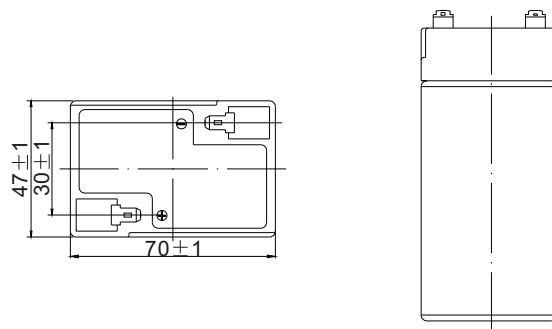
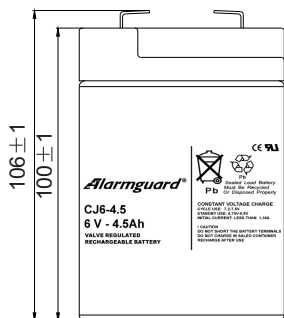
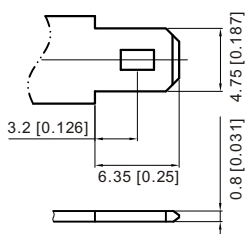

Discharge Characteristics

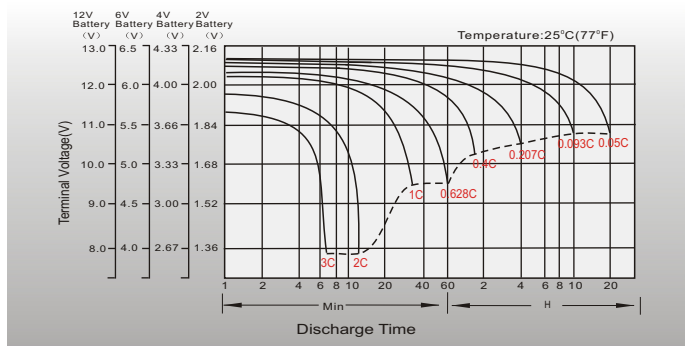

Float Charging Characteristics

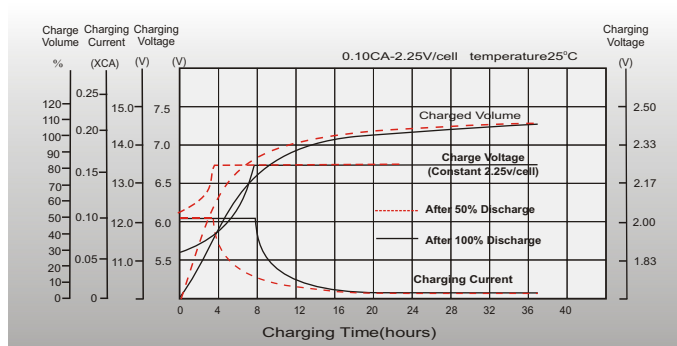

Temperature Effects in Relation to Batter Capacity

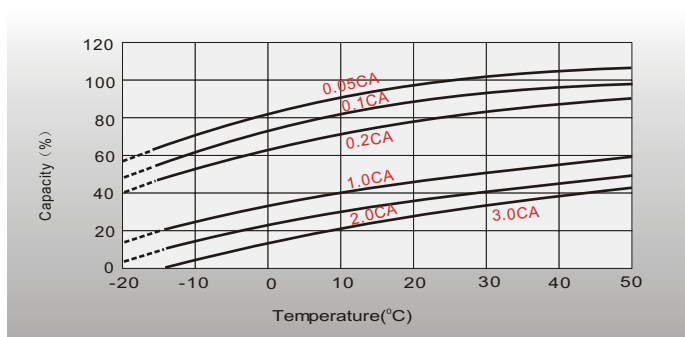

Effect of Temperature on Long Term Float Life

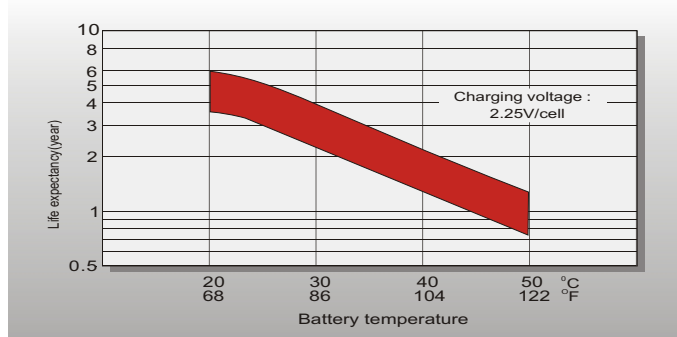

Cycle Life in Relation to Depth of Discharge

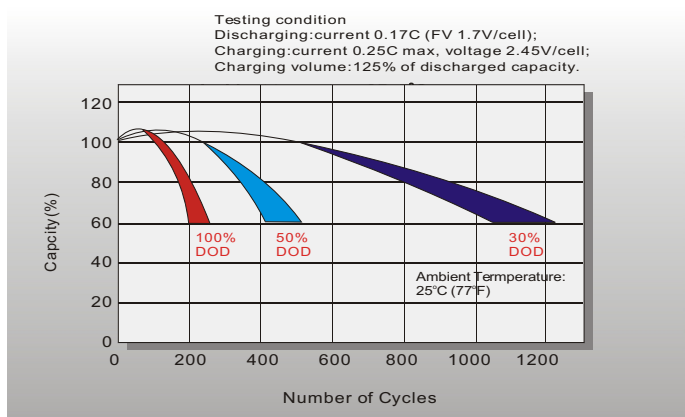

Self Discharge Characteristics

