

INSTRUCTION MANUAL



Intertek



Leakage Clamp Meter

CONTENTS

1. Safety information.....	25
1.1 Preliminary	25
1.2 Usage.....	26
1.3 Mark	27
1.4 Maintenance.....	27
2. Description.....	28
2.1 Part Name	29
2.2 Switch Button And Input Jack Description.....	30
2.3 LCD Display	31
3. Specifications	32
3.1 General	32
3.2 Technical indicators.....	33
4. Operating Guidance	36
4.1 Reading Hold	36
4.2 50Hz/60Hz Current Selection function	36
4.3 Maximum/Minimum Measurement Choice.....	36
4.4 Function Selection Function.....	37
4.5 Current Clearing Function	37
4.6 Automatic Power-Off	37

Leakage Clamp Meter

CONTENTS

4.7 Measurement Preparation.....	38
4.8 Current Measurement	38
4.9 Voltage Measurement	39
4.10 Resistance Measurement	40
4.11 Diode Measurement.....	40
4.12 Circuit Continuity Measurement.....	41
4.13 Capacitance Measurement	41
4.14 Temperature Measurement.....	42
5. Maintenance.....	42
5.1 Replace Battery.....	42
5.2 Replace Test Leads.....	43
6. Accessories	43

Leakage Clamp Meter

1. Safety Information

WARNING

The special attention should be paid when using the meter because the improper usage may cause electric shock and damage the meter. The safety measures in common safety regulations and operating instruction should be complied with when using. In order to make fully use of its functions and ensure safe operations please comply with the usage in this section carefully.

The meter is designed and manufactured according to safety requirements of EN 61010-1:2010, EN 61010-2-032, EN 61010-2-033 on electronic measuring instrument and hand held digital multipurpose meter. And conforms to UL STD.61010-1, 61010-2-032, 61010-2-033, Certified to CSA STD.C22.2 NO.61010-1, IEC STD 61010-2-032, IEC STD 61010-2-033. The product meets with the requirements of 600V CAT III and pollution degree 2.

All safety guidelines outlined should be followed otherwise the protection provided by the instrument may be impaired.

Warning symbols in the manual alert users of potential dangerous situations.

Precautions are to prevent the user from damaging the instrument or the test object.

1.1 Preliminary

- 1.1.1 When using the meter, the user should comply with standard safety rules:
 - General shock protection
 - Prevent misusing the meter
- 1.1.2 Please check for damage during transportation after receiving the meter.
- 1.1.3 If the meter is stored and shipped under hard conditions, please confirm if the meter is damaged.

Leakage Clamp Meter

- 1.1.4 Probe should be in good condition. Before use, please check whether the probe insulation is damaged and if the metal wire is bare.
- 1.1.5 Use the probe table provided with the meter to ensure safety. If necessary, replace the probe with another identical probe or one with the same level of performance.

1.2 Usage







- 1.2.1 When using, select the right function and measuring range.
- 1.2.2 Don't measure by exceeding indication value stated in each measuring range.
- 1.2.3 When measuring a circuit with the meter connected, do not contact with probe tip (metal part).
- 1.2.4 When measuring, if the voltage to be measured is more than 60 V DC or 30 V AC (RMS), always keep your fingers behind finger protection device
- 1.2.5 Do not measure voltage greater than 600V DC or AC(RMS).
- 1.2.6 In the manual measuring range mode, when measuring an unknown value, select the highest measuring range first.
- 1.2.7 Before rotating conversion switch to change measuring function, remove probe from the circuit to be measured.
- 1.2.8 Don't measure resistor, capacitor, diode and circuit connected to power.
- 1.2.9 During the test of currents, resistors, capacitors, diodes and circuit connections, be careful to avoid connecting the meter to a voltage source.
- 1.2.10 Do not measure capacitance before capacitor is discharged completely.
- 1.2.11 Do not use the meter in explosive gas, vapor or

Leakage Clamp Meter

dusty environments.

- 1.2.12 If you find any abnormal phenomena or failure on the meter, stop using the meter.
- 1.2.13 Unless the meter bottom case and the battery cover are completely fastened completely, do not use the meter.
- 1.2.14 Don't Store or use the meter in the conditions of direct sunlight, high temperature and high humidity.

1.3 Mark

	Note-Important safety information, refer to the instruction manual.
	Application around and removal from UNINSULATED HAZARDOUS LIVE conductors is permitted.
	Equipment protected throughout by double insulation or reinforced insulation.
	Conforms to UL STD. 61010-1, 61010-2-032, 61010-2-033; Certified to CSA STD C22.2 NO. 61010-1, 61010-2-032, 61010-2-033
	Complies with European (EU) safety standards
	Earth (ground) TERMINAL

CAT III: MEASUREMENT CATEGORY III is applicable to test and measuring circuits connected to the distribution part of the building's low-voltage MAINS installation.

1.4 Maintenance

- 1.4.1 Don't try to open the meter bottom case to adjust or repair. Such operations can only be performed by technicians who fully understand the meter and electrical shock hazard.
- 1.4.2 Before opening the meter bottom case or battery

Leakage Clamp Meter

cover, remove probe from the circuit to be measured.

- 1.4.3 To avoid wrong readings causing electric shock, when "" appears on the meter display, replace the battery immediately.
- 1.4.4 Clean the meter with damp cloth and mild detergent. Do not use abrasives or solvents.
- 1.4.5 Power off the meter when the meter is not used. Switch the measuring range to "**OFF**" position.
- 1.4.6 If the meter is not used for long time, remove the battery to prevent the meter being damaged.

2. Description

- The meter is a portable, professional measuring instrument with LCD display for easy reading by users. Measuring range switch is operated by single hand for easy operation with overload protection and low battery indicator. It is an ideal multifunction meter for professionals, factories, schools, fans and family use.
- The meter is used for AC leakage current, AC voltage, DC voltage, resistance, capacitance, circuit connection, diode and temperature test.
- The meter has reading hold function.
- The meter has maximum measuring function.
- The meter has minimum measuring function.
- The meter has auto power-off function.

Leakage Clamp Meter

2.1 Part Name

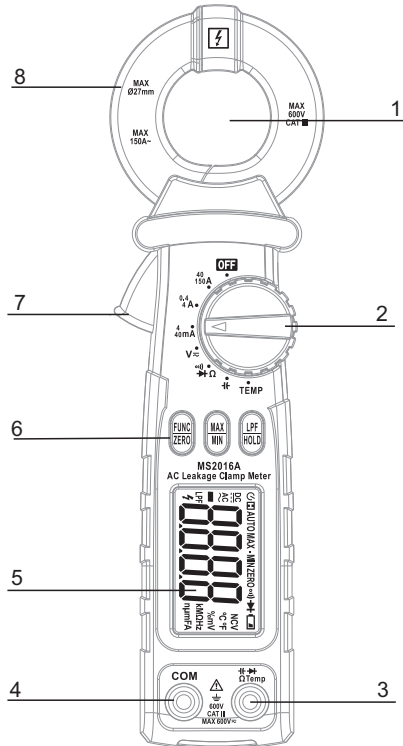

Leakage Clamp Meter

- (1) The central of the clamp head
- (2) Transfer switch
- (3) Resistance, capacitance, voltage, diode and continuity input jack
- (4) Common end jack
- (5) LCD display
- (6) Function choice button
- (7) Trigger
- (8) Current clamp head: used for leakage current measurement.

2.2 Switch, Button and Input jack description

HOLD/LPF button: used for reading hold and LPF(50Hz/60Hz) function control.

FUNC/ZERO button: used for measuring function switch and current clearing function control.

MAX/MIN button: used for maximum/minimum measurement function switch and leakage current measuring.

OFF position: used for shutting off the power.

INPUT jack: voltage, resistance, capacitance, diode, circuit connection input wire connecting and temperature terminal.

COM jack: voltage, resistance, capacitance, diode, circuit connection common wire connecting and temperature terminal.

Transfer switch: used for selecting function and measuring range.

Leakage Clamp Meter

2.3 LCD Display

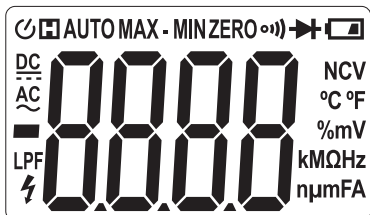

	Alternating current or voltage, direct voltage
	Diode, continuity
AUTO	Automatic measuring range mode
MAX	Maximum measuring state
MIN	Minimum measuring state
	Automatic power-off state
	Low battery
H	Reading hold state
V	Volt(voltage)
A	Amperes(Current)
nF,μF,mF	Nano, farad, Microfarad, Millifarad
Ω,kΩ,MΩ	Ohm, Kilohm, Megohm(resistance)
ZERO	Current clearing state
°C °F	Temperate measuring state
LPF	Low pass filter (50Hz/60Hz) function state

Leakage Clamp Meter

3. Specifications

The meter should be recalibrated under the condition of 18°C~28°C, relative humidity less than 75% with the period of one year.

3.1 General

Automatic measuring range and manual measuring range.

Full measuring range overload protection.

The maximum allowable voltage between measurement end and ground: 600V DC or AC(RMS)

Operational height: maximum 2000m

Display: LCD

Displayed maximum value: 4000 counts.

Polarity indication: automatical indication, “-” means negative polarity.

Exceeding measuring range display: “OL”.

Sampling rate: about 3 times/sec.

Unit display: has function and power unit display.

Auto off time: 30 min

Power supply: 2x1.5V AAA Batteries

Battery undervoltage indication: LCD displays “” symbol.

Temperature coefficient: less than 0.1×accuracy/°C

Operational temperature: 18°C~28°C

Storage temperature: -10°C~50°C

Dimension: 213×62×38mm (8.4x2.44x1.5in)

Weight: about 238g(8.4oz)-include battery

Leakage Clamp Meter

3.2 Technical Indicators

Environment temperature: 23±5°C, relative humidity (RH): <75%

3.2.1 AC Current

Measuring range	Resolution	Accuracy	
		LPF(50Hz/60Hz)	Wide(40Hz~1kHz)
4mA	0.001mA	±(2.0% +10)	±(3.0% +5)
40mA	0.01mA		
400mA	0.1mA	±(2.0% +5)	±(3.0% +3)
4A	0.001A		
40A	0.01A	±(2.0% +10)	±(3.0% +5)
150A	0.1A		

- Maximum input current: 150AAC
- Frequency range: 40~1kHz

Note:

When clamping 2 or more cables to measure leakage current, the result may be interfered by the current on the cable. The deviation may be more than 1mA when the current on the cable is 1 Amp.

3.2.2 DC Voltage

Measuring range	Resolution	Accuracy
4V	0.001V	±(0.5% reading + 4 digits)
40V	0.01V	
400V	0.1V	
600V	1V	

- Input impedance: 10MΩ
- Maximum input voltage: 600V DC or AC(RMS)

Leakage Clamp Meter

Note:

In the small voltage measuring range, the probe is not connected with the circuit to be tested, and the meter may have fluctuating readings, which is normal and caused by the meter's high sensitivity. This does not affect actual measurement results.

3.2.3 AC Voltage

Measuring range	Resolution	Accuracy
4V	0.001V	±(1.0% reading + 3 digits)
40V	0.01V	
400V	0.1V	
600V	1V	

- Input impedance: 10MΩ
- Maximum input voltage: 600V DC or AC(RMS)
- Frequency range: 40~1kHz(sine wave)

Note:

In the small voltage measuring range, the probe is not connected with the circuit to be tested, and the meter may have fluctuating readings, which is normal and caused by the meter's high sensitivity. This does not affect actual measurement results.

3.2.4 Resistance

Measuring range	Resolution	Accuracy
400Ω	0.1Ω	±(0.8% reading + 3 digits)
4kΩ	0.001kΩ	
40kΩ	0.01kΩ	
400kΩ	0.1kΩ	
4MΩ	0.001MΩ	
40MΩ	0.01MΩ	

±(1.0% reading + 3 digits)

Leakage Clamp Meter

- Open circuit voltage: about 1.0V
- Overload protection: 600V DC or AC (RMS)

3.2.5 Circuit Continuity Test

Measuring range	Resolution	Accuracy
	0.1Ω	If the resistance of circuit to be measured is less than 40Ω, the meter's built-in buzzer may sound.

- Overload protection: 600V DC or AC (RMS)

3.2.6 Temperature Test

Measuring range	Resolution	Accuracy
-20°C~0°C/-4°F~32°F	1°C/1°F	±(3.0% reading + 5 digits)
-0°C~400°C/32°F~752°F		±(1.5% reading + 5 digits)
400°C~1000°C/752°F~1832°F		±(3.0% reading + 5 digits)

- Overload protection: 600V DC or AC (RMS)
- The parameter does not contain thermocouple errors

3.2.7 Capacitance

Measuring range	Resolution	Accuracy
40.00nF	0.01nF	±(3.0% reading + 8 digits)
400.0nF	0.1nF	
4.000μF	0.001μF	
40.00μF	0.01μF	
400.0μF	0.1μF	
4.000mF	0.001mF	
40.00mF	0.01mF	

Leakage Clamp Meter

- Overload protection: 600V DC or AC (RMS)
- The parameter does not contain errors caused by base capacitance and capacitance probe

3.2.8 Diode Test

Measuring range	Resolution	Function
	0.001V	Display approximate diode forward voltage value

- Forward DC current is about 1mA
- Backward DC voltage is about 3.2V
- Overload protection: 600V DC or AC (RMS)

4. Operating Guidance

4.1 Reading Hold Function

In the process of measurement, if reading hold is required, press “**LPF/HOLD**” key, the value on the display will be locked. press “**LPF/HOLD**” key again to cancel reading hold state.

4.2 50Hz/60Hz Current Selection Function

In the process of current mode, press “**LPF/HOLD**” key more than 2 sec, the meter will enter the LPF(50Hz/60Hz) current measurement.

4.3 Maximum/Minimum Measurement Function

- 1) Press “**MAX/MIN**” key to enter MAX mode, the meter will enter maximum measurement value; press “**MAX/MIN**” key again, the meter will enter minimum value measurement state; press “**MAX/MIN**” key

Leakage Clamp Meter

- to repeat the above operations by recycling.
- 2) If the user presses “**MAX/MIN**” key more than 2 sec, the meter will restore normal measuring range.

Note:

- 1) When the meter is in the maximum/minimum value measurement state, it is in manual measuring range mode.
- 2) When the meter is in the temperature measurement state, it can't switch to maximum/minimum value measurement mode.

4.4 Function Selection Function

- 1) In the resistance mode, press “**FUNC/ZERO**” button, it will switch among resistance, diode and continuity detection by recycling.
- 2) In the voltage mode, press “**FUNC/ZERO**” button to switch between AC and DC.
- 3) In the temperature mode, press “**FUNC/ZERO**” button to switch between celsius(°C) and fahrenheit (°F) degree.

4.5 Current Clearing Function

In the current mode, press “**FUNC/ZERO**” key more than 2 sec, the meter will clear the display of current value.



4.6 Automatic Power-Off

- 1) If there is no operation during any 30 minutes after turning the machine on, the meter will enter suspended state, automatically powering off to save the battery. Within 1 minute before shutdown, buzzer will sound five times. The meter will then enter a dormant state.
- 2) After automatic power-off, press “**FUNC/ZERO**” key,

Leakage Clamp Meter

- the meter will turn on again.
- 3) If the user holds “**FUNC/ZERO**” key when powering on, it will cancel automatic power-off function.

4.7 Measurement Preparation

- 1) Turn the transfer switch to turn on the power. When battery voltage is low (about 2.4V), LCD displays “” symbol, replace the battery.
- 2) “” symbol means that input voltage or current should not be more than the specified value, which is to protect the internal line from damage.
- 3) Place transfer switch to required measuring function and range.
- 4) When connecting line, first connect the common test line, then connect charged test line. When removing line, remove charged test line first.

4.8 Current Measurement

Warning

Electric shock hazard. Remove the probe measuring with current clamp.

- 1) Measuring switch is placed to position A. At this time, the meter is in AC current measurement state. Choose appropriate measuring range.
- 2) Hold the trigger, open clamp head, clip one lead of measurement circuit to be tested in the clamp.
- 3) Read the current and frequency value on the LCD display.

Note:

- 1) Clamping two or more leads of circuit to be tested simultaneously will not get the correct measuring results.

Leakage Clamp Meter

- 2) To get accurate reading, connect the lead to be tested at the center of current clamp.
- 3) "⚠" indicates that maximum input AC current is 150A.
- 4) Do not touch or hand hold position over protective barrier, when measure current.

4.9 Voltage Measurement

⚠Warning

Electric shock hazard.

Pay special attention to avoid shock when measuring high voltage.

Do not input voltage more than 600V DC or AC (RMS)

- 1) Insert black probe to "COM" jack, insert red probe to "INPUT" jack, choose appropriate measuring range.
- 2) Measuring switch is placed to position V_{\sim} . At this time, the meter is in the AC Voltage measurement state. To measure DC Voltage, press "FUNC/ZERO" button to enter DC Voltage measurement state.
- 3) Connect the probe with voltage source or both ends of load in parallel for measurement.
- 4) Read the voltage and frequency on the LCD.

Note:

- 1) In the small voltage measuring range, the probe is not connected with the circuit to be tested, and the meter may have fluctuating readings, which is normal and caused by the meter's high sensitivity. When the meter is connected with the circuit to be tested, you will get actual measured value.
- 2) In the relative measurement mode, automatic measuring range is invalid.

Leakage Clamp Meter

- 3) "⚠" indicates that maximum input voltage is 600V DC or AC(RMS).
- 4) If the readings measured by the meter is more than 600V DC or AC (RMS), it will send out "beep" alarm.

4.10 Resistance Measurement

⚠Warning

Electric shock hazard.

When measuring circuit impedance, determine that the power supply is disconnected and the capacitor in the circuit is completely discharged.

- 1) Insert black probe to "COM" jack, insert red probe to "INPUT" jack.
- 2) Measuring switch is placed to position $\rightarrow \Omega$. At this time, the meter is in the measurement state.
- 3) Connect the probe to the both ends of resistor or circuit to be tested for measurement.
- 4) LCD will show readings.

Note:

- 1) When the input end is open, LCD shows "OL" outrage state.
- 2) When the resistance to be tested $> 1M\Omega$, the meter reading will stabilize after a few seconds, which is normal for high resistance readings.

4.11 Diode Measurement

- 1) Insert black probe to "COM" jack, insert red probe to "INPUT" jack.
- 2) Measuring switch is placed to position $\rightarrow \Omega$.
- 3) Press "FUNC/ZERO" key to switch to $\rightarrow \nabla$ measuring state.

Leakage Clamp Meter

- 4) Connect the red probe to diode anode and connect the black probe to diode cathode to make test.
- 5) Read on the LCD.

Note:

- 1) What the meter shows is approximation of diode forward voltage drop.
- 2) If the probe has reverse connection or the probe is open, the LCD will show "OL".

4.12 Circuit Continuity Measurement

Warning

Electric shock hazard.

When measuring circuit continuity, determine that the power supply is disconnected and the capacitor in the circuit is completely discharged.

- 1) Insert black probe to "COM" jack, insert red probe to "INPUT" jack.
- 2) Measuring switch is placed to position $\rightarrow \Omega$.
- 3) Press "FUNC/ZERO" key to switch to $\rightarrow \Omega$) circuit continuity measuring state.
- 4) Connect the probe to the both ends of circuit to be tested for measurement.
- 5) If the resistance of circuit to be measured is less than 50Ω , the meter's built-in buzzer may sound.
- 6) Read the circuit resistance value on the LCD.

Note:

If the probe is open or circuits resistance to be tested is more than 400Ω , the display will show "OL".

4.13 Capacitance Measurement

Leakage Clamp Meter

Warning

Electric shock hazard.

To avoid electric shock, before measuring capacitance, discharge capacitance completely.

- 1) Insert black probe to "COM" jack, insert red probe to "INPUT" jack.
- 2) Measuring switch is placed to position $\rightarrow C$.
- 3) After discharging capacitance completely, connect the probe to the both ends of capacitor to be tested for measurement.
- 4) Read the capacitance on the LCD.

Note:

To improve the accuracy below 1nF measuring value, subtract the distributed capacitance of meter and cable.

4.14 Temperature Measurement

- 1) Measuring switch is placed to position TEMP.
- 2) Connect negative and positive end of K-type thermocouple to "COM" jack and "INPUT" jack.
- 3) Place K-type thermocouple to the object or environment to be measured.
- 4) Read measured result from LCD display.

5. Maintenance

5.1 Replacing The Batteries

WARNING

To avoid electric shock, make sure that the test leads have been clearly move away from the circuit under measurement before opening the battery cover of the meter.

Leakage Clamp Meter

WARNING

Do not mix old and new batteries. Do not mix alkaline, standard (carbon-zinc), or rechargeable (ni-cad, ni-mh, etc) batteries.

- 5.1.1 If the sign “  ” appears, it means that the batteries should be replaced.
- 5.1.2 Loosen the fixing screw of the battery cover and remove it.
- 5.1.3 Replace the exhausted batteries with new ones.
- 5.1.4 Put the battery cover back and fix it again to its origin form.

Note:

Do not reverse the polarity of the batteries.

5.2 Replacing Test Leads

Replace test leads if leads become damaged or worn.

WARNING

Use meet EN 61010-031 standard, rated CAT III 600V, MAX 10A or better test leads.

6. Accessories

1)	Probe		One pair
2)	User's Manual		1pcs
3)	Battery	1.5V AAA Battery	2pcs
4)	Thermocouple	K-type	1pcs



MGL EUMAN, S.L.

Parque Empresarial de Argame,
C/Picu Castiellu, Parcelas i-1 a i-4
E-33163 Argame, Morcín
Asturias, España, (Spain)

