



**MOTORCYCLE
& POWERSPORT
BATTERY**

APPLICATION
& SPECIFICATION
GUIDE



World number one for motorcycle batteries

The range



High Performance Maintenance Free

If high power is top priority in a replacement battery, look to Yuasa's High Performance Maintenance Free batteries. Yuasa means more power, less maintenance and longer life. Yuasa's High Performance Maintenance Free batteries are your best choice for motorcycles, utility vehicles, scooters, ATVs, riding mowers, personal watercraft and snowmobiles.

All the features of a standard maintenance free.
PLUS INCREASED POWER – Up to 30% more cranking amps.
Thanks to a radial grid design and additional plates.

High Performance Maintenance Free Start-Stop

Designed and constructed to meet the special needs of newly developed start-stop systems in motorcycles and scooters:

- **Used by major manufacturers**
- **Original Equipment** quality, performance & specification
- **Permanently sealed** VRLA battery
- **Small size** with high performance
- **Quick recharge** capability and high capacity



Maintenance Free VRLA

VRLA (Valve Regulated Lead Acid) means a battery that's perfect for people who have better things to do than battery maintenance! Our permanently sealed VRLA battery never needs refilling; however, it still needs periodic charging. Ideal for motorcycles, scooters, ATVs, riding mowers and personal watercraft.

- **Spill-proof design** means virtually no possibility of leaks
- **Advanced lead-calcium technology** pumps up starting power
- **Sulphation retardant** dramatically reduces battery-killing plate sulphation
- **Long lasting** which means Yuasa's High Performance Maintenance Free batteries will last up to three times longer than conventional batteries
- **Exceptional resistance to vibration** makes Yuasa the most reliable battery on the market today
- **VRLA batteries hold voltage longer** and need less charging in standby or storage mode



YuMicron CX

For increased power, less maintenance and longer life, YuMicron CX is the battery of choice. The first motorcycle battery built on lead-calcium technology, YuMicron CX is specially designed for today's big, complex vehicles, where higher cranking power is a must. It delivers all the features of the standard YuMicron – plus...

- **Unique CX design** for higher cold cranking amps
- **Lead-calcium technology** reduces water loss – and servicing – by 66% compared to lead antimony
- **And, CX substantially reduces self-discharge** – for longer time between charges



YuMicron

Personal watercraft, snowmobiles and ATVs make special demands – and YUASA's YuMicron Battery meets them head-on. The high-tech, power-boosting design also makes YuMicron ideal for accessory-laden touring bikes and modified vehicles.

- **Heavy duty glass mat** resists vibration damage
- **Special thin separator** packs in extra plates, delivers up to 30% more cranking power than conventional types
- **Through-the-wall intercell connector** minimises internal resistance, maximises power
- **Sulphate Stop** curbs plate sulphation – and provides longer life

Can't find your vehicle listed?
Visit www.yuasa.com for our latest application data

Contents

| | |
|---------------------------------------|---------|
| Features and Benefits | 5 |
| Specifications | 6 - 9 |
| Terminal Configurations | 10 |
| Battery Upgrade Cross Reference Chart | 11 |
| YTZ® Batteries from Yuasa | 12 - 13 |
| Battery Supplier Cross Reference | 14 - 15 |
| Acid bottles | 15 |

Applications



| | |
|------------------------|----------|
| Motorcycle and Scooter | 16 - 107 |
|------------------------|----------|



| | |
|-----|-----------|
| ATV | 108 - 115 |
|-----|-----------|



| | |
|------------|-----------|
| Snowmobile | 116 - 120 |
|------------|-----------|



| | |
|-----------------|-----------|
| Utility Vehicle | 120 - 121 |
|-----------------|-----------|



| | |
|---------------------|-----------|
| Personal Watercraft | 122 - 123 |
|---------------------|-----------|



| | |
|------------------|-----------|
| Garden Machinery | 124 - 129 |
|------------------|-----------|

DISCLAIMER

The replacement battery information published in this book has been obtained from the equipment manufacturers listed, except as otherwise noted. Users are cautioned that the information contained in this book was the most current information provided to us at the time of publication. The information is subject to change upon notice from equipment manufacturers or field experience. Users should always use the most current edition of the Yuasa Battery Applications and Specifications.

Yuasa expressly denies any responsibility for the accuracy of the information provided to us. While we have made every effort to accurately catalogue the replacement battery information contained in this book, Yuasa denies any liability for damage caused as a consequence of using the information in this book. Users should also attempt to obtain replacement battery information from the equipment manufacturer's user manual or service department for their specific application.

Features & Benefits

| Component | Features | Benefits |
|--|--|---|
| Cast Grid | Special Grid Design | Severe vibration resistance & improved conductivity |
| Active Material | Proprietary Formulation | Reduced shedding, maximum utilisation, & long service life |
| Pasted Plates | Specified Thickness & Weight | Ensures vibration resistance through precise compression & proper service life through specified active material balance |
| Dry-Charged Plates | Tank Formed & Dried Plates | Properly dried plates in a sealed battery have a virtually limitless shelf-life, while still retaining 70-80% state of charge when initially filled with acid |
| Top Lead Connections | Through-Partition Construction, Large Straps | Shorter current path for increased electrical conductivity & higher starting currents, heavier parts for maximum durability |
| Case-Cover Seal | Thermal Bonded Plastic | Air tight seal to prevent air ingress & acid seepage |
| Terminal-Cover Seal | Patented Poly-Seal Terminal | Eliminates acid seepage, reduces corrosion, & extends battery life |
| Case & Cover | Polypropylene | Superior resistance to gasoline & oil, impact resistant in extreme weather conditions |
| Additive | Sulphate Stop (Some models) | Sulphate stop added to reduce the solubility of lead into the acid, which then reduces battery sulphation potential |
| YuMicron | | |
| Separator | Leaf or Envelope Separator | Polyethylene with glass mat sheet bonded for compression to withstand severe vibration conditions |
| YTX | | |
| Separator | Absorbed Glass Mat | Absorbs acid while creating cell compression for extreme vibration resistance |
| Top Lead Alloy | Calcium Alloy | Increased weld strength & severe vibration resistance |
| Vent System | Valve & Flame Arrestor | Valve relieves excess pressure to prevent bursting, flame arrestor prevents internal combustion |
| High Performance Maintenance Free | | |
| Grid System | Computer-Designed Radial Grids | Increased conductivity for higher starting wattage, increased vibration resistance |
| Separator | Puncture Resistant AGM Material | High puncture resistant separator for increased service in high vibration applications |

World number one for motorcycle batteries

Specifications

| Battery Type | NOTE | Pack Type | Capacity Ah (10HR) | Capacity Ah (20HR) | Dimensions - mm (\pm 2mm) | | | Weight with Acid (Kg) | Acid Volume (Litre) | Charge Current (Amps) | CCA* @ -18°C | Terminal Type (refer to page 10) | Assembly Figure |
|--------------|------|-----------|--------------------|--------------------|------------------------------|---|---|-----------------------|---------------------|-----------------------|--------------|----------------------------------|-----------------|
| | | | | | L | W | H | | | | | | |

HIGH PERFORMANCE MAINTENANCE FREE

| | | | | | | | | | | | | | |
|---------------|-------|-------|------|------|-----|-----|-----|------|------|-----|-----|----|--|
| YTX14AH-BS | (ii) | CP | 12 | 12.6 | 134 | 89 | 166 | 4.9 | 0.66 | 1.2 | 210 | 4 | |
| YTX14AHL-BS | | CP | 12 | 12.6 | 134 | 89 | 166 | 4.9 | 0.66 | 1.2 | 210 | 4 | |
| YTX14H-BS | | CP | 12 | 12.6 | 150 | 87 | 145 | 4.8 | 0.69 | 1.2 | 240 | 4 | |
| YTX20CH-BS | | CP | 18 | 18.9 | 150 | 87 | 161 | 6.1 | 0.82 | 1.8 | 270 | 4 | |
| YTX20H-BS | | CP | 18 | 18.9 | 175 | 87 | 155 | 6.3 | 0.93 | 1.8 | 310 | 4 | |
| YTX20HL-BS | | CP | 18 | 18.9 | 175 | 87 | 155 | 6.3 | 0.93 | 1.8 | 310 | 4 | |
| YTX20HL-BS-PW | (i) | CP | 18 | 18.9 | 175 | 87 | 175 | 6.3 | 0.93 | 1.8 | 310 | 4 | |
| YTX24HL-BS | | CP | 21 | 22.1 | 205 | 87 | 162 | 7.9 | 0.99 | 2.1 | 350 | 4 | |
| YTZ4V | | CP | 3 | 3.2 | 113 | 70 | 85 | 1.6 | 0.18 | 0.3 | 64 | 5 | |
| YTZ5S | | CP/WC | 3.5 | 3.7 | 115 | 72 | 86 | 1.6 | 0.19 | 0.1 | 65 | 5 | |
| YTZ6V | | CP | 5 | 5.3 | 113 | 70 | 105 | 2.0 | 0.5 | 0.5 | 90 | 5 | |
| YTZ7S | | WC | 6 | 6.3 | 113 | 70 | 105 | 2.1 | N/A | 0.6 | 130 | 5 | |
| YTZ7V | | WC | 6 | 6.3 | 113 | 70 | 120 | 2.5 | 0.34 | 0.6 | 105 | 5 | |
| YTZ8V | | WC | 7 | 7.4 | 113 | 70 | 130 | 2.7 | N/A | 0.7 | 120 | 5 | |
| YTZ10S | | WC | 8.6 | 9.1 | 150 | 87 | 93 | 3.2 | N/A | 0.9 | 190 | 11 | |
| YTZ12S | | WC | 11 | 11.6 | 150 | 87 | 110 | 3.7 | N/A | 1.1 | 210 | 11 | |
| YTZ14S | | WC | 11.2 | 11.8 | 150 | 87 | 110 | 3.9 | N/A | 1.1 | 230 | 11 | |
| GYZ16H | | WC | 16 | 16.8 | 150 | 87 | 145 | 5.6 | N/A | 1.6 | 240 | 5 | |
| GYZ16HL | | WC | 16 | 16.8 | 150 | 87 | 145 | 5.6 | N/A | 1.6 | 240 | 5 | |
| GYZ20L | | WC | 20 | 21.1 | 175 | 87 | 155 | 6.9 | N/A | 2.0 | 250 | 4 | |
| GYZ20H | | WC | 20 | 21.1 | 175 | 87 | 155 | 7.1 | N/A | 2.0 | 320 | 14 | |
| GYZ20HL | | WC | 20 | 21.1 | 175 | 87 | 155 | 7.1 | N/A | 2.0 | 320 | 14 | |
| GYZ32HL | | WC | 32 | 33.7 | 166 | 126 | 175 | 11.2 | N/A | 3.2 | 500 | 14 | |
| YIX30L | | WC | 30 | 31.6 | 166 | 126 | 175 | 9.9 | N/A | 3.0 | 400 | 5 | |
| YIX30L-PW | (iii) | WC | 30 | 31.6 | 166 | 126 | 175 | 9.9 | N/A | 3.0 | 400 | 5 | |
| YIX30L-BS | | CP | 30 | 31.6 | 166 | 126 | 175 | 9.9 | 1.40 | 3.0 | 400 | 5 | |
| YIX30L-BS-PW | (iii) | CP | 30 | 31.6 | 166 | 126 | 175 | 9.9 | 1.40 | 3.0 | 400 | 5 | |

HIGH PERFORMANCE MAINTENANCE FREE START-STOP

| | | | | | | | | | | | | | |
|-------|--|----|---|-----|-----|----|-----|-----|------|-----|-----|---|--|
| YTZ6V | | CP | 5 | 5.3 | 113 | 70 | 105 | 2.0 | 0.5 | 0.5 | 90 | 5 | |
| YTZ7V | | WC | 6 | 6.3 | 113 | 70 | 120 | 2.5 | 0.34 | 0.6 | 105 | 5 | |
| YTZ8V | | WC | 7 | 7.4 | 113 | 70 | 130 | 2.7 | N/A | 0.7 | 120 | 5 | |

MAINTENANCE FREE

| | | | | | | | | | | | | | |
|------------|--|-------|------|------|-----|----|------|-----|------|-----|-----|----|--|
| YTR4A-BS | | CP | 2.3 | 2.4 | 114 | 49 | 86 | 1.1 | 0.14 | 0.3 | 45 | 12 | |
| YT4B-BS | | CP | 2.3 | 2.4 | 114 | 39 | 86.5 | 1.1 | 0.12 | 0.3 | 40 | 13 | |
| YT4L-BS | | CP | 3 | 3.2 | 114 | 71 | 86 | 1.6 | 0.18 | 0.4 | 40 | 5 | |
| YTX4L-BS | | CP | 3 | 3.2 | 114 | 71 | 86 | 1.4 | 0.18 | 0.4 | 50 | 5 | |
| YT5A | | WC | 5 | 5.3 | 121 | 62 | 131 | 2.0 | N/A | 0.5 | 70 | 6 | |
| YTX5L-BS | | CP | 4 | 4.2 | 115 | 72 | 107 | 2.0 | 0.24 | 0.5 | 80 | 5 | |
| YT6A | | WC | 6 | 6.3 | 121 | 62 | 131 | 2.2 | N/A | 0.6 | 80 | 6 | |
| YT7B-BS | | CP/WC | 6.5 | 6.8 | 150 | 65 | 93 | 2.7 | 0.31 | 0.7 | 110 | 11 | |
| YTX7A-BS | | CP | 6 | 6.3 | 150 | 87 | 93 | 2.6 | 0.33 | 0.6 | 105 | 5 | |
| YTX7L-BS | | CP | 6 | 6.3 | 115 | 72 | 132 | 2.5 | 0.33 | 0.6 | 100 | 5 | |
| YT9B-BS | | CP/WC | 8 | 8.4 | 150 | 70 | 105 | 3.0 | 0.4 | 0.8 | 120 | 11 | |
| YTX9-BS | | CP | 8 | 8.4 | 152 | 87 | 107 | 3.1 | 0.4 | 0.8 | 135 | 5 | |
| YT12A-BS | | CP/WC | 10 | 10.5 | 150 | 87 | 105 | 3.5 | 0.5 | 1.0 | 175 | 5 | |
| YT12B-BS | | CP/WC | 10 | 10.5 | 150 | 69 | 130 | 4.1 | 0.5 | 1.0 | 210 | 11 | |
| YTX12-BS | | CP | 10 | 10.5 | 150 | 87 | 130 | 4.2 | 0.6 | 1.0 | 180 | 5 | |
| YT14B-BS | | CP/WC | 12 | 12.6 | 150 | 70 | 145 | 4.6 | 0.6 | 1.2 | 210 | 11 | |
| YTX14-BS | | CP | 12 | 12.6 | 150 | 87 | 145 | 4.6 | 0.69 | 1.2 | 200 | 5 | |
| YTX14L-BS | | CP | 12 | 12.6 | 150 | 87 | 145 | 4.6 | 0.69 | 1.4 | 200 | 5 | |
| YTX15L-BS | | CP | 13 | 13.7 | 175 | 87 | 130 | 4.8 | 0.69 | 1.3 | 230 | 4 | |
| YTX16-BS | | CP | 14 | 14.7 | 150 | 87 | 161 | 5.3 | 0.78 | 1.4 | 230 | 4 | |
| YTX16-BS-1 | | CP | 14 | 14.7 | 150 | 87 | 161 | 5.3 | 0.78 | 1.4 | 230 | 1 | |
| YTX20-BS | | CP | 18 | 18.9 | 175 | 87 | 155 | 6.7 | 0.93 | 1.8 | 270 | 4 | |
| YTX20L-BS | | CP | 18 | 18.9 | 175 | 87 | 155 | 6.7 | 0.93 | 1.8 | 270 | 4 | |
| YT19BL-BS | | CP | 17.7 | 19 | 186 | 82 | 171 | 5.7 | 0.95 | 1.9 | 170 | 10 | |

(i) Includes 20mm spacer required when replacing YB16CL-B.

(ii) Includes 10mm spacer required when replacing YB14A-A1 and YB14A-A2.

(iii) Includes 17mm spacer to fit all BRP (Sea-Doo) 1500cc 4-stroke models year 2003 and up.

* CCA (Cold Cranking Amps) rating is for reference only. CCA is a theoretically calculated value.

Actual performance may vary due to test conditions.

DC = dry charged
(contains 1 battery, acid not included)
CP = combi pack
(contains 1 battery and 1 acid pack)
WC = wet charged
(contains 1 battery acid filled and charged)

| Battery Type | NOTE | Pack Type | Capacity Ah (10HR) | Capacity Ah (20HR) | Dimensions - mm (± 2 mm) | | | Weight with Acid (Kg) | Acid Volume (Litre) | Charge Current (Amps) | CCA* @ -18°C | Terminal Type (refer to page 10) | Assembly Figure |
|--------------------|------|-----------|--------------------|--------------------|-------------------------------|------|-----|-----------------------|---------------------|-----------------------|--------------|----------------------------------|-----------------|
| | | | | | L | W | H | | | | | | |
| YUMICRON CX | | | | | | | | | | | | | |
| YB16-B-CX | | DC | 19 | 20.0 | 175 | 100 | 155 | 6.3 | 1.2 | 1.9 | 255 | 6 | |
| YB16HL-A-CX | | DC | 19 | 20.0 | 175 | 100 | 155 | 6.3 | 1.2 | 1.9 | 255 | 6 | |
| Y50-N18L-A-CX | | DC | 20 | 21.1 | 205 | 90 | 162 | 7.4 | 1.4 | 2 | 260 | 7 | |
| YUMICRON | | | | | | | | | | | | | |
| YB2.5L-C | | DC | 2.5 | 2.6 | 81 | 71 | 106 | 1.0 | 0.25 | 0.3 | 15 | - | |
| YB2.5L-C-1 | | DC | 2.5 | 2.6 | 80 | 70 | 105 | 1.0 | 0.24 | 0.3 | 15 | - | |
| YB2.5L-C-2 | | DC | 2.5 | 2.6 | 81 | 71 | 106 | 1.0 | 0.24 | 0.3 | 15 | - | |
| YB3L-A | | DC | 3 | 3.2 | 99 | 57 | 111 | 1.3 | 0.3 | 0.3 | 30 | 6 | |
| YB3L-B | | DC/CP | 3 | 3.2 | 99 | 57 | 111 | 1.3 | 0.3 | 0.3 | 30 | 6 | |
| YB4L-A | | DC | 4 | 4.2 | 120 | 70 | 92 | 1.5 | 0.3 | 0.4 | 45 | 5 | |
| YB4L-B | | DC/CP | 4 | 4.2 | 121 | 71 | 93 | 1.5 | 0.3 | 0.4 | 45 | 5 | |
| YB5L-B | | DC/CP | 5 | 5.3 | 121 | 61 | 131 | 2.0 | 0.36 | 0.5 | 60 | 6 | |
| YB6L-B | | DC | 6 | 6.3 | 138 | 72.5 | 100 | 2.1 | 0.4 | 0.6 | 65 | 6 | |
| YB7-A | | DC/CP | 8 | 8.4 | 136 | 75 | 133 | 3.0 | 0.6 | 0.8 | 105 | 6 | |
| YB7B-B | | DC/CP | 7 | 7.4 | 152 | 61 | 132 | 3.1 | 0.5 | 0.7 | 80 | 6 | |
| YB7C-A | | DC/CP | 7 | 7.4 | 130 | 90 | 114 | 3.0 | 0.6 | 0.8 | 75 | 3 | |
| YB7L-B | | DC/CP | 8 | 8.4 | 135 | 75 | 133 | 2.9 | 0.6 | 0.8 | 75 | 6 | |
| YB7L-B2 | | DC | 8 | 8.4 | 135 | 75 | 133 | 2.9 | 0.6 | 0.8 | 75 | 4 | |
| YB9A-A | | DC | 9 | 9.5 | 135 | 75 | 155 | 3.1 | 0.6 | 0.9 | 115 | 6 | |
| YB9L-A2 | | DC/CP | 9 | 9.5 | 135 | 75 | 139 | 3.1 | 0.6 | 0.9 | 100 | 2 | |
| YB9-B | | DC/CP | 9 | 9.5 | 137 | 77 | 141 | 3.1 | 0.6 | 0.9 | 115 | 6 | |
| YB9L-B | | DC | 9 | 9.5 | 137 | 77 | 141 | 3.1 | 0.6 | 0.9 | 115 | 6 | |
| YB10A-A2 | | DC | 11 | 11.6 | 135 | 90 | 155 | 4.0 | 0.8 | 1.1 | 120 | 8 | |
| YB10L-A2 | | DC/CP | 11 | 11.6 | 135 | 90 | 145 | 4.2 | 0.8 | 1.1 | 120 | 8 | |
| YB10L-B | | DC/CP | 11 | 11.6 | 135 | 90 | 145 | 4.0 | 0.8 | 1.1 | 120 | 6 | |
| YB10L-BP | | DC | 12 | 12.6 | 135 | 90 | 145 | 4.0 | 0.8 | 1.1 | 165 | 6 | |
| YB10L-B2 | | DC | 11 | 11.6 | 135 | 90 | 145 | 4.0 | 0.8 | 1.1 | 120 | 8 | |
| YB12A-A | | DC/CP | 12 | 12.6 | 134 | 80 | 160 | 4.1 | 0.8 | 1.2 | 150 | 6 | |
| YB12A-AK | | DC | 10 | 10.5 | 134 | 80 | 160 | 3.5 | 0.8 | 1.0 | 165 | 6 | |
| YB12AL-A | | DC | 12 | 12.6 | 136 | 82 | 162 | 4.0 | 0.8 | 1.2 | 150 | 6 | |
| YB12AL-A2 | (i) | DC/CP | 12 | 12.6 | 134 | 80 | 160 | 4.0 | 0.75 | 1.2 | 150 | 8 | |
| YB12A-B | | DC/CP | 12 | 12.6 | 134 | 80 | 160 | 4.0 | 0.75 | 1.2 | 150 | 6 | |
| YB12B-B2 | | DC | 11 | 11.6 | 160 | 90 | 130 | 4.0 | 0.8 | 1.2 | 140 | 8 | |
| YB12C-A | | DC | 12 | 12.6 | 134 | 80 | 175 | 4.3 | 0.8 | 1.2 | 150 | 4 | |
| YB14-A2 | | DC/CP | 14 | 14.7 | 134 | 89 | 166 | 4.6 | 0.9 | 1.4 | 175 | 8 | |
| YB14-B2 | | DC/CP | 14 | 14.7 | 134 | 89 | 166 | 4.6 | 0.9 | 1.4 | 175 | 8 | |
| YB14A-A1 | | DC | 14 | 14.7 | 134 | 89 | 176 | 4.5 | 0.9 | 1.4 | 175 | 6 | |
| YB14A-A2 | | DC/CP | 14 | 14.7 | 134 | 89 | 176 | 4.5 | 0.9 | 1.4 | 175 | 8 | |
| YB14L-A | | DC | 14 | 14.7 | 134 | 89 | 166 | 4.6 | 0.9 | 1.4 | 190 | 6 | |
| YB14L-A1 | | DC | 14 | 14.7 | 134 | 89 | 166 | 4.6 | 0.9 | 1.4 | 175 | 1 | |
| YB14L-A2 | | DC/CP | 14 | 14.7 | 136 | 91 | 168 | 4.6 | 0.9 | 1.4 | 175 | 8 | |
| YB14L-B2 | | DC/CP | 14 | 14.7 | 136 | 91 | 168 | 4.6 | 0.9 | 1.4 | 175 | 8 | |
| SYB14L-A2 | | DC | 14 | 14.7 | 134 | 89 | 166 | 4.6 | 0.9 | 1.4 | 175 | 8 | |
| SYB14L-B2 | | DC | 14 | 14.7 | 134 | 89 | 166 | 4.6 | 0.9 | 1.4 | 175 | 8 | |
| YB16AL-A2 | | DC/CP | 16 | 16.8 | 207 | 71.5 | 164 | 5.3 | 1.1 | 1.6 | 210 | 2 | |
| HYB16A-AB | | DC | 16 | 16.8 | 151 | 91 | 180 | 5.0 | 0.9 | 1.6 | 190 | 7 | |

(i) Includes a terminal adaptor for converting to top mount.

* CCA (Cold Cranking Amps) rating is for reference only. CCA is a theoretically calculated value. Actual performance may vary due to test conditions.

DC = dry charged
(contains 1 battery, acid not included)
CP = combi pack
(contains 1 battery and 1 acid pack)
WC = wet charged
(contains 1 battery acid filled and charged)

Specifications

| Battery Type | NOTE | Pack Type | Capacity Ah (10HR) | Capacity Ah (20HR) | Dimensions - mm ($\pm 2\text{mm}$) | | | Weight with Acid (Kg) | Acid Volume (Litre) | Charge Current (Amps) | CCA* @ -18°C | Terminal Type (refer to page 10) | Assembly Figure |
|--------------|------|-----------|--------------------|--------------------|--------------------------------------|---|---|-----------------------|---------------------|-----------------------|--------------|----------------------------------|-----------------|
| | | | | | L | W | H | | | | | | |

YUMICRON continued

| | | | | | | | | | | | | | |
|--------------|-----|-------|----|------|-----|-----|-----|-----|-----|-----|-----|----|--|
| YB16-B | | DC/CP | 19 | 20.0 | 175 | 100 | 155 | 6.3 | 1.2 | 1.9 | 215 | 6 | |
| YB16L-B | | DC/CP | 19 | 20.0 | 175 | 100 | 155 | 6.3 | 1.2 | 1.9 | 215 | 6 | |
| YB16B-A | | DC | 16 | 16.8 | 160 | 90 | 161 | 5.1 | 1.0 | 1.6 | 207 | 4 | |
| YB16B-A1 | (i) | DC/CP | 16 | 16.8 | 160 | 90 | 161 | 5.1 | 1.0 | 1.6 | 207 | 7 | |
| YB16C-B | | DC | 19 | 20.0 | 175 | 100 | 175 | 6.1 | 1.2 | 1.9 | 240 | 5 | |
| YB16CL-B | | DC/CP | 19 | 20.0 | 175 | 100 | 175 | 6.1 | 1.2 | 1.9 | 240 | 5 | |
| YB18-A | | DC | 18 | 18.9 | 180 | 90 | 162 | 5.8 | 1.2 | 1.8 | 215 | 7 | |
| YB18L-A | | DC/CP | 18 | 18.9 | 180 | 90 | 162 | 5.8 | 1.2 | 1.8 | 215 | 7 | |
| Y50-N18A-A | | DC | 20 | 21.1 | 205 | 90 | 176 | 6.5 | 1.5 | 2.0 | 240 | 7 | |
| Y50-N18L-A | | DC | 20 | 21.1 | 205 | 90 | 162 | 7.4 | 1.4 | 2.0 | 240 | 7 | |
| Y50-N18L-A3 | | DC | 20 | 21.1 | 205 | 90 | 162 | 7.4 | 1.4 | 2.0 | 240 | 4 | |
| SY50-N18L-AT | | DC/CP | 20 | 21.1 | 205 | 90 | 162 | 6.5 | 1.4 | 2.0 | 240 | 7 | |
| Y60-N24-A | | DC | 28 | 29.5 | 184 | 124 | 175 | 8.6 | 1.7 | 2.8 | 241 | 3 | |
| Y60-N24L-A | | DC/CP | 28 | 29.5 | 184 | 124 | 175 | 8.6 | 1.7 | 2.8 | 241 | 3 | |
| YB30L-B | | DC | 30 | 31.6 | 168 | 132 | 176 | 8.5 | 1.7 | 3.0 | 300 | 4 | |
| YB30CL-B | | DC | 30 | 31.6 | 168 | 132 | 192 | 8.8 | 1.7 | 3.0 | 300 | 4 | |
| 51814 | ** | DC/CP | - | 18.0 | 186 | 82 | 171 | 5.6 | 1.0 | 1.9 | 100 | 10 | |
| 51913 | ** | DC/CP | - | 19.0 | 186 | 82 | 171 | 5.6 | 1.0 | 1.9 | 100 | 10 | |
| 52015 | ** | DC | - | 20.0 | 186 | 82 | 171 | 5.6 | 1.0 | 2.0 | 110 | 10 | |
| 52515 | ** | DC/CP | - | 25.0 | 186 | 130 | 171 | 8.4 | 1.8 | 2.5 | 130 | 10 | |
| 53030 | ** | DC/CP | - | 30.0 | 186 | 130 | 171 | 9.4 | 1.6 | 3.0 | 180 | 10 | |

CONVENTIONAL 12 Volt

| | | | | | | | | | | | | | |
|-------------|--|-------|-----|------|-----|-----|-----|-----|-----|-----|-----|---|--|
| 12N5-3B | | DC/CP | 5 | 5.3 | 120 | 60 | 130 | 2.0 | 0.4 | 0.5 | 35 | 6 | |
| 12N5-4B | | DC | 5 | 5.3 | 120 | 60 | 130 | 2.0 | 0.4 | 0.5 | 39 | 6 | |
| 12N5.5-3B | | DC/CP | 5.5 | 5.8 | 135 | 60 | 130 | 2.5 | 0.4 | 0.6 | 55 | 6 | |
| 12N5.5-4A | | DC | 5.5 | 5.8 | 135 | 60 | 130 | 2.5 | 0.4 | 0.6 | 55 | 2 | |
| 12N5.5-4B | | DC | 5.5 | 5.8 | 137 | 61 | 131 | 2.5 | 0.4 | 0.6 | 55 | 6 | |
| 12N5.5A-3B | | DC/CP | 5.5 | 5.8 | 103 | 90 | 114 | 2.4 | 0.5 | 0.6 | 55 | 6 | |
| 12N7-3B | | DC/CP | 7 | 7.4 | 135 | 75 | 133 | 3.0 | 0.5 | 0.7 | 70 | 6 | |
| 12N7-4A | | DC/CP | 7 | 7.4 | 135 | 75 | 133 | 3.0 | 0.5 | 0.7 | 70 | 6 | |
| 12N7-4B | | DC | 7 | 7.4 | 135 | 75 | 133 | 3.0 | 0.5 | 0.7 | 70 | 6 | |
| 12N7B-3A | | DC | 7 | 7.4 | 151 | 61 | 131 | 2.9 | 0.5 | 0.7 | 70 | 6 | |
| 12N7D-3B | | DC | 7 | 7.4 | 135 | 75 | 150 | 2.9 | 0.6 | 0.7 | 70 | 6 | |
| 12N9-3A | | DC | 9 | 9.5 | 135 | 75 | 139 | 3.3 | 0.6 | 0.9 | 80 | 9 | |
| 12N9-3B | | DC/CP | 9 | 9.5 | 135 | 75 | 139 | 3.2 | 0.6 | 0.9 | 85 | 6 | |
| 12N9-4B-1 | | DC/CP | 9 | 9.5 | 135 | 75 | 139 | 3.2 | 0.6 | 0.9 | 85 | 6 | |
| 12N10-3A | | DC/CP | 10 | 10.5 | 135 | 90 | 145 | 3.9 | 0.8 | 1.0 | 100 | 6 | |
| 12N10-3A-1 | | DC | 10 | 10.5 | 135 | 90 | 145 | 3.9 | 0.8 | 1.0 | 100 | 6 | |
| 12N10-3A-2 | | DC | 10 | 10.5 | 135 | 90 | 145 | 3.9 | 0.8 | 1.0 | 100 | 8 | |
| 12N10-3B | | DC/CP | 10 | 10.5 | 136 | 92 | 146 | 3.9 | 0.8 | 1.0 | 100 | 6 | |
| 12N11-3A-1 | | DC | 11 | 11.6 | 135 | 90 | 155 | 3.6 | 0.8 | 1.1 | 109 | 8 | |
| 12N11-3B | | DC | 11 | 11.6 | 135 | 90 | 155 | 3.6 | 0.8 | 1.1 | 109 | 6 | |
| 12N12-3B | | DC | 12 | 12.6 | 202 | 76 | 134 | 4.4 | 0.8 | 1.2 | 108 | 6 | |
| 12N12A-4A-1 | | DC/CP | 12 | 12.6 | 134 | 80 | 160 | 3.7 | 0.7 | 1.2 | 120 | 6 | |
| 12N14-3A | | DC/CP | 14 | 14.7 | 134 | 89 | 166 | 4.5 | 0.8 | 1.4 | 125 | 8 | |
| 12N18-3 | | DC | 18 | 18.9 | 205 | 90 | 162 | 6.5 | 1.3 | 1.8 | 140 | 6 | |
| 12N24-3A | | DC | 24 | 25.3 | 184 | 124 | 175 | 7.9 | 1.8 | 2.4 | 200 | 3 | |
| 12N24-3 | | DC | 24 | 25.3 | 184 | 124 | 175 | 7.9 | 1.8 | 2.4 | 200 | 3 | |
| 12N24-4 | | DC/CP | 24 | 25.3 | 184 | 124 | 179 | 7.6 | 1.6 | 2.4 | 190 | 3 | |
| YHD-12 | | DC | 29 | 29.5 | 206 | 133 | 165 | 8.3 | 2.2 | 2.8 | 200 | 9 | |

(i) Includes terminal adator for converting to side mount

* CCA (Cold Cranking Amps) rating is for reference only. CCA is a theoretically calculated value. Actual performance may vary due to test conditions.

** CCA values as mentioned are based on the DIN standard and are for reference only.

DC = dry charged
(contains 1 battery, acid not included)
CP = combi pack
(contains 1 battery and 1 acid pack)
WC = wet charged
(contains 1 battery acid filled and charged)

| Battery Type | NOTE | Pack Type | Capacity Ah (10HR) | Capacity Ah (20HR) | Dimensions - mm (± 2 mm) | | | Weight with Acid (Kg) | Acid Volume (Litre) | Charge Current (Amps) | CCA* @ -18°C | Terminal Type (refer to page 10) | Assembly Figure |
|--------------|------|-----------|--------------------|--------------------|-------------------------------|----|-----|-----------------------|---------------------|-----------------------|--------------|----------------------------------|-----------------|
| | | | | | L | W | H | | | | | | |
| 6N2-2A | | DC | 2 | 2.1 | 70 | 47 | 96 | 0.5 | 0.1 | 0.2 | | - | |
| 6N2-2A-1 | | DC | 2 | 2.1 | 70 | 47 | 96 | 0.5 | 0.1 | 0.2 | | - | |
| 6N2-2A-3 | | DC | 2 | 2.1 | 70 | 47 | 96 | 0.5 | 0.1 | 0.2 | | - | |
| 6N2-2A-4 | | DC | 2 | 2.1 | 70 | 47 | 96 | 0.5 | 0.1 | 0.2 | | - | |
| 6N2-2A-8 | | DC | 2 | 2.1 | 70 | 47 | 96 | 0.5 | 0.1 | 0.2 | | - | |
| 6N2-2A-9 | | DC | 2 | 2.1 | 70 | 47 | 96 | 0.5 | 0.1 | 0.2 | | - | |
| 6N2A-2C | | DC | 2 | 2.1 | 70 | 47 | 106 | 0.5 | 0.1 | 0.2 | | - | |
| 6N2A-2C-1 | | DC | 2 | 2.1 | 70 | 47 | 106 | 0.5 | 0.1 | 0.2 | | - | |
| 6N2A-2C-3 | | DC | 2 | 2.1 | 70 | 47 | 106 | 0.5 | 0.1 | 0.2 | | - | |
| 6N2A-2C-4 | | DC | 2 | 2.1 | 70 | 47 | 106 | 0.5 | 0.1 | 0.2 | | - | |
| 6N4-2A | | DC | 4 | 4.2 | 71 | 71 | 96 | 0.8 | 0.2 | 0.4 | | - | |
| 6N4-2A-2 | | DC | 4 | 4.2 | 71 | 71 | 96 | 0.8 | 0.2 | 0.4 | | - | |
| 6N4-2A-3 | | DC | 4 | 4.2 | 71 | 71 | 96 | 0.8 | 0.2 | 0.4 | | - | |
| 6N4-2A-4 | | DC | 4 | 4.2 | 71 | 71 | 96 | 0.8 | 0.2 | 0.4 | | - | |
| 6N4-2A-5 | | DC | 4 | 4.2 | 71 | 71 | 96 | 0.8 | 0.2 | 0.4 | | - | |
| 6N4-2A-7 | | DC | 4 | 4.2 | 71 | 71 | 96 | 0.8 | 0.2 | 0.4 | | - | |
| 6N4-2A-8 | | DC | 4 | 4.2 | 71 | 71 | 96 | 0.8 | 0.2 | 0.4 | | - | |
| 6N4-2A-9 | | DC | 4 | 4.2 | 71 | 71 | 96 | 0.8 | 0.2 | 0.4 | | - | |
| 6N4-2A-12 | | DC | 4 | 4.2 | 71 | 71 | 96 | 0.8 | 0.2 | 0.4 | | - | |
| 6N4A-4D | | DC | 4 | 4.2 | 61 | 57 | 131 | 1.0 | 0.2 | 0.4 | | - | |
| 6N4B-2A | | DC | 4 | 4.2 | 102 | 48 | 96 | 1.0 | 0.2 | 0.4 | | - | |
| 6N4B-2A-3 | | DC | 4 | 4.2 | 102 | 48 | 96 | 1.0 | 0.2 | 0.4 | | - | |
| 6N4B-2A-4 | | DC | 4 | 4.2 | 102 | 48 | 96 | 1.0 | 0.2 | 0.4 | | - | |
| 6N4B-2A-5 | | DC | 4 | 4.2 | 102 | 48 | 96 | 1.0 | 0.2 | 0.4 | | - | |
| 6N4C-1B | | DC | 4 | 4.2 | 71 | 71 | 105 | 0.8 | 0.2 | 0.4 | | - | |
| 6N5.5-1D | | DC | 5.5 | 5.8 | 90 | 70 | 100 | 1.1 | 0.3 | 0.6 | | - | |
| 6N6-1B | | DC | 6 | 6.3 | 99 | 57 | 111 | 1.2 | 0.3 | 0.6 | | - | |
| 6N6-3B | | DC | 6 | 6.3 | 99 | 57 | 111 | 1.3 | 0.3 | 0.6 | | 6 | |
| 6N6-3B-1 | | DC/CP | 6 | 6.3 | 99 | 57 | 111 | 1.3 | 0.3 | 0.6 | | 6 | |
| 6N6-1D | | DC | 6 | 6.3 | 99 | 57 | 111 | 1.2 | 0.3 | 0.6 | | - | |
| 6N6-1D-2 | | DC | 6 | 6.3 | 99 | 57 | 111 | 1.2 | 0.3 | 0.6 | | - | |
| B39-6 | | DC | 7 | 7.4 | 126 | 48 | 126 | 1.7 | 0.3 | 0.7 | | 6 | |
| B49-6 | | DC/CP | 8 | 8.4 | 91 | 83 | 161 | 2.1 | 0.5 | 0.8 | | 6 | |
| 6N11-2D | | DC | 11 | 11.6 | 150 | 70 | 100 | 2.0 | 0.4 | 1.1 | | 6 | |
| 6N11A-1B | | DC | 11 | 11.6 | 122 | 62 | 131 | 2.1 | 0.4 | 1.1 | | 6 | |
| 6N11A-3A | | DC/CP | 11 | 11.6 | 122 | 62 | 131 | 2.1 | 0.4 | 1.1 | | 6 | |
| 6N11A-4 | | DC | 11 | 11.6 | 122 | 62 | 131 | 2.1 | 0.4 | 1.1 | | 6 | |
| 6N12A-2C | | DC | 12 | 12.6 | 156 | 57 | 116 | 2.0 | 0.5 | 1.2 | | 9 | |
| B54-6 | | DC | 12 | 12.6 | 156 | 57 | 116 | 2.3 | 0.5 | 1.2 | | 6 | |
| 6N12A-2D | | DC | 12 | 12.6 | 156 | 57 | 116 | 2.3 | 0.45 | 1.2 | | 6 | |
| B38-6A | | DC | 13 | 13.7 | 119 | 83 | 161 | 2.9 | 0.62 | 1.3 | | 6 | |
| 6YB8L-B | | DC | 8 | 8.4 | 120 | 70 | 95 | 1.6 | 0.31 | 0.8 | | 6 | |
| 6YB11-2D | | DC | 11 | 11.6 | 150 | 70 | 100 | 2.0 | 0.4 | 1.1 | | 6 | |

* CCA (Cold Cranking Amps) rating is for reference only. CCA is a theoretically calculated value. Actual performance may vary due to test conditions.

DC = dry charged
(contains 1 battery, acid not included)
CP = combi pack
(contains 1 battery and 1 acid pack)
WC = wet charged
(contains 1 battery acid filled and charged)

Terminal Configurations

Terminal shapes vary from one battery to another. By identifying the correct replacement battery from the listing in this book, you are assured of the proper terminal configuration. For custom applications, refer to the following chart to identify terminal shape and corresponding batteries.

| Type | Terminal Shape | | | Battery Type | | | | |
|------|----------------|------|-----|---|---|---|---|---|
| | Front | Side | Top | | | | | |
| 1 | | | | YB14L-A1 | YTX16-BS-1 | | | |
| 2 | | | | YB9L-A2 | YB16AL-A2 | 12N5.5-4A | | |
| 3 | | | | Y60-N24-A | 12N24-3 | 12N24-3A | YB7C-A | 12N24-4 |
| 4 | | | | YB12C-A YTX14AH-BS YTX20-BS YTX24HL-BS | YB16B-A YTX14AHL-BS YTX20L-BS GYZ20L | Y50-N18L-A3 YTX14H-BS YTX20H-BS YTX16-BS | YB30L-B YTX15L-BS YTX20HL-BS | YB30CL-B YTX20CH-BS YTX20HL-BS-PW |
| 5 | | | | YTZ3 YTZ7V YTX7L-BS YTX14L-BS YB16C-B | YTZ4V YTZ8V YTX9-BS YB16CL-B | YTZ5S YTX4L-BS YT12A-BS YIX30L GYZ16HL | YTZ6 YTX5L-BS YTX12-BS YB4L-A | YTZ7S YTX7A-BS YTX14-BS YB4L-B |
| 6 | | | | YB3L-A YB7B-B YB10L-B YB14A-A1 YB16HL-A-CX 12N5.5-4B 12N9-3B 12N18-3 6N11-2D B39-6 | YB3L-B YB7L-B YB10L-BP YB14L-A 12N5-3B 12N7-3B 12N9-4B-1 6N6-3B 6N12A-2D B49-6 | YB5L-B YB9A-A YB12A-A YB16-B 12N5-4B 12N7-4A 12N10-3B 6N6-3B-1 6YB8L-B B54-6 | YB6L-B YB9-B YB12A-B YB16-B-CX 12N5.5-3B 12N7-4B 12N10-3B-A 6N11A-1B 6YB11-2D | YB7-A YB9L-B YB12AL-A YB16L-B 12N5.5A-3B 12N7D-3B 12N12A-4A-1 6N11A-3A B38-6A |
| 7 | | | | HYB16A-AB Y50-N18L-A | YB16B-A1** Y50-N18L-A2 | YB18-A Y50-N18L-A-CX | YB18L-A SY50-N18L-A | Y50-N18A-A SY50-N18L-AT |
| 8 | | | | YB10A-A2 YB14-A2 YB14-B2 | YB10L-A2 YB14A-A2 YB14L-B2 | YB10L-B2 YB14L-A2 12N10-3A-2 | YB12AL-A2* SYB14L-A2 12N11-3A-1 | YB12B-B2 SYB14L-B2 12N14-3A |
| 9 | | | | YHD-12 | 6N12A-2C | 12N9-3A | | |
| 10 | | | | 51814 | 52015 | 51913 | 52515 | 53030 |
| 11 | | | | YT7B-BS YTZ12S | YT9B-BS YTZ14S | YT12B-BS | YT14B-BS | YTZ10S |
| 12 | | | | YTR4A-BS | | | | |
| 13 | | | | YT4B-BS | | | | |
| 14 | | | | GYZ20H | GYZ20HL | GYZ32HL | | |

* Includes terminal adaptor for converting to top mount. ** Includes terminal adaptor for converting to side mount.

Battery Upgrade Cross Reference Chart

| GYZ Series | AGM High Performance | AGM Maintenance Free | YuMicron (CX) | Conventional |
|-------------------------------|----------------------------|------------------------|---------------------------|--------------|
| - | - | - | 6YB11-2D | 6N11-2D |
| - | YTZ5S | YTX4L-BS, YT4L-BS | YB4L-A, YB4L-B | - |
| - | YTZ7S | YTX5L-BS, YT5L-BS | - | - |
| - | - | - | YB5L-B | 12N5-3B |
| - | - | - | YB7L-B | 12N7-3B |
| - | - | - | YB7-B | 12N7-4A |
| - | - | - | YB9-B | 12N9-4B-1 |
| - | - | - | YB9L-B | 12N9-3B |
| - | - | - | YB10L-A2 | 12N10-3A-2 |
| - | - | - | YB12-A | 12N12A-4A-1 |
| GYZ16H | YTX14H-BS | YTX14-BS | - | - |
| - | YTX14AH-BS | - | YB14-A2, YB14-B2 | - |
| - | YTX14AH-BS ¹ | - | YB14A-A1, YB14A-A2 | - |
| - | YTX14AHL-BS | - | YB14L-A2 | 12N14-3A |
| - | YTX14AHL-BS | - | YB14L-B2 | - |
| GYZ16HL | YTX14L-BS | - | - | - |
| - | - | YT19BL-BS | 51913 | - |
| - | YTX20CH-BS | YTX16-BS | - | - |
| GYZ20H ² | YTX20H-BS ³ | YTX20-BS ³ | YB16-B, YB16-B-CX | - |
| GYZ20H | YTX20H-BS ³ | YTX20-BS ³ | YB18-A | - |
| - | YTX20HL-BS PW ⁴ | - | YB16CL-B | - |
| GYZ20HL ⁵ , GYZ20L | YTX20HL-BS ³ | YTX20L-BS ³ | YB16HL-A-CX | - |
| GYZ20HL, GYZ20L | YTX20HL-BS ³ | YTX20L-BS ³ | YB16L-B | - |
| GYZ20HL ⁶ , GYZ20L | YTX20HL-BS ³ | YTX20L-BS ³ | YB18L-A | - |
| GYZ20HL ⁷ , GYZ20L | YTX20HL-BS ³ | YTX20L-BS | - | - |
| - | YTX24HL-BS ³ | - | Y50-N18L-A, Y50-N18L-A-CX | - |
| - | YTX24HL-BS | - | Y50-N18-A3 | - |
| - | YTX24HL-BS ⁸ | - | SY50-N18-AT | - |
| GYZ32HL | YIX30L-BS | - | YB30L-B | - |
| - | YIX30L-BS-PW ⁴ | - | YB30CLB | - |
| - | YIX30L-BS | - | 53030 | - |

- 1 Eliminates need for sensor (needs to be disabled).
- 2 The YTX20 series batteries may be used as an optional upgrade, but some modification to the hold down may be necessary. See battery label for retrofit cautions.
- 3 Top and front terminal mounts only.

- 4 Includes 10mm height spacer.
- 5 Includes 17mm height spacer.
- 6 Includes 20mm height spacer for use in replacing YB16CL-B.
- 7 Requires use of Yuasa Cover/Spacer Kit.
- 8 For Harley-Davidson models only.

Designation of Battery Type Numbers

Examples:

6 | N | 2 | | - | 2 | A | - | 8
 | | | | | | | | | | | | | | | | | | | | | |
 12 | N | 12 | A | - | 4 | A | - | 1
 a | b | c | d | | e | f | | g

YB | 16 | A | L | - | A | 2
 | | | | | | | | | | | | | | | | | | | | | |
 h | j | d | e | | f | g

Y | 50 | - | N | 18 | L | - | A
 | | | | | | | | | | | | | | | | | | | | | |
 h | j | | b | i | e | | f

YT | X | 20 | H | L | - | B | S
 | | | | | | | | | | | | | | | | | | | | | |
 k | m | i | m | e | | | l

YT | X | 7 | L | - | B | S
 | | | | | | | | | | | | | | | | | | | | | |
 k | m | i | e | | | l

Designations:

- a - nominal voltage
- b - vented type (normal type)
- c - battery capacity at 10 hour rate
- d - indication of different size of the same capacity batteries
- e - polarity location (see Fig. 1), configuration
- f - location of opening for exhaust (see Fig. 2)
- g - type of terminal
- h - symbol of YuMicron batteries
- i - performance level
- j - cranking or starting power
- k - symbol of Yuasa maintenance free (VRLA) batteries (YT, YI)
- l - bottle supplied electrolyte
- m - high performance

Fig. 1 e Polarity Location (L indicates positive terminal is located at right side.)

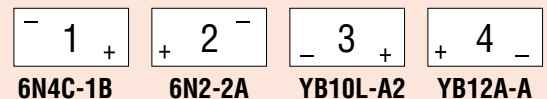
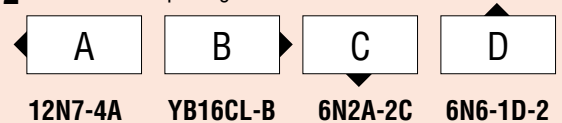

Fig. 2 f Location of opening for exhaust



Can't find your vehicle listed?
 Visit www.yuasa.com for our latest application data

Maximum Power

Minimum Space



The Yuasa YTZ® battery is the only powersports battery in the world to incorporate expanded plate technology. Approved by the world's leading Original Equipment Manufacturers, they are designed to deliver exactly what powersports enthusiasts really need:

- **Enhanced Starting Power**
- **Longer Battery Life**
- **Superior Reliability**
- **Maximum Performance**

Because they are small, light and more volume efficient, Yuasa YTZ® batteries provide greater starting power from minimum space. Factory sealed and activated, they are completely spill proof enabling multi-angle fitment, never require refilling and are maintenance free during the complete lifetime of the battery.

Heat Sealed Case to Cover

Protects against leakage and corrosion and provides for extra strength and durability.

Special Active Material

Compounded to withstand vibration, it prolongs the battery life in storage and provides reliable starting power when needed.

Unique Expanded Plate Grid Design

Increased number of plates for maximum starting power and to withstand severe vibration resistance.

AGM Separators

Absorbed Glass Matt separators absorb the electrolyte and make the battery spill proof. The valve regulated design eliminates water loss and the need for refilling.

Polypropylene (PP) Cover & Container

Protects against fuel and oil and designed to withstand vibration and impact under extreme conditions.

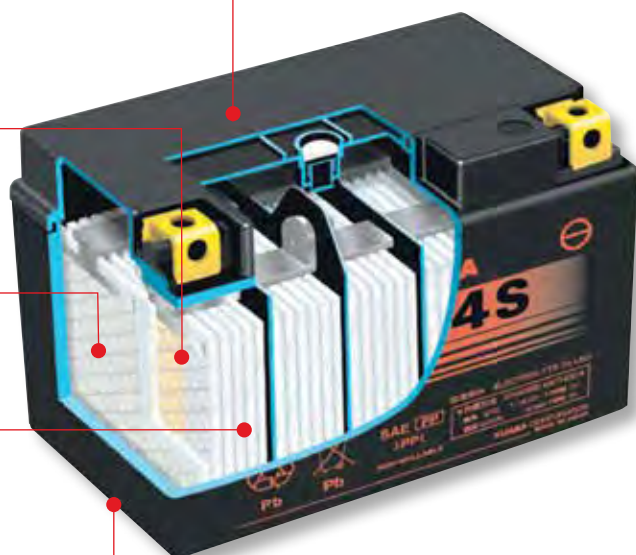



| Battery Type | Pack Type | Capacity Ah (10HR) | Capacity Ah (20HR) | Dimensions - mm (± 2mm) | | | Weight with Acid (Kg) | Acid Volume (Litre) | Charge Current (Amps) | CCA* @ -18°C | Terminal Type (refer to page 10) | Assembly Figure |
|--------------|-----------|--------------------|--------------------|-------------------------|----|-----|-----------------------|---------------------|-----------------------|--------------|----------------------------------|-----------------|
| | | | | L | W | H | | | | | | |
| YTZ7S | WC | 6 | 6.3 | 113 | 70 | 105 | 2.1 | N/A | 0.6 | 130 | 5 | |
| YTZ10S | WC | 8.6 | 9.1 | 150 | 87 | 93 | 3.2 | N/A | 0.9 | 190 | 11 | |
| YTZ12S | WC | 11 | 11.6 | 150 | 87 | 110 | 3.7 | N/A | 1.1 | 210 | 11 | |
| YTZ14S | WC | 11.2 | 11.8 | 150 | 87 | 110 | 3.9 | N/A | 1.1 | 230 | 11 | |

YTZ[®] Mounting Angle

Because of their unique spill proof design, Yuasa YTZ batteries can be installed under multiple mounting angles as explained below.

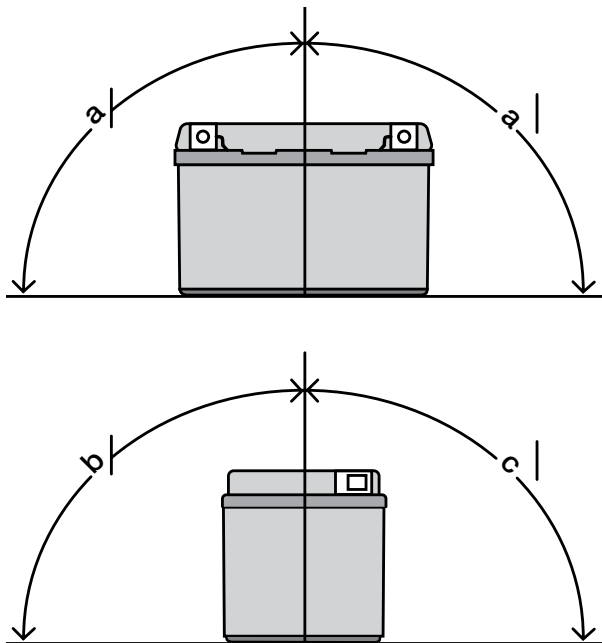

| YTZ [®] series | Mounting Angle | | |
|-------------------------|----------------|----|----|
| | a° | b° | c° |
| YTZ7S | 40 | 90 | 15 |
| YTZ10S | 40 | 90 | 15 |
| YTZ12S | 40 | 90 | 15 |
| YTZ14S | 40 | 90 | 15 |

TTZ Mounting Angle

TTZ batteries cannot be installed under the same angle as YTZ batteries. The mounting angles for TTZ batteries are limited to the below angles.

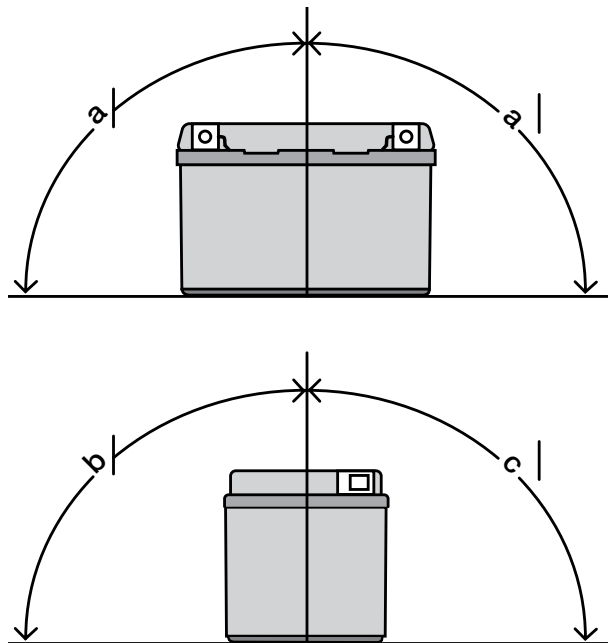

| TTZ series | Mounting Angle | | |
|---------------|----------------|----|----|
| | a° | b° | c° |
| TTZ7S | 30 | 20 | 20 |
| TTZ10S | 30 | 20 | 20 |
| TTZ12S | 30 | 20 | 20 |
| TTZ14S | 30 | 20 | 20 |

Notes:

- The above mentioned angles show the allowance from the centre position of the battery.
- The above mentioned angles are evaluated by up & down single vibration only.
- WC = wet charged (contains 1 battery acid filled and charged).

Cross Reference

Yuasa

GS

High Performance AGM

| | |
|-------------|------------|
| YTX14AH-BS | GTX14A-BS |
| YTX14AHL-BS | GTX14AL-BS |
| YTX14H-BS | GTX14H-BS |
| YTX20CH-BS | GTX20CH-BS |
| YTX20H-BS | GTX20H-BS |
| YTX20HL-BS | GTX20HL-BS |
| YTX24HL-BS | GTX24HL-BS |
| YIX30L-BS | GTX30L-BS |
| YTZ7S | YTZ7S |
| YTZ10S | YTZ10S |
| YTZ12S | YTZ12S |
| YTZ14S | YTZ14S |

Maintenance free AGM

| | |
|------------|------------|
| YT4B-BS | GT4B-BS |
| YTR4A-BS | GTR4A-BS |
| YTX4L-BS | GTX4L-BS |
| YTX5L-BS | GTX5L-BS |
| YT7B-BS | GT7B-BS |
| YTX7A-BS | GTX7A-BS |
| YTX7L-BS | GTX7L-BS |
| YT9B-BS | GT9B-BS |
| YTX9-BS | GTX9-BS |
| YT12A-BS | GT12A-BS |
| YT12B-BS | GT12B-BS |
| YTX12-BS | GTX12-BS |
| YT14B-BS | GT14B-BS |
| YTX14-BS | GTX14-BS |
| YTX14L-BS | GTX14L-BS |
| YTX16-BS | GTX16-BS |
| YTX16-BS-1 | GTX16-BS-1 |
| YT19BL-BS | GT19BL-BS |
| YTX20-BS | GTX20-BS |
| YTX20L-BS | GTX20L-BS |

Yumicron CX

| | |
|-------------|----------|
| YB16-B-CX | GT16-BS |
| YB16HL-A-CX | GT16L-BS |

Yumicron

| | |
|------------|------------|
| YB2.5L-C | CB2.5L-C |
| YB2.5L-C-1 | CB2.5L-C-1 |
| YB2.5L-C-2 | CB2.5L-C-2 |
| YB3L-A | CB3L-A |
| YB3L-B | CB3L-B |
| YB4L-A | CB4L-A |
| YB4L-B | CB4L-B |
| YB5L-B | CB5L-B |
| YB7-A | CB7-A |
| YB7C-A | CB7C-A |
| YB7L-B | CB7L-B |
| YB7L-B2 | CB7L-B2 |

Yuasa

GS

Yumicron continued

| | |
|--------------|--------------|
| YB9-B | CB9-B |
| YB9A-A | CB9A-A |
| YB9L-A2 | CB9L-A2 |
| YB9L-B | CB9L-B |
| YB10A-A2 | CB10A-A2 |
| YB10L-A2 | CB10L-A2 |
| YB10L-B | CB10L-B |
| YB10L-B2 | CB10L-B2 |
| YB10L-BP | CB10L-BP |
| YB12A-A | CB12A-A |
| YB12A-B | CB12A-B |
| YB12AL-A | CB12AL-A |
| YB12AL-A2 | CB12AL-A2 |
| YB12B-B2 | CB12B-B2 |
| YB12C-A | CB12C-A |
| YB14-A2 | CB14-A2 |
| YB14-B2 | CB14-B2 |
| YB14A-A1 | CB14A-A1 |
| YB14A-A2 | CB14A-A2 |
| YB14L-A1 | CB14L-A1 |
| YB14L-A2 | CB14L-A2 |
| YB14L-B2 | CB14L-B2 |
| SYB14L-A2 | SCB14L-A2 |
| SYB14L-B2 | SCB14L-B2 |
| YB16-B | CB16-B |
| YB16B-A | CB16B-A |
| YB16AL-A2 | CB16AL-A2 |
| YB16CL-B | CB16CL-B |
| YB16L-B | CB16L-B |
| HYB16A-AB | HCB16A-A |
| YB18-A | CB18-A |
| YB18L-A | CB18L-A |
| Y50-N18L-A | C50-N18L-A |
| Y50-N18L-A2 | C50-N18L-A2 |
| Y50-N18L-A3 | C50-N18L-A3 |
| SY50-N18L-AT | SC50-N18L-AT |
| Y60-N24-A | C60-N24-A |
| Y60-N24L-A | C60-N24L-A |
| 51814 | 51814 |
| 51913 | 51913 |
| 52015 | 52015 |
| 52515 | 52515 |
| 53030 | 53030 |

Conventional 12 Volt

| | |
|-----------|-----------|
| 12N5-3B | 12N5-3B |
| 12N5-4B | 12N5-4B |
| 12N5.5-3B | 12N5.5-3B |
| 12N5.5-4A | 12N5.5-4A |
| 12N5.5-4B | 12N5.5-4B |



Acid bottles

Yuasa

GS

Conventional 12 Volt continued

| | |
|-------------|-------------|
| 12N5.5A-3B | 12N5.5A-3B |
| 12N7-3B | 12N7-3B |
| 12N7-4A | 12N7-4A |
| 12N7-4B | 12N7-4B |
| 12N7D-3B | 12N7D-3B |
| 12N9-3A | 12N9-3A |
| 12N9-3B | 12N9-3B |
| 12N9-4B-1 | 12N9-4B-1 |
| 12N10-3B | 12N10-3B |
| 12N11-3A-1 | 12N11-3A-1 |
| 12N11-3B | 12N11-3B |
| 12N12A-4A-1 | 12N12A-4A-1 |
| 12N14-3A | 12N14-3A |
| 12N18-3 | 12N18-3 |
| 12N24-3A | 12N24-3A |
| YHD-12H | CHD4-12 |

Conventional 6 Volt

| | |
|-----------|-----------|
| 6N2-2A | 6N2-2A |
| 6N2-2A-3 | 6N2-2A-3 |
| 6N2-2A-4 | 6N2-2A-4 |
| 6N2-2A-8 | 6N2-2A-8 |
| 6N2A-2C | 6N2A-2C |
| 6N2A-2C-3 | 6N2A-2C-3 |
| 6N4-2A | 6N4-2A |
| 6N4-2A-2 | 6N4-2A-2 |
| 6N4-2A-3 | 6N4-2A-3 |
| 6N4-2A-4 | 6N4-2A-4 |
| 6N4-2A-5 | 6N4-2A-5 |
| 6N4-2A-7 | 6N4-2A-7 |
| 6N4-2A-8 | 6N4-2A-8 |
| 6N4A-4D | 6N4A-4D |
| 6N4B-2A | 6N4B-2A |
| 6N4B-2A-3 | 6N4B-2A-3 |
| 6N4B-2A-4 | 6N4B-2A-4 |
| 6N4B-2A-5 | 6N4B-2A-5 |
| 6N-4C-1B | 6N-4C-1B |
| 6N5.5-1D | 6N5.5-1D |
| 6N6-1D-2 | 6N6-1D-2 |
| 6N6-3B | 6N6-3B |
| 6N6-3B-1 | 6N6-3B-1 |
| 6N11-2D | 6N11-2D |
| 6N11A-1B | 6N11A-1B |
| 6N11A-3A | 6N11A-3A |
| 6N11A-4A | 6N11A-4A |
| 6N12A-2C | 6N12A-2C |
| 6N12A-2D | 6N12A-2D |
| B38-6A | B38-6A |
| B39-6 | B39-6 |
| B49-6 | B49-6 |



Battery Model

Acid bottle

| | |
|---------------|------------|
| YT7B-BS | ECTC-0.30 |
| YTX7A-BS | ECTC-0.33 |
| YTX7L-BS | ECTCA-0.33 |
| YT9B-BS | ECTC-0.40 |
| YTX9-BS | ECTC-0.40 |
| YTX12-BS | ECTC-0.60 |
| YT12A-BS | ECTC-0.49 |
| YT12B-BS | ECTC-0.52 |
| YT14B-BS | ECTCA-0.60 |
| YTX14-BS | ECTC-0.69 |
| YTX16-BS | ECTC-0.78 |
| YTX16-BS-1 | ECTC-0.78 |
| YTX20-BS | ECTC-0.93 |
| YTX20L-BS | ECTC-0.93 |
| TTZ10S | ECTC-0.40 |
| TTZ12S | ECTC-0.52 |
| TTZ14S | ECTC-0.52 |
| YIX30L-BS | 479632 |
| YTX14AH-BS | 5YHP14ACD |
| YTX14AHL-BS | 5YHP14ACD |
| YTX14H-BS | 5YT14ACDP |
| YTX14L-BS | 5YT14ACDP |
| YTX15L-BS | 5YT15ACDP |
| YTX20CH-BS | 5YT20CACDP |
| YTX20H-BS | 5YT20AHAD |
| YTX20HL-BS | 5YT20AHAD |
| YTX20HL-BS-PW | 5YT20AHAD |
| YTX24HL-BS | 478016 |
| YTX4L-BS | ECR-0.18 E |
| YTX5L-BS | ECR-0.24 E |
| YTZ5S | ECR-0.20 E |
| YTZ6V | ECR-0.27 E |

Can't find your vehicle listed?
Visit www.yuasa.com for our latest application data

| CC | Model | Year | High Performance Maintenance Free | Maintenance Free VRLA | YuMicron | Conventional |
|------------------|----------------------|-------|-----------------------------------|-----------------------|----------|--------------|
| AERMACCHI | | | | | | |
| 125 | SX | - | - | - | - | 12N7-3B |
| 175 | SX | - | - | - | - | 12N7-3B |
| 250 | Ala Azzurra/Bianca | - | - | - | - | 6N11A-1B |
| 250 | Ala Oro/Rossa/Verde | - | - | - | - | 6N11A-1B |
| 250 | Chimera | - | - | - | - | B39-6 |
| 250 | SX | - | - | - | - | 12N7-3B |
| 350 | Ala Azzurra/Bianca | - | - | - | - | 6N11A-1B |
| 350 | Ala Oro/Rossa/Verde | - | - | - | - | 6N11A-1B |
| APRILIA | | | | | | |
| 50 | AF-1 Futura/Europa | 87-94 | - | - | YB4L-B | - |
| 50 | Amico GL/LK/LX/Sport | 92-97 | - | - | YB4L-B | - |
| 50 | AREA 51 | 00 | - | - | YB4L-B | - |
| 50 | Classic 50 | -97 | - | - | YB4L-B | - |
| 50 | ET | - | - | - | YB4L-B | - |
| 50 | Gulliver AC/LC | -97 | - | - | YB4L-B | - |
| 50 | H2O | 00- | - | - | YB4L-B | - |
| 50 | Habana, Custom | 99 | - | - | YB4L-B | - |
| 50 | LC | - | - | - | YB4L-B | - |
| 50 | Mc Gulliver | 00 | - | - | YB4L-B | - |
| 50 | Mojito | - | - | - | YB4L-B | - |
| 50 | Mojito 25 KM/H FL | - | - | - | YB4L-B | - |
| 50 | Mojito FL | - | - | - | YB4L-B | - |
| 50 | MX50 | - | - | - | YB4L-B | - |
| 50 | Pegaso | 00- | - | - | YB4L-B | - |
| 50 | Rally | 04-05 | - | - | YB4L-B | - |
| 50 | Rally AC/LC | -97 | - | - | YB4L-B | - |
| 50 | Red Rose/Classic | -97 | - | - | YB4L-B | - |
| 50 | Replica | 00- | - | - | YB4L-B | - |
| 50 | RS50 | 00-05 | - | - | YB4L-B | - |
| 50 | RS50/Extrema | -97 | - | - | YB4L-B | - |
| 50 | RX-50 | -93 | - | - | YB4L-B | - |
| 50 | Scarabeo 2T | 97- | - | - | YB4L-B | - |
| 50 | Scarabeo 4T | 03- | - | - | YB9-B | - |
| 50 | Scarabeo 50 | 00-03 | - | - | YB4L-B | - |
| 50 | Scarabeo 50 Street | 13- | - | - | YB4L-B | - |
| 50 | Scarabeo eu | - | - | - | YB9-B | - |
| 50 | Scarabeo Diech | 02- | - | YTX5L-BS | - | - |
| 50 | Sonic | 00- | - | - | YB4L-B | - |
| 50 | Sonic, GP | 99 | - | - | YB4L-B | - |
| 50 | Sonic Acqua | - | - | - | YB4L-B | - |
| 50 | SR CARB | 08 | - | - | YB9-B | - |
| 50 | SR Ditech | 01- | - | YTX5L-BS | - | - |
| 50 | SR IE | 08 | - | - | YB9-B | - |
| 50 | SR IE 25 KM/H | - | - | - | YB9-B | - |
| 50 | SR IE CND | - | - | - | YB9-B | - |
| 50 | SR IE USA | - | - | - | YB9-B | - |
| 50 | SR LC/Netscaper | -97 | - | - | YB4L-B | - |
| 50 | SR Netscaper | 00- | - | - | YB4L-B | - |
| 50 | SR Replica/Racing | -97 | - | - | YB4L-B | - |
| 50 | SR Stealth/WWW | -97 | - | - | YB4L-B | - |
| 50 | SR Urban/Viper | - | - | - | YB4L-B | - |
| 50 | SR50 | 00-01 | - | - | YB4L-B | - |

| CC | Model | Year | High Performance Maintenance Free | Maintenance Free VRLA | YuMicron | Conventional |
|--------------------------|----------------------------|-------|-----------------------------------|-----------------------|------------|--------------|
| APRILIA continued | | | | | | |
| 50 | SR 50 de | - | - | - | YB4L-B | - |
| 50 | SR50 Ditech | 01-05 | - | YTX5L-BS | - | - |
| 50 | Tuareg Rally/Wind | -97 | - | - | YB4L-B | - |
| 100 | Scarabeo 2T | 00 | - | YTX5L-BS | - | - |
| 100 | Scarabeo 4T | 00- | - | - | YB9-B | - |
| 100 | Scarabeo 4T USA | - | - | - | YB9-B | - |
| 125 | AF-1 Futura/Europa | -94 | - | - | YB9-B | - |
| 125 | AF-1 Project108/Replica | -94 | - | - | YB9-B | - |
| 125 | AF-1 Sintesi/Sport Pro | -94 | - | - | YB9-B | - |
| 125 | AS R | - | - | - | - | 12N5-3B |
| 125 | Atlantic | - | - | - | YB12AL-A | - |
| 125 | Classic | - | - | - | YB9-B | - |
| 125 | ETX (Electric-Starter) | - | - | - | YB9-B | - |
| 125 | ETX (Kick Starter) | - | - | - | - | 12N5.5-3B |
| 125 | Habana, Custome | - | - | YTX9-BS | - | - |
| 125 | Leonardo | 96-01 | - | - | YB12AL-A | - |
| 125 | Mojito | - | - | YTX7L-BS | - | - |
| 125 | Mojito FL | - | - | YTX7L-BS | - | - |
| 125 | MX 125 | - | - | - | YB4L-B | - |
| 125 | Pegaso | -95 | - | - | YB9-B | - |
| 125 | Rambla | 08 | - | YTX12-BS | - | - |
| 125 | Red Rose/Classic | -97 | - | - | YB9-B | - |
| 125 | RS Extrema, RX | -97 | - | - | YB9-B | - |
| 125 | RS Replica | -93 | - | - | YB9-B | - |
| 125 | RS125 | 95- | - | - | YB9-B | - |
| 125 | RS 125 11 KW | - | - | - | YB9-B | - |
| 125 | RS 125 F.P. | - | - | - | YB9-B | - |
| 125 | RS 125 F.P. USA | - | - | - | YB9-B | - |
| 125 | RX 125 11 KW | - | - | - | YB4L-B | - |
| 125 | RX 125 F.P. | - | - | - | YB4L-B | - |
| 125 | Scarabeo | 99-07 | - | - | YB12AL-A | - |
| 125 | Scarabeo | 08-12 | - | YTX12-BS | - | - |
| 125 | Scarabeo | 13- | - | - | YB12AL-A | - |
| 125 | Sport city | 08-12 | - | YT12B-BS | - | - |
| 125 | Sport city rest | - | - | YTX12-BS | - | - |
| 125 | SR125 | 99 | - | YTX7L-BS | - | - |
| 125 | SR MAX 125 | 13- | - | YTX12-BS | - | - |
| 125 | ST, STX (Electric-Starter) | - | - | - | YB9-B | - |
| 125 | ST, STX (Kick Starter) | - | - | - | - | 12N5.5-3B |
| 125 | ST/STX/ETX | - | - | - | - | 12N5.5-3B |
| 125 | SX 11 KW | - | - | - | YB4L-B | - |
| 125 | SX F.P. | - | - | - | YB4L-B | - |
| 125 | Tuareg (Electric-Starter) | - | - | - | YB9-B | - |
| 125 | Tuareg (Kick Starter) | - | - | - | - | 12N5.5-3B |
| 125 | Tuareg Rally | -86 | - | - | - | 6N4-2A-4 |
| 125 | Tuareg Rally | 87 | - | - | YB2.5L-C-2 | - |
| 125 | Tuareg Rally/Wind | 87-94 | - | - | YB9-B | - |
| 125 | Tuono | - | - | - | YB9-B | - |
| 150 | Leonardo | 99-02 | - | - | YB12AL-A | - |
| 150 | Mojito | - | - | YTX7L-BS | - | - |
| 150 | Scarabeo | 99- | - | - | YB12AL-A | - |
| 150 | SR 150 | 00 | - | YTX7L-BS | - | - |
| 200 | Atlantic | - | - | - | YB12AL-A | - |

World number one for motorcycle batteries

| CC | Model | Year | High Performance Maintenance Free | Maintenance Free VRLA | YuMicron | Conventional |
|--------------------------|------------------------|-------|-----------------------------------|-----------------------|----------|--------------|
| APRILIA continued | | | | | | |
| 200 | Scarabeo | 00- | - | - | YB12AL-A | - |
| 200 | Sport city | - | - | YT12B-BS | - | - |
| 200 | Sport city | 09- | - | YTX12-BS | - | - |
| 200 | Sport city rest | - | - | YTX12-BS | - | - |
| 250 | Atlantic | - | - | - | YB12AL-A | - |
| 250 | ETX (Electric-Starter) | - | - | - | - | 12N14-3A |
| 250 | ETX (Kick-Starter) | - | - | - | - | 12N5.5-3B |
| 250 | Leonardo, ST SP | 99- | - | - | YB12AL-A | - |
| 250 | Rambla | - | - | YTX12-BS | - | - |
| 250 | RS Replica | - | - | - | YB4L-B | - |
| 250 | RS 250 | 95-04 | - | - | YB4L-B | - |
| 250 | Scarabeo | -08 | - | - | YB12AL-A | - |
| 250 | Scarabeo | 08- | - | YTX12-BS | - | - |
| 250 | Scarabeo L | - | - | YTX12-BS | - | - |
| 250 | Sport city | 09-12 | - | YTX12-BS | - | - |
| 250 | Sport city rest | - | - | YTX12-BS | - | - |
| 300 | Scarabeo 300 S | 13- | - | YTX12-BS | - | - |
| 250 | Sport city USA | - | - | YTX12-BS | - | - |
| 250 | Sport city USA rest | - | - | YTX12-BS | - | - |
| 300 | Atlantic | 12- | - | - | YB12AL-A | - |
| 300 | Leonardo | - | - | - | YB12AL-A | - |
| 300 | Sport city rest | - | - | YTX12-BS | - | - |
| 350 | ETX (Electric-Starter) | - | - | - | YB14L-A2 | - |
| 350 | ETX (Kick-Starter) | - | - | - | - | 12N5.5-3B |
| 350 | Tuareg Wind | 87-88 | - | - | YB14L-A2 | - |
| 350 | Tuareg Wind | 88-94 | - | - | YB9-B | - |
| 400 | Atlantic | - | - | YTX12-BS | - | - |
| 400 | Scarabeo | - | - | YTX12-BS | - | - |
| 400 | Scarabeo L | - | - | YTX12-BS | - | - |
| 450 | Enduro | - | - | YTX7A-BS | - | - |
| 450 | Motard | - | - | YTX7A-BS | - | - |
| 450 | MXV | - | - | YTX7A-BS | - | - |
| 450 | RXV 450 | - | - | YTX7A-BS | - | - |
| 450 | RXV 450 CND | - | - | YTX7A-BS | - | - |
| 450 | RXV 450 USA | - | - | YTX7A-BS | - | - |
| 450 | SXV 450 | - | - | YTX7A-BS | - | - |
| 450 | SXV 450 CND | - | - | YTX7A-BS | - | - |
| 450 | SXV 450 US | - | YTZ10S | - | - | - |
| 500 | Atlantic | 03-05 | - | - | YB14L-A2 | - |
| 500 | Atlantic | 06- | - | YTX12-BS | - | - |
| 500 | Scarabeo | -08 | - | - | YB14L-A2 | - |
| 500 | Scarabeo | 08- | - | YTX12-BS | - | - |
| 500 | Scarabeo L | - | - | YTX12-BS | - | - |
| 500 | Scarabeo L USA | - | - | YTX12-BS | - | - |
| 550 | Enduro | - | - | YTX7A-BS | - | - |
| 550 | Motard | - | - | YTX7A-BS | - | - |
| 550 | RXV 550 | - | - | YTX7A-BS | - | - |
| 550 | RXV 550 CND | - | - | YTX7A-BS | - | - |
| 550 | RXV 550 USA | - | - | YTX7A-BS | - | - |
| 550 | SXV 550 | - | - | YTX7A-BS | - | - |
| 550 | SXV 550 CND | - | - | YTX7A-BS | - | - |
| 550 | SXV 550 USA | - | YTZ10S | - | - | - |
| 600 | ETX (Electric-Starter) | - | - | - | YB14L-A2 | - |

| CC | Model | Year | High Performance Maintenance Free | Maintenance Free VRLA | YuMicron | Conventional |
|--------------------------|---------------------------|-------|-----------------------------------|-----------------------|-----------|--------------|
| APRILIA continued | | | | | | |
| 600 | ETX (Kick Starter) | - | - | - | - | 12N5.5-3B |
| 600 | Pegaso | 88-94 | - | - | YB14L-A2 | - |
| 600 | Tuareg Wind | 87-91 | - | - | YB14L-A2 | - |
| 650 | ETX (Electric-Starter) | - | - | - | YB14L-A2 | - |
| 650 | ETX (Kick-Starter) | - | - | - | - | 12N5.5-3B |
| 650 | Moto 6.5 | 95-99 | - | - | YB12AL-A2 | - |
| 650 | Pegaso | 92-03 | - | - | YB12AL-A2 | - |
| 650 | Pegaso Strada | 05- | - | YTX12-BS | - | - |
| 650 | Pegaso/IE | 97-02 | - | - | YB12AL-A | - |
| 650 | Pegaso Factory | - | - | YTX12-BS | - | - |
| 650 | Pegaso Trail | - | - | YTX12-BS | - | - |
| 650 | Stark | 00- | - | - | YB14L-A2 | - |
| 750 | Dorsoduro | 09-16 | GYZ16H | YTX14-BS | - | - |
| 750 | Shiver | 09-16 | - | YTX12-BS | - | - |
| 800 | Mana | - | - | YTX14-BS | - | - |
| 839 | SRV 850 | 12- | - | YTX14-BS | - | - |
| 850 | Mana | - | - | YTX14-BS | - | - |
| 850 | Mana ABS | - | - | YTX14-BS | - | - |
| 850 | Mana CND | - | - | YTX14-BS | - | - |
| 850 | Mana USA | - | - | YTX14-BS | - | - |
| 900 | Dorsoduro | 17 | - | YTX14-BS | - | - |
| 900 | Shiver | 17 | - | YTX14-BS | - | - |
| 1000 | ETV Caponord | 02-03 | GYZ16H | YTX14-BS | - | - |
| 1000 | RST Futura | 01-04 | - | YTX12-BS | - | - |
| 1000 | RSV 1000 Factory | 04-05 | - | YTX12-BS | - | - |
| 1000 | RSV 1000 4V Factory | - | YTZ10S | - | - | - |
| 1000 | RSV 1000 Factory USA | - | - | YTX12-BS | - | - |
| 1000 | RSV 1000 Mille | 00 | - | YTX14-BS | - | - |
| 1000 | RSV 1000 Mille | 00-03 | - | YTX12-BS | - | - |
| 1000 | RSV 1000 Mille R | 00-05 | - | YTX12-BS | - | - |
| 1000 | RSV 1000 Mille SP | 99 | - | YTX12-BS | - | - |
| 1000 | RSV 1000 R | - | - | YTX12-BS | - | - |
| 1000 | RSV 1000 R USA | - | - | YTX12-BS | - | - |
| 1000 | RSV4 RR | 15 | - | YT12A-BS | - | - |
| 1000 | SL Falco | 00-03 | GYZ16H | YTX14-BS | - | - |
| 1000 | Tuono | 03-05 | - | YTX12-BS | - | - |
| 1000 | Tuono Fighter | 03- | - | YTX12-BS | - | - |
| 1000 | Tuono Factory | - | - | YTX12-BS | - | - |
| 1000 | Tuono Factory USA | - | - | YTX12-BS | - | - |
| 1000 | Tuono R | - | - | YTX12-BS | - | - |
| 1000 | Tuono RCND | - | - | YTX12-BS | - | - |
| 1000 | Tuono R USA | - | - | YTX12-BS | - | - |
| 1000 | Tuono V4 R ABS | 13- | - | YTX12A-BS | - | - |
| 1100 | Tuono V4 1100 | 14- | - | YT12A-BS | - | - |
| 1100 | Tuono V4 1100 RR | 14- | - | YT12A-BS | - | - |
| 1200 | Caponord | 11-16 | GYZ16H | YTX14-BS | - | - |
| 1200 | Dorsoduro 1200 ABS | 11-16 | GYZ16H | YTX14-BS | - | - |
| ATK | | | | | | |
| | All Electric Start Models | 96-01 | - | YTX7L-BS | - | - |
| | All Electric Start Models | 91-95 | - | YTX9-BS | - | - |

Can't find your vehicle listed?
Visit www.yuasa.com for our latest application data

| CC | Model | Year | High Performance Maintenance Free | Maintenance Free VRLA | YuMicron | Conventional |
|----------------|--------------------------|-------|-----------------------------------|-----------------------|----------|--------------|
| BAJAJ | | | | | | |
| 100 | BOXER UG | 03-05 | - | - | YB2.5L-C | - |
| 100 | CT100 BOXER | 05-12 | - | - | YB2.5L-C | - |
| 100 | PLATINO 100 | 08-12 | - | - | YB2.5L-C | - |
| 100 | BOXER BM100 CLASSIC KS | 12- | - | - | YB2.5L-C | - |
| 100 | BOXER BM100 CLASSIC ES | 12- | - | - | YB5L-B | - |
| 100 | DISCOVER 100 DTSi | 12- | - | - | YB5L-B | - |
| 125 | DISCOVER 125 DTSi | 08-12 | - | - | YB2.5L-C | - |
| 125 | XCD 125 | 09-12 | - | - | YB5L-B | - |
| 125 | PLATINO 125 | 10-12 | - | - | YB5L-B | - |
| 125 | DISCOVER 125 ST | 12- | - | - | YB5L-B | - |
| 135 | DISCOVER 135 KS | 09-12 | - | - | YB2.5L-C | - |
| 135 | DISCOVER 135 ES | 09-12 | - | - | YB5L-B | - |
| 135 | PULSAR 135LS | 09-12 | - | - | YB5L-B | - |
| 150 | BOXER BM150 | - | - | - | YB5L-B | - |
| 150 | PULSAR DTS-I | 08- | - | - | YB9-B | - |
| 180 | PULSAR 180 (ALL MODELS) | ALL | - | - | YB9-B | - |
| 200 | PULSAR 200 | - | - | - | YB9-B | - |
| 200 | PULSAR 200 NS | 12-13 | - | YTX9-BS | - | - |
| 220 | PULSAR 220F/S | - | - | - | YB9-B | - |
| BENELLI | | | | | | |
| 50 | 491GT/Sport/Racing | -97 | - | - | YB4L-B | - |
| 50 | Devil 50 (c/avv.) | - | - | - | YB4L-B | - |
| 50 | Devil (Electric-Starter) | 94-95 | - | - | YB4L-B | - |
| 50 | K2 | 97 | - | - | YB4L-B | - |
| 50 | KBX 50 Race | - | - | - | YB4L-B | - |
| 50 | Pepe | 00 | - | - | YB4L-B | - |
| 50 | Scooty LX/DLX | - | - | - | YB4L-B | - |
| 80 | Devil | 94-95 | - | - | YB4L-B | - |
| 80 | KBX | 94 | - | - | YB4L-B | - |
| 100 | K2 | 00- | - | - | YB5L-B | - |
| 125 | 125 Cross | - | - | - | - | 6N11A-1B |
| 125 | 125 Custom Guzzi | - | - | - | - | 12N5.5-4A |
| 125 | 125 Guzzi | - | - | - | - | 12N5.5-4A |
| 125 | 125 Jarno (c/avv.) | - | - | - | YB9-B | - |
| 125 | 125 Scooter | - | - | - | YB9L-B | - |
| 125 | 125-2 CSE | - | - | - | - | 6N11A-1B |
| 125 | 125CS | - | - | - | YB9-B | - |
| 125 | 125T Sport | - | - | - | - | 6N11A-1B |
| 125 | Adiva | 00 | - | YTX14-BS | - | - |
| 125 | Jarno (Electric-Starter) | 00 | - | - | - | 12N9-4B-1 |
| 125 | Velvet | 00 | - | YTX9-BS | - | - |
| 150 | Adiva 150 | 00 | - | YTX14-BS | - | - |
| 150 | Velvet | 00 | - | YTX9-BS | - | - |
| 250 | 4 Zyl. (Cylid.) | - | - | - | YB12A-A | - |
| 250 | TS250 | - | - | - | - | 6N11A-1B |
| 250 | Velvet | 00 | - | YTX12-BS | - | - |
| 254 | 4 Zyl. (Cylid.) | - | - | - | YB9-B | - |
| 350 | 350RS | 00 | - | - | 53030 | - |
| 354 | 4 Zyl. (Cylid.) | - | - | - | YB14L-A2 | - |
| 500 | LS | - | - | - | YB14L-A2 | - |
| 500 | Quattro | 00 | - | - | 53030 | - |
| 500 | SS | 00 | - | - | - | 12N12A-4A-1 |

| CC | Model | Year | High Performance Maintenance Free | Maintenance Free VRLA | YuMicron | Conventional |
|--------------------------|--------------------------|-------|-----------------------------------|-----------------------|-----------|--------------|
| BENELLI continued | | | | | | |
| 504 | 4 Zyl. (Cyl.) | - | - | - | YB14L-A2 | - |
| 650 | 650 Tornado U.T. | - | - | - | YB12A-A | - |
| 750 | Sei | 00 | - | - | YB14L-A2 | - |
| 750 | SS | 00 | - | - | - | 12N12A-4A-1 |
| 900 | 900 (6 Cilindri) | - | - | - | 53030 | - |
| 900 | Sei | - | - | - | 53030 | - |
| 900 | Tornado | - | - | - | - | 12N12A-4A-1 |
| BETAMOTOR | | | | | | |
| 50 | Adventure | - | - | - | YB4L-B | - |
| 50 | Ark Air/Ark Lc | -97 | - | - | YB4L-B | - |
| 50 | Chrono | 95 | - | - | YB4L-B | - |
| 50 | Eikon | 00 | - | - | YB4L-B | - |
| 50 | Quadra | -97 | - | - | YB4L-B | - |
| 50 | Tempo | - | - | - | YB4L-B | - |
| 125 | Eikon | 00- | - | YTX9-BS | - | - |
| 150 | Eikon | 00- | - | YTX9-BS | - | - |
| 600 | YB9 | 00- | - | - | YB12AL-A2 | - |
| 750 | SB3 | 00- | - | - | - | 12N14-3A |
| 900 | HS2900 | 00- | - | - | YB14L-A2 | - |
| 1000 | YB10 Dieci | 00- | - | YTX14-BS | - | - |
| 1000 | YB6 | - | - | - | YB14L-A2 | - |
| BIG DOG | | | | | | |
| All | All Models | All | YTX20HL (WC) | - | - | - |
| BIMOTA | | | | | | |
| 600 | YB9 | - | - | - | YB12AL-A2 | - |
| 900 | DB2 | 93-95 | - | - | YB14-A2 | - |
| 900 | DB2 Final Edition | 97 | - | - | YB14-A2 | - |
| 900 | DB3 Mantra | 97-99 | - | YTX7L-BS (x2) | - | - |
| 900 | DB4 | 98-00 | Not available | - | - | - |
| 900 | HS2900 | - | - | - | YB14L-A2 | - |
| 900 | Tesi | 91-95 | - | - | YB14-A2 | - |
| 996 | SB8R, SB8RS | 98-00 | - | YTX12-BS | - | - |
| 1000 | Gobert | - | - | - | YB14L-A2 | - |
| 1000 | Santamonica | - | - | - | YB14L-A2 | - |
| 1000 | Tesi 2d | - | - | - | YB14L-A2 | - |
| 1000 | YB10 DIECI | - | - | YTX14-BS | - | - |
| 1000 | YB11 | 96-99 | - | YTX12-BS | - | - |
| 1000 | YB8/YB10 | 92-95 | YTX14AHL-BS | - | - | - |
| 1100 | SB6, SB7 | 95-97 | - | YTX7L-BS (x2) | - | - |
| 1100 | SB6R | 97-99 | - | YTX12-BS | - | - |
| 1000 | YB6 | - | - | - | YB14L-A2 | - |
| BMW | | | | | | |
| 125 | C1 | 00- | - | - | YB14L-A2 | - |
| 150 | C1 | 00- | - | - | YB14L-A2 | - |
| 200 | C1 | 00- | - | - | YB14L-A2 | - |
| 250 | R25/2/3 | - | - | - | - | B49-6 |
| 260 | R26 | - | - | - | - | B39-6 |
| 260 | R26, R27 Single Cylinder | 55-69 | - | - | - | 6N11A-1B |

World number one for motorcycle batteries

| CC | Model | Year | High Performance Maintenance Free | Maintenance Free VRLA | YuMicron | Conventional |
|----------------------|----------------------------|-------|-----------------------------------|-----------------------|-----------|--------------|
| BMW continued | | | | | | |
| 260 | R27 | - | - | - | - | 6N11A-1B |
| 450 | R45N | 78-88 | - | YT19BL-BS | 51814* | - |
| 450 | G450X | 09- | YTZ7S | - | - | - |
| 500 | R50/2 Twin Cylinders | 55-69 | - | - | - | B38-6A |
| 500 | R50/5 | - | - | YT19BL-BS | 51814* | - |
| 500 | R50/R 50S/R 50-2/ | - | - | YT19BL-BS | 51814* | - |
| 500 | R50/S Twin Cylinders | 55-69 | - | - | - | B38-6A |
| 500 | R51/R51-2-3 | 00- | - | - | - | B49-6 |
| 600 | 60-5 | 00- | - | YT19BL-BS | 51814* | - |
| 600 | C600 | 11-12 | YTZ14S | - | - | - |
| 600 | C600, Sport | 13-16 | YTX14-BS | - | - | - |
| 600 | F650 | 93-01 | - | - | YB12AL-A2 | - |
| 600 | F650, S | 93- | - | - | 52515 | - |
| 600 | F650CS/GS/ST | 98-02 | - | - | YB12AL-A2 | - |
| 600 | R60, R60/2 Twin Cylinders | 55-69 | - | - | - | B38-6A |
| 600 | R60/5 | 70-73 | - | YT19BL-BS | 51814* | - |
| 600 | R60/6, R60/7 | -84 | - | - | 53030 | - |
| 600 | R60/6, R60/7 | 69-84 | - | - | 53030 | - |
| 600 | R60LS | 00- | - | YT19BL-BS | 51814* | - |
| 600 | R60S | 00- | - | - | - | 12N14-3A |
| 600 | R65 | 85- | - | - | 52515 | - |
| 600 | R65/GS | 86-92 | - | YT19BL-BS | 51814* | - |
| 600 | R65LS | 81-85 | - | YT19BL-BS | 51814* | - |
| 600 | R69S | - | - | - | - | B49-6 |
| 650 | C650GT | 11-16 | - | YTX14-BS | - | - |
| 650 | F650 | 93-08 | - | - | YB12AL-A2 | - |
| 650 | F650GS | 08-11 | - | - | YB12AL-A | - |
| 650 | R65 | 84-95 | - | - | 53030 | - |
| 650 | R65LS | 78-84 | - | YT19BL-BS | 51814* | - |
| 700 | R69 - R69S | 55-69 | - | - | - | B38-6A |
| 700 | F700GS | 11-16 | GYZ16H | YTX14-BS | - | - |
| 700 | F700GS (auxiliary battery) | 11-16 | YTZ14S | - | - | - |
| 750 | K75 | 85-86 | - | YT19BL-BS | 51814* | - |
| 750 | K75 | 87-92 | - | - | 52515 | - |
| 750 | K75 | 93-95 | - | YT19BL-BS | 51913* | - |
| 750 | K75, RT | 85-95 | - | - | 53030 | - |
| 750 | K75, -S, -RT, RTJ | - | - | - | 52515 | - |
| 750 | K75C | 85-86 | - | YT19BL-BS | 51814* | - |
| 750 | K75C | 87-93 | - | - | 52515 | - |
| 750 | K75C, S | 85-95 | - | YT19BL-BS | 51814* | - |
| 750 | K75RT | 92-96 | - | YT19BL-BS | 51913* | - |
| 750 | K75S | 85-86 | - | YT19BL-BS | 51814* | - |
| 750 | K75S | 87-92 | - | - | 52515 | - |
| 750 | R75/5 | 70-73 | - | YT19BL-BS | 51814* | - |
| 750 | R75/6 | 69-76 | - | - | 53030 | - |
| 750 | R75/6, R75/7 | -84 | - | - | 53030 | - |
| 750 | R75/7 | 76-84 | - | - | 53030 | - |
| 750 | R75-5 (Bicylinder) | 00- | - | YT19BL-BS | 51814* | - |
| 750 | R75-6 | 00- | - | - | 53030 | - |
| 800 | F800ST, GS, GT, R, ADV | 08-16 | GYZ16H | YTX14-BS | - | - |
| 800 | R80 | 86-92 | - | - | 52515 | - |
| 800 | R80 G/S | 81-86 | - | YT19BL-BS | 51814* | - |
| 800 | R80 G/S | 90-95 | - | - | 52515 | - |

* YT19BL-BS must be used on bikes fitted with ABS



| CC | Model | Year | High Performance Maintenance Free | Maintenance Free VRLA | YuMicron | Conventional |
|----------------------|-------------------------|-------|-----------------------------------|-----------------------|----------|--------------|
| BMW continued | | | | | | |
| 800 | R80, R80RT | 84-95 | - | - | 53030 | - |
| 800 | R80, R80RT | 85- | - | - | 52515 | - |
| 800 | R80/7, R80RT | -84 | - | - | 53030 | - |
| 800 | R80/7, R80RT | 78-84 | - | - | 53030 | - |
| 800 | R80ET | 00- | - | - | 53030 | - |
| 800 | R80GS | 88- | - | - | 52515 | - |
| 800 | R80GS, R80ST | 80-96 | - | YT19BL-BS | 51814* | - |
| 800 | R80R | 91-95 | - | - | 52515 | - |
| 800 | R80ST | 86-90 | - | YT19BL-BS | 51814* | - |
| 850 | R850R | 95-97 | - | YT19BL-BS | 51913* | - |
| 850 | R85C | 99-01 | - | YT19BL-BS | 51913* | - |
| 850 | R85R/RT/GS, R259 | 01 | - | YT19BL-BS | 51913* | - |
| 900 | R90/6, R90S | -84 | - | - | 53030 | - |
| 900 | R90/6, R90S | 69-76 | - | - | 53030 | - |
| 900 | R90ST | 00- | - | YT19BL-BS | 51814* | - |
| 1000 | All K Models | 83-93 | - | - | 53030 | - |
| 1000 | HP4 | 13-14 | YTZ7S | - | - | - |
| 1000 | K1 | 93 | - | YT19BL-BS | 51913* | - |
| 1000 | K1 | 89-92 | - | - | 52515 | - |
| 1000 | K100 | 83-94 | - | - | 52515 | - |
| 1000 | K100LT/RS | 83-91 | - | - | 52515 | - |
| 1000 | K100RT | 83-93 | - | - | 52515 | - |
| 1000 | R100 CS, RS, RT, S, T | -84 | - | - | 53030 | - |
| 1000 | R100, -CS | 80-84 | - | - | 52515 | - |
| 1000 | R100/7 | 76-84 | - | - | 53030 | - |
| 1000 | R100CS | 76-84 | - | - | 53030 | - |
| 1000 | R100GS, -Basic, -Mystic | 90-95 | - | - | 52515 | - |
| 1000 | R100GS, PD, R, RS, RT | 87-95 | - | - | 53030 | - |
| 1000 | R100PD | 90-95 | - | - | 52515 | - |
| 1000 | R100R | 00- | - | YT19BL-BS | 51913* | - |
| 1000 | R100R | 91-95 | - | - | 52515 | - |
| 1000 | R100RM | 91-95 | - | - | 52515 | - |
| 1000 | R100RT, R100RS | 87-94 | - | - | 52515 | - |
| 1000 | S1000R | 14- | YTZ10S | - | - | - |
| 1000 | S1000RR | 09-13 | YTZ10S | - | - | - |
| 1000 | S1000RR | 14-16 | YTZ7S | - | - | - |
| 1000 | S1000RR(DWA) | 09-11 | YTZ12S | - | - | - |
| 1000 | S1000RR(DWA) | 14-16 | YTZ10S | - | - | - |
| 1000 | S1000XR | 16 | - | YTX9-BS | - | - |
| 1000 | S1000XR(DWA) | 16 | YTZ10S | - | - | - |
| 1100 | K1100-LT | 93-98 | - | YT19BL-BS | 51913* | - |
| 1100 | K1100LT/RS | 90-95 | - | YT19BL-BS | 51913* | - |
| 1100 | K1100RS | 93-96 | - | YT19BL-BS | 51913* | - |
| 1100 | R1100GS | 94-00 | - | YT19BL-BS | 51913* | - |
| 1100 | R1100R, LT, RS, RT | 94-01 | - | YT19BL-BS | 51913* | - |
| 1100 | R1100RS, RT | 93- | - | YT19BL-BS | 51913* | - |
| 1100 | R1100S | 99-02 | - | YT19BL-BS | 51913* | - |
| 1150 | R1150 GS | 99-04 | - | YT19BL-BS | 51913* | - |
| 1150 | R1150 GS Adventure | 02-05 | - | YT19BL-BS | 51913* | - |
| 1150 | R1150GS, R | 00- | - | YT19BL-BS | 51913* | - |
| 1150 | R1150R/RS/RT | 01-05 | - | YT19BL-BS | 51913* | - |
| 1169 | HP2 | - | YTZ12S | - | - | - |
| 1170 | R nineT Scrambler | 14-16 | GYZ16H | YTX14-BS | - | - |

* YT19BL-BS must be used on bikes fitted with ABS

Can't find your vehicle listed?
Visit www.yuasa.com for our latest application data

| CC | Model | Year | High Performance Maintenance Free | Maintenance Free VRLA | YuMicron | Conventional |
|----------------------|--------------------------------|-------|-----------------------------------|-----------------------|-----------|--------------|
| BMW continued | | | | | | |
| 1200 | K1200 Cruiser | 98-02 | - | YT19BL-BS | 51913* | - |
| 1200 | K1200LT, GT, RS, S | 97- | - | YT19BL-BS | 51913* | - |
| 1200 | K1200LT, GT | 05-09 | - | YT19BL-BS | 51913* | - |
| 1200 | K1200R, S | 05-16 | GYZ16H | YTX14-BS | - | - |
| 1200 | R1200C, RT | 98- | - | YT19BL-BS | 51913* | - |
| 1200 | R1200GS, K1200R | 05-13 | GYZ16H | YTX14-BS | - | - |
| 1200 | R1200GS | 13-17 | YTZ14S | - | - | - |
| 1200 | R1200GS Adventure | 09- | YTZ14S | - | - | - |
| 1200 | R1200GS Adventure successor | 09- | YTZ14S | - | - | - |
| 1200 | R1200GS successor | 09- | YTZ14S | - | - | - |
| 1200 | R1200RS | 14-15 | GYZ16H | YTX14-BS | - | - |
| 1200 | R1200R successor | 09- | YTZ14S | - | - | - |
| 1200 | R1200RT | 05-13 | - | YT19BL-BS | 51913* | - |
| 1200 | R1200RT | 14-16 | GYZ16H | - | - | - |
| 1200 | R1200S, R | 05-16 | GYZ16H | YTX14-BS | - | - |
| 1200 | R1200R | 17- | YTZ14S | - | - | - |
| 1300 | K1300GT | 09-10 | - | YT19BL-BS | 51913* | - |
| 1300 | K1300R, S | 09-16 | GYZ16H | YTX14-BS | - | - |
| 1600 | K1600GT, GTL | 11-16 | - | YT19BL-BS | 51913* | - |
| BSA | | | | | | |
| - | 250, 350, 400, 441, 500 (12V) | - | - | - | YB7-A | 12N7-4A |
| - | 250, 350, 650 (6V) | - | - | - | - | B39-6 |
| - | 600, 650, 750 (12V) | - | - | - | YB7-A | - |
| - | Bantam | - | - | - | - | 6N5.5-1D |
| - | Rocket 750, Thunderbolt | - | - | - | YB9L-B | - |
| - | Spitfire HK35, Starfire B25 | - | - | - | YB9L-B | - |
| 500 | 500 Gold Star | - | - | - | - | B38-6A |
| 600 | 600 Gold Star | - | - | - | YB7-A | 12N7-4A |
| 650 | 650 Gold Star | - | - | - | YB7-A | 12N7-4A |
| 750 | 750 Gold Star | - | - | - | YB7-A | 12N7-4A |
| BSV | | | | | | |
| 50 | GP Dio, Sp Dio | - | - | YTX4L-BS | - | - |
| 50 | GZ | - | - | YTX4L-BS | - | - |
| 50 | ZX | 94-95 | - | YTX4L-BS | - | - |
| 100 | R100 S | 77-79 | - | - | 53030 | - |
| 100 | R100 T | 78-81 | - | - | 53030 | - |
| BUELL | | | | | | |
| 500 | Blast | 00-09 | YTX14H-BS | YTX14-BS | - | - |
| 984 | XB9R Firebolt, XB9SX Lightning | 02-10 | YTX14H (WC) | YTX14 (WC) | - | - |
| 1000 | RR1000 | 87 | YTX20H-BS | YTX20-BS | YB16-B-CX | - |
| 1125 | Buell Racing 1125RR | 09 | YTZ7S | - | - | - |
| 1125 | 1125R, 1125CR | 08-10 | - | YTX14L (WC) | - | - |
| 1200 | M2 Cyclone | 97-02 | YTX20HL-BS | YTX20L-BS | - | - |
| 1200 | RR1200 | 88-90 | YTX20H-BS | YTX20-BS | YB16-B-CX | - |
| 1200 | RS1200 | 89-93 | YTX20H-BS | YTX20-BS | YB16-B-CX | - |
| 1200 | RSS1200 | 91-93 | YTX20H-BS | YTX20-BS | YB16-B-CX | - |
| 1200 | S1 Lightning | 96-99 | YTX14H-BS** | YTX14-BS** | - | - |
| 1200 | S2, S2T Thunderbolt | 94-96 | YTX20H-BS | YTX20-BS | YB16-B-CX | - |
| 1200 | S3, S3T Thunderbolt | 97-02 | YTX20HL-BS | YTX20L-BS | - | - |

* YT19BL-BS must be used on bikes fitted with ABS **YTX14H-BS - Must use adapter kit available from Buell

| CC | Model | Year | High Performance Maintenance Free | Maintenance Free VRLA | YuMicron | Conventional |
|------------------------|---------------------------------|-------|-----------------------------------|-----------------------|-----------|--------------|
| BUELL continued | | | | | | |
| 1200 | X1 Lightning | 99-02 | YTX20HL (WC) | YTX20L (WC) | - | - |
| 1200 | XB12R Firebolt, XB12S Lightning | 04-10 | YTX14H (WC) | YTX14 (WC) | - | - |
| 1200 | XB12Ss, Scg, Lightning | 04-10 | YTX14H (WC) | YTX14 (WC) | - | - |
| 1200 | XB12X, XT Ulysses | 06-10 | YTX14H (WC) | YTX14 (WC) | - | - |
| CAGIVA | | | | | | |
| 50 | City, Lucky, Explorer | 94-97 | - | YTX4L-BS | - | - |
| 50 | Cocis, Prima, Supercity | - | - | - | YB5L-B | - |
| 50 | Cucciolo, Mito | 98 | - | - | YB4L-B | - |
| 50 | K3, W4 | 98 | - | - | YB4L-B | - |
| 50 | Prima | - | - | - | YB5L-B | - |
| 125 | Aletta Oro (Electric-Starter) | - | - | - | YB12A-A | - |
| 125 | Aletta Oro (Kick-Starter) | - | - | - | - | 12N5.5-4A |
| 125 | Blues, Elefantre | - | - | - | YB12A-A | - |
| 125 | Crouser, CUCC125 | 87-88 | - | - | YB9-B | - |
| 125 | Cuccido | - | - | - | YB9L-A2 | - |
| 125 | Elefant, SST, WSXT | - | - | - | - | 12N5.5-4A |
| 125 | EV | - | - | - | YB9-B | - |
| 125 | Freccia C9, /C10R, /C12R | 87-90 | - | - | YB9-B | - |
| 125 | K7, Passing | - | - | - | YB4L-B | - |
| 125 | Mito, -2, Replica, Ev. | 90-98 | - | - | YB9-B | - |
| 125 | Mitto125, R | 94-97 | - | - | YB9-B | - |
| 125 | N90 | 97 | - | - | YB9-B | - |
| 125 | Planet | 98 | - | - | YB9-B | - |
| 125 | Roadster | 94-97 | - | - | - | 12N5.5-4A |
| 125 | SM125 | 00 | - | YTX5L-BS | - | - |
| 125 | SST | - | - | - | - | 12N5.5-4A |
| 125 | SST Electra | - | - | - | YB12A-A | - |
| 125 | Supercity | 91-97 | - | - | YB9-B | - |
| 125 | SXT | - | - | - | - | 12N5.5-3B |
| 125 | Tamanaco | - | - | - | YB9-B | - |
| 125 | W8 | - | - | - | YB4L-B | - |
| 125 | Wre125 | 00 | - | YTX5L-BS | - | - |
| 125 | WSXT (Aletta Rossa) | - | - | - | - | 12N5.5-4A |
| 200 | Elefant | - | - | - | - | 12N5.5-4A |
| 200 | Roadstar | 95 | - | - | YB9-B | - |
| 250 | SST, SX | - | - | - | - | 12N7-3B |
| 300 | Elefant 2 Cyl. | 86- | - | - | YB14L-A2 | - |
| 300 | SST, SX | - | - | - | - | 12N7-3B |
| 300 | T4 Ala Rossa | - | - | - | - | 12N5.5-4A |
| 300 | T4 E Elefant, W12 | 93-97 | - | - | YB14L-A2 | - |
| 300 | T4 R | 87- | - | - | YB3L-A | - |
| 300 | W12 | - | - | - | YB14L-A2 | - |
| 350 | Elefant 2 Cyl. | 86- | YTX14AHL-BS | - | - | - |
| 350 | T4 E Elefant, W12 | 87- | YTX14AHL-BS | - | - | - |
| 350 | T4R | 87- | - | - | YB3L-A | - |
| 500 | Canyon, River | 98-01 | - | YTX14-BS | - | - |
| 500 | T4 E Elefant | 88- | YTX14AHL-BS | - | YB14L-A2 | - |
| 600 | Canyon, River | 95-96 | - | - | YB14L-A2 | - |
| 600 | Canyon, River | 96-97 | - | - | YB16AL-A2 | - |
| 600 | W16 | 94-97 | - | - | YB14L-A2 | - |
| 650 | Elefant | 86- | - | - | YB14L-A2 | - |
| 650 | Raptor/V Raptor | 00-02 | - | YTX12-BS | - | - |
| 650 | Raptor 650 | 03-04 | - | YTX9-BS | - | - |

World number one for motorcycle batteries

| CC | Model | Year | High Performance Maintenance Free | Maintenance Free VRLA | YuMicron | Conventional |
|----------------------------|----------------------------------|-------|-----------------------------------|-----------------------|-----------|--------------|
| CAGIVA continued | | | | | | |
| 750 | Elefant | 94-97 | - | - | YB16-B | - |
| 750 | Elefant Bifaro | 89- | YTX14AHL-BS | - | YB14L-A2 | - |
| 900 | Canyon I.E. | 98-00 | - | - | YB16-B | - |
| 900 | E900 | 94-97 | - | - | YB16AL-A2 | - |
| 900 | Elefant E900 | - | - | - | YB16B-A1 | - |
| 900 | Elefant, AC | 93-96 | - | - | YB16-B | - |
| 900 | Gran Canyon | 99 | - | - | YB16-B | - |
| 900 | I.E. GT | 91-93 | - | - | YB16-B | - |
| 1000 | Canyon I.E. | 97- | - | - | YB16-B | - |
| 1000 | Gran Canyon | - | - | YTX14-BS | - | - |
| 1000 | I.E. GT | 91-93 | - | - | YB16-B | - |
| 1000 | Navigator | 00-02 | - | - | YB16-B | - |
| 1000 | Raptor/V Raptor | 00-02 | - | YTX12-BS | - | - |
| 1000 | V Raptor | 03-04 | - | YTX9-BS | - | - |
| CAN-AM | | | | | | |
| 998 | Spyder | 08-16 | YTX24HL (WC) | - | - | - |
| 1330 | Spyder (RT,F3) | 14-16 | YTX24HL (WC) | - | - | - |
| CANNONDALE | | | | | | |
| 400 | EX400, MX400, XC400 | 00-01 | YTZ7S | YTX5L-BS | - | - |
| 440 | C440, E440, S440, X440, X440S | 02-03 | YTZ7S | - | - | - |
| CCM | | | | | | |
| 600 | All Electric Start Models Ô96-01 | 96-01 | - | YTX9-BS | - | - |
| CHANGZHOU GUANGYANG | | | | | | |
| 100 | CK100 | - | - | YTX5L-BS | - | - |
| 110 | CK110 | - | - | - | YB5L-B | - |
| 125 | CK125-CH | - | - | - | YB6L-B | - |
| 125 | CK125-T | - | - | YTX7A-BS | - | - |
| CHANSHA GUANGNAN | | | | | | |
| 50 | KN50QT | - | YTX4L-BS | YT4L-BS | - | - |
| 100 | KN100-2 | - | - | YTX5L-BS | - | - |
| 125 | KN125-T | - | - | YTX7A-BS | - | - |
| CHONGQING LONCIN | | | | | | |
| 90 | LX90,LX90J | - | - | - | YB5L-B | - |
| 100 | LX100-6 | - | - | - | YB6L-B | - |
| 110 | LX110-13A | - | - | YTX5L-BS | - | - |
| 110 | LX110-3D II | - | - | - | YB5L-B | - |
| 125 | LX125-10 | - | - | - | - | 12N7-3B |
| 125 | LX125-3A | - | - | - | - | 12N7-4B |
| 125 | LX125-5 | - | - | - | - | 12N9-4B-1 |
| 125 | LX125-16A | - | - | YTX7A-BS | - | - |
| 150 | LX150-16 | - | - | - | - | 12N7A-3A |
| 150 | LX150-2EV | - | - | - | YB7L-B | - |
| 150 | ATV150-M | - | - | - | - | 12N9-4B-1 |
| 200 | LX200-2 II | - | - | - | - | 12N7A-3A |
| 200 | LX200-3 | - | - | - | - | 12N7A-3A |
| 250 | JL250GY | - | - | YTX9-BS | - | - |

| CC | Model | Year | High Performance Maintenance Free | Maintenance Free VRLA | YuMicron | Conventional |
|-----------------------------------|---------------------|-------|-----------------------------------|-----------------------|------------|--------------|
| CHONGQING LONCIN continued | | | | | | |
| 250 | LX250Y-3 | - | - | YTX7L-BS | - | - |
| 90 | JL90 | - | - | - | YB5L-B | - |
| 125 | JL125-4 | - | - | - | YB6L-B | - |
| 125 | JL125-5A | - | - | - | - | 12N7-3B |
| 125 | JL125-61 | - | - | - | YB7-A | 12N7-4A |
| 150 | JL150 | - | - | - | - | 12N7A-3A |
| 150 | JL150-23 | - | - | - | YB7L-B | - |
| 150 | JL150-3A | - | - | - | - | 12N9-4B-1 |
| 150 | JL150-6A | - | - | - | - | 12N7-4B |
| 150 | JL150GY-6-B | - | - | YTX7L-BS | - | - |
| DACHANGJIANG | | | | | | |
| 100 | AX100 | - | - | - | - | 6N4-2A |
| 100 | HJ-110 | - | - | - | YB5L-B | - |
| 125 | GZ125HS | - | - | YTX7L-BS | - | - |
| 125 | HJ125F | - | - | - | YB7-A | - |
| 125 | HJ125J-8 | - | - | - | YB7-A | - |
| 125 | HJ125T-9 | - | - | YTX7A-BS | - | - |
| DAELIM | | | | | | |
| 125 | NS125 | 97- | - | YTX7A-BS | - | - |
| 125 | VC125 | 96 | - | - | YB9-B | - |
| 125 | VS125 | 97 | - | - | YB9-B | - |
| DERBI | | | | | | |
| 50 | All 50cc Models | - | - | - | YB4L-B | - |
| 125 | Boulevard 125 | - | - | - | YB9L-A2 | - |
| 150 | Boulevard 150 | - | - | - | YB9L-A2 | - |
| DUCATI | | | | | | |
| 75 | Cross | - | - | - | - | B38-6A |
| 75 | Six Days | - | - | - | - | 6N4-2A-4 |
| 129 | Aurea | - | - | - | - | B39-6 |
| 175 | Cross | - | - | - | - | B38-6A |
| 200 | Motocarro | - | - | - | - | 12N24-3A |
| 250 | Cross | - | - | - | - | B38-6A |
| 350 | Alazzurra | 87- | - | - | YB14L-A2 | - |
| 350 | Cross | - | - | - | - | B38-6A |
| 350 | F3 | 87- | - | - | YB14L-A2 | - |
| 350 | GTL, GTV Sport | - | - | - | Y50-N18L-A | - |
| 350 | Indiana, Pantah, XL | - | - | - | YB14L-A2 | - |
| 350 | Mark3, Scrambler | - | - | - | - | B38-6A |
| 350 | Sport | - | - | - | Y50-N18L-A | - |
| 350 | SS Supersport | 93- | - | - | YB16AL-A2 | - |
| 350 | Vento | - | - | - | YB12A-A | - |
| 400 | Alazzurra, F3 | 87- | - | - | YB14L-A2 | - |
| 400 | Monster | - | - | YT12B-BS | - | - |
| 400 | Scrambler 400 | 16 | - | YT12B-BS | - | - |
| 400 | SS Supersport | 91-99 | - | - | YB16AL-A2 | - |
| 400 | TS | - | - | - | - | B38-6A |
| 500 | GTL, GTV | - | - | - | Y50-N18L-A | - |
| 500 | Pantah | - | YTX14AHL-BS | - | YB14L-A2 | - |

Can't find your vehicle listed?
 Visit www.yuasa.com for our latest application data

| CC | Model | Year | High Performance Maintenance Free | Maintenance Free VRLA | YuMicron | Conventional |
|-------------------------|------------------------------|-------|-----------------------------------|-----------------------|------------|--------------|
| DUCATI continued | | | | | | |
| 500 | Sport | - | - | - | Y50-N18L-A | - |
| 600 | M Chromo | 98 | - | - | YB16AL-A2 | - |
| 600 | M City/M Dark/M Dark City | 98-00 | - | - | YB16AL-A2 | - |
| 600 | M Dark | 01 | - | YT12B-BS | - | - |
| 600 | Monster | 01 | - | YT12B-BS | - | - |
| 600 | Monster | 94-00 | - | - | YB16AL-A2 | - |
| 600 | Pantah | - | YTX14AHL-BS | - | YB14L-A2 | - |
| 600 | SS Supersport | 94-98 | - | - | YB16AL-A2 | - |
| 600 | TL | - | YTX14AHL-BS | - | YB14L-A2 | - |
| 620 | Monater/IE/S IE/Sport | 02-03 | - | YT12B-BS | - | - |
| 650 | Alazzurra, Indiana, Pantah | - | YTX14AHL-BS | - | YB14L-A2 | - |
| 696 | Monster 696 | - | - | YT12B-BS | - | - |
| 748 | Biposto | 01-03 | - | YT12B-BS | - | - |
| 748 | S R | 01-02 | - | YT12B-BS | - | - |
| 748 | Strada Biposto, SP, SPS | 97-00 | - | - | YB16AL-A2 | - |
| 749 | Superbike 749R, S | - | - | YT12B-BS | - | - |
| 750 | F1, Montijuich, Paso | 87-91 | YTX14AHL-BS | - | YB14L-A2 | - |
| 750 | GT, Luguna Seca | - | - | - | 53030 | - |
| 750 | Indiana | - | YTX14AHL-BS | - | YB14L-A2 | - |
| 750 | M City/M Dark/M Dark City | 99-00 | - | - | YB16AL-A2 | - |
| 750 | M Dark | 01 | - | YT12B-BS | - | - |
| 750 | M IE/M IE Dark | 02 | - | YT12B-BS | - | - |
| 750 | Monster | 01 | - | YT12B-BS | - | - |
| 750 | Monster | 95-00 | Not available | - | - | - |
| 750 | New Monster | - | - | YT12B-BS | - | - |
| 750 | Paso/F1 | 87-90 | - | - | YB14L-A2 | - |
| 750 | Sport | 01-02 | - | YT12B-BS | - | - |
| 750 | Sport | 89-90 | - | - | YB16AL-A2 | - |
| 750 | SS | 90-00 | - | - | YB16AL-A2 | - |
| 750 | SS IE | 00 | - | - | YB16AL-A2 | - |
| 750 | SS IE | 01-02 | - | YT12B-BS | - | - |
| 750 | SS Supersport (Kick-Starter) | - | - | - | YB12A-A | - |
| 750 | SS Veloce | 98 | - | - | YB16AL-A2 | - |
| 800 | Monster S | 03- | - | YT12B-BS | - | - |
| 800 | Monster S2R | 05 | - | YT12B-BS | - | - |
| 800 | Supersports | - | - | YT12B-BS | - | - |
| 803 | Hypermotard 796 | - | - | YT12B-BS | - | - |
| 803 | Monster 795 | - | - | YT12B-BS | - | - |
| 803 | Monster 796 | - | - | YT12B-BS | - | - |
| 803 | Monster 797 | 16 | - | YT12B-BS | - | - |
| 803 | Scrambler 800 | - | - | YT12B-BS | - | - |
| 803 | Scrambler 800 Cafe Racer | 16 | - | YT12B-BS | - | - |
| 803 | Scrambler 800 Desert Sled | 16 | - | YT12B-BS | - | - |
| 803 | Scrambler 800 Full Throttle | 15-16 | - | YT12B-BS | - | - |
| 803 | Scrambler 800 Icon | 15-16 | - | YT12B-BS | - | - |
| 803 | Scrambler 800 Real Enduro | 15-16 | - | YT12B-BS | - | - |
| 821 | Monster 821 | - | - | YT12B-BS | - | - |
| 821 | Hym | - | - | YT12B-BS | - | - |
| 849 | Streetfighter 848 | - | - | YT12B-BS | - | - |
| 849 | Superbike 848 EVO | - | - | YT12B-BS | - | - |
| 849 | Superbike 848 EVO Corse SE | - | - | YT12B-BS | - | - |
| 850 | Electric | - | - | - | Y60-N24L-A | - |
| 851 | Biposto/SP2/SPORT | 89-90 | - | - | YB16AL-A2 | - |

| CC | Model | Year | High Performance Maintenance Free | Maintenance Free VRLA | YuMicron | Conventional |
|-------------------------|---------------------------|-------|-----------------------------------|-----------------------|-----------|--------------|
| DUCATI continued | | | | | | |
| 851 | S Superbike | 91-92 | - | - | YB16AL-A2 | - |
| 851 | Strada | 89 | - | - | YB16AL-A2 | - |
| 851 | Superbike | 90-91 | - | - | YB16AL-A2 | - |
| 851 | Superbike, Strada | 89-90 | - | - | YB16B-A | - |
| 860 | GT, GTS | - | - | - | 53030 | - |
| 860 | Kick-Start | - | - | - | YB12A-A | - |
| 888 | SP, SP II, SP IV, SP V | 90-95 | - | - | YB16AL-A2 | - |
| 888 | Strada | 91-94 | - | - | YB16AL-A2 | - |
| 898 | Superbike Panigale | 14-16 | - | YT7B-BS | - | - |
| 898 | Superbike Panigale S | 15-16 | - | YT7B-BS | - | - |
| 900 | M Chromo | 01 | - | YT12B-BS | - | - |
| 900 | M Chromo | 98-00 | - | - | YB16AL-A2 | - |
| 900 | M City/M Dark/M Dark City | 99-00 | - | - | YB16AL-A2 | - |
| 900 | M Dark | 01 | - | YT12B-BS | - | - |
| 900 | M IE2/M IE DARK2 | 02 | - | YT12B-BS | - | - |
| 900 | M Metallic | 00 | - | - | YB16AL-A2 | - |
| 900 | M Metallic/M S | 01 | - | YT12B-BS | - | - |
| 900 | M Special | 98-00 | - | - | YB16AL-A2 | - |
| 900 | Monster | 00- | - | YT12B-BS | - | - |
| 900 | Monster, Superlight | 94-00 | - | - | YB16AL-A2 | - |
| 900 | SD Darmah | - | - | - | 53030 | - |
| 900 | SL | 92-96 | - | - | YB16AL-A2 | - |
| 900 | Sport | 02 | - | YT12B-BS | - | - |
| 900 | SS | 89-00 | Not available | - | - | - |
| 900 | SS (avviamento pedale) | - | - | - | - | 12N12A-4A-1 |
| 900 | SS IE | 00 | - | - | YB16AL-A2 | - |
| 900 | SS IE | 01-02 | - | YT12B-BS | - | - |
| 900 | SS (Kick-Starter) | -81 | - | - | YB12A-A | - |
| 900 | SS Replica | -81 | - | - | YB12A-A | 12N12A-4A-1 |
| 900 | SS Supersport, Replica | 82- | YTX14AHL-BS | - | YB14L-A2 | - |
| 900 | Supersport FE | 97-99 | - | - | YB16AL-A2 | - |
| 904 | Supersport 900 | 99 | - | - | YB16AL-A2 | - |
| 906 | Paso | 89-94 | - | - | YB14L-A2 | - |
| 906 | Paso | 90-92 | - | - | YB16-B | - |
| 907 | I.E. Paso | 90-94 | - | - | YB16-B | - |
| 916 | Biposto, Senna, Strada | 94-98 | - | - | YB16AL-A2 | - |
| 916 | I.E., SP, SP S | 94-98 | - | - | YB16AL-A2 | - |
| 916 | Monster S4 | 81-83 | - | YT12B-BS | - | - |
| 916 | ST4 | 01- | - | YT12B-BS | - | - |
| 916 | ST4 | 99-00 | - | - | YB16AL-A2 | - |
| 937 | Hypermotard | 15-16 | - | YT12B-BS | - | - |
| 937 | Hypermotard SP | 15-16 | - | YT12B-BS | - | - |
| 937 | Hyperstrada | 15-16 | - | YT12B-BS | - | - |
| 937 | Multistrada 950 | 16 | - | YT12B-BS | - | - |
| 937 | Supersport | 16- | - | YT12B-BS | - | - |
| 937 | Supersport S | 16- | - | YT12B-BS | - | - |
| 944 | Sport Touring 2 (ST2) | 97-00 | - | - | YB16AL-A2 | - |
| 944 | ST2 | 01-03 | - | YT12B-BS | - | - |
| 955 | Superbike Panigale | 16 | - | YT7B-BS | - | - |
| 992 | ST3 | - | - | YT12B-BS | - | - |
| 996 | 996, S, SPS | 99-00 | - | - | YB16AL-A2 | - |
| 996 | Monoposto | 99-00 | - | - | YB16AL-A2 | - |
| 996 | Monoposto, Bistro, S | 01- | - | YT12B-BS | - | - |

World number one for motorcycle batteries

| CC | Model | Year | High Performance Maintenance Free | Maintenance Free VRLA | YuMicron | Conventional |
|----------------------------|----------------------------------|-------|-----------------------------------|-----------------------|-----------|--------------|
| DUCATI continued | | | | | | |
| 996 | Sport Touring v4S | 01- | - | YT12B-BS | - | - |
| 996 | SPS/SPS2 | 99-00 | - | - | YB16AL-A2 | - |
| 996 | ST4S ABS | 01- | - | YT12B-BS | - | - |
| 998 | 998, 999, R, S | 02-03 | - | YT12B-BS | - | - |
| 998 | Monoposto/S/Biposto | 02-03 | - | YT12B-BS | - | - |
| 998 | ST4 | 01- | - | YT12B-BS | - | - |
| 1000 | Desmosedici RR | - | - | YT12B-BS | - | - |
| 1000 | Monster S2R | - | - | YT12B-BS | - | - |
| 1000 | Monster S4, S4RS, S4R | 03 | - | YT12B-BS | - | - |
| 1000 | Multistrada | 03 | - | YT12B-BS | - | - |
| 1000 | Supersport HF | 03 | - | YT12B-BS | - | - |
| 1078 | Hypermotard 1100 EVO | - | - | YT12B-BS | - | - |
| 1078 | Hypermotard 1100 EVO SP | - | - | YT12B-BS | - | - |
| 1078 | Monster 1100 EVO | - | - | YT12B-BS | - | - |
| 1078 | Monster Diesel | - | - | YT12B-BS | - | - |
| 1098 | 1098 | 07 | - | YTX14-BS | - | - |
| 1098 | Hypermotard 1100S | -07 | - | YT12B-BS | - | - |
| 1098 | Superbike 1098, S, Tricolore | -07 | - | YT12B-BS | - | - |
| 1099 | Streetfighter S | - | - | YT12B-BS | - | - |
| 1198 | Diavel | - | - | YT12B-BS | - | - |
| 1198 | Diavel Cromo | - | - | YT12B-BS | - | - |
| 1198 | Diavel Carbon | - | - | YT12B-BS | - | - |
| 1198 | Diavel Diesel | - | - | YT12B-BS | - | - |
| 1198 | Diavel AMG | - | - | YT12B-BS | - | - |
| 1198 | Monster 1200 | 14-16 | - | YT12B-BS | - | - |
| 1198 | Monster 1200 R | 15-16 | - | YT12B-BS | - | - |
| 1198 | Monster 1200 S | 15-16 | - | YT12B-BS | - | - |
| 1198 | Multistrada 1200 | - | - | YT12B-BS | - | - |
| 1198 | Multistrada 1200 S Sport | - | - | YT12B-BS | - | - |
| 1198 | Multistrada 1200 S Touring | - | - | YT12B-BS | - | - |
| 1198 | Multistrada 1200 S Touring D/Air | - | - | YT12B-BS | - | - |
| 1198 | Multistrada 1200 S Pikes Peak | - | - | YT12B-BS | - | - |
| 1198 | Superbike Panigale | - | - | YT7B-BS | - | - |
| 1198 | Superbike Panigale S | - | - | YT7B-BS | - | - |
| 1198 | Superbike Panigale S Tricolore | - | - | YT7B-BS | - | - |
| - | All other models | 01-07 | - | YT12B-BS* | - | - |
| 1199 | Superbike Panigale | 14- | - | YT7B-BS | - | - |
| 1262 | X Diavel | 15-16 | - | YT12B-BS | - | - |
| 1262 | X Diavel S | 15-16 | - | YT12B-BS | - | - |
| 1285 | Superbike Panigale | 15-16 | - | YT7B-BS | - | - |
| 1285 | Superbike Panigale S | 15-16 | - | YT7B-BS | - | - |
| E-TON | | | | | | |
| 50 | Beamer 50, Beamer III | 00-12 | YTZ7S | YTX5L-BS | - | - |
| 50 | Matrix 50 | -12 | YTZ7S* | YTX5L-BS | - | - |
| 50 | Sport 50 | -12 | - | YTX7A-BS | - | - |
| 150 | Sport 150 | -12 | - | YTX7A-BS | - | - |
| 150 | Matrix R4-150 | -12 | - | YTX9-BS | - | - |
| 150 | Beamer R4-150 | -12 | - | YTX9-BS | - | - |
| EXCELSIOR-HENDERSON | | | | | | |
| 1386 | Super X | 99-00 | YTX20HL-BS | YTX20L-BS | - | - |

*On some earlier models Hold Down may require modification

| CC | Model | Year | High Performance Maintenance Free | Maintenance Free VRLA | YuMicron | Conventional |
|---------------------|-----------------------------|-------|-----------------------------------|-----------------------|----------|--------------|
| FANTIC MOTOR | | | | | | |
| 50 | Grinta | 95-96 | YTX4L-BS | YT4L-BS | - | - |
| 50 | HP1 | - | - | - | YB4L-B | - |
| 50 | Koala | 93-97 | - | - | YB4L-B | - |
| 50 | Leader | 95 | YTX4L-BS | YT4L-BS | - | - |
| 50 | Oasis | - | - | - | YB4L-B | - |
| 50 | Oasis EPV | - | - | - | - | 12N5.5-3B |
| 50 | Pony, SR | 95 | - | - | YB4L-B | - |
| 50 | Queenie | 95 | YTX4L-BS | YT4L-BS | - | - |
| 50 | TX220 | - | - | - | - | B39-6 |
| 80 | Koala | 93-96 | - | - | YB4L-B | - |
| 125 | Raider LC | - | - | - | YB3L-A | - |
| 125 | Strada-Sport | 85 | - | - | - | 6N4B-2A |
| 250 | Raider LC | - | - | - | YB3L-A | - |
| GARELLI | | | | | | |
| 50 | Big Racing | 94 | - | - | YB4L-B | - |
| 50 | Big Wheel | 94-95 | - | - | YB4L-B | - |
| 50 | Grinta | 95-96 | YTX4L-BS | YT4L-BS | - | - |
| 50 | Noi | - | - | - | YB4L-B | - |
| 50 | Pony, Pony SR | 94-95 | - | - | YB4L-B | - |
| 50 | Queenie | 95 | YTX4L-BS | YT4L-BS | - | - |
| 50 | Sahel, Team, Urka | - | - | - | YB4L-B | - |
| 50 | XLE Tiger | - | - | - | YB4L-B | - |
| 125 | GTA (Electric-Starter) | - | - | - | YB9-B | - |
| 125 | GTA (Kick-Starter) | - | - | - | YB5L-B | - |
| 125 | TSR | - | - | - | - | 12N7-4B |
| 125 | XR Tiger (Electric-Starter) | - | - | - | YB9-B | - |
| 125 | XR Tiger (Kick-Starter) | - | - | - | YB5L-B | - |
| GAS GAS | | | | | | |
| 250 | Pampera | 96-01 | - | YTX4L-BS | - | - |
| 320 | Pampera | 98-01 | - | YTX4L-BS | - | - |
| 370 | Pampera | 97 | - | YTX4L-BS | - | - |
| GILERA | | | | | | |
| 50 | 503 | - | - | - | YB4L-B | - |
| 50 | Bullit, Easy Moving, Runner | -97 | - | - | YB4L-B | - |
| 50 | DNA | - | - | YTX4L-BS | - | - |
| 50 | Eaglet | 95-97 | - | - | YB4L-B | - |
| 50 | Easy Moving | - | - | - | YB4L-B | - |
| 50 | GSA (Electric-Starter) | - | - | - | YB4L-B | - |
| 50 | Ice | - | - | YTX4L-BS | - | - |
| 50 | Runner | 02- | - | YTX4L-BS | - | - |
| 50 | Runner | -97 | - | - | YB4L-B | - |
| 50 | Runner Purejet | 02- | - | - | YB9-B | - |
| 50 | Runner/SP | -97 | - | - | YB4L-B | - |
| 50 | Sioux El.-Starter | - | - | - | YB4L-B | - |
| 50 | Stalker, Storm, Top Rally | - | - | - | YB4L-B | - |
| 50 | Typhoon, X | -97 | - | - | YB4L-B | - |
| 125 | Apache (Electric-Starter) | - | - | - | YB9-B | - |
| 125 | Apache (Kick-Starter) | - | - | - | - | 12N5.5-3B |
| 125 | Arizona (Electric-Starter) | - | - | - | YB9-B | - |
| 125 | Arizona (Kick-Starter) | - | - | - | - | 12N5.5-3B |

Can't find your vehicle listed?
Visit www.yuasa.com for our latest application data

| CC | Model | Year | High Performance Maintenance Free | Maintenance Free VRLA | YuMicron | Conventional |
|-------------------------|--------------------------------|------|-----------------------------------|-----------------------|----------|--------------|
| GILERA continued | | | | | | |
| 125 | Coguar | 99 | - | - | YB9-B | - |
| 125 | Crono (Electric-Starter) | - | - | - | YB9-B | - |
| 125 | Crono (Kick-Starter) | - | - | - | - | 12N5.5-3B |
| 125 | CX (Electric-Starter) | - | - | - | YB9-B | - |
| 125 | CX (Kick-Starter) | - | - | - | - | 12N5.5-3B |
| 125 | DNA | - | - | - | YB10L-B | - |
| 125 | Fast Bike (Electric-Starter) | - | - | - | YB9-B | - |
| 125 | Fast Bike (Kick-Starter) | - | - | - | - | 12N5.5-3B |
| 125 | Freestyle (Electric-Starter) | - | - | - | YB9-B | - |
| 125 | Freestyle (Kick-Starter) | - | - | - | - | 12N5.5-3B |
| 125 | GFR (Electric-Starter) | - | - | - | YB9-B | - |
| 125 | GFR (Kick-Starter) | - | - | - | - | 12N5.5-3B |
| 125 | GR1 | - | - | - | - | 6N11A-3A |
| 125 | KK, KZ (Electric-Starter) | - | - | - | YB9-B | - |
| 125 | KK, KZ (Kick-Starter) | - | - | - | - | 12N5.5-3B |
| 125 | MX1, MXR (Electric-Starter) | - | - | - | YB9-B | - |
| 125 | MX1, MXR (Kick-Starter) | - | - | - | - | 12N5.5-3B |
| 125 | Nebraska (Electric-Starter) | - | - | - | YB9-B | - |
| 125 | Nebraska (Kick-Starter) | - | - | - | - | 12N5.5-3B |
| 125 | R1, R1S (Electric-Starter) | - | - | - | YB9-B | - |
| 125 | R1, R1S (Kick-Starter) | - | - | - | - | 12N5.5-3B |
| 125 | RC Rally | - | - | - | YB10L-B | - |
| 125 | RTX, RV, RX (Electric-Starter) | - | - | - | YB9-B | - |
| 125 | RTX, RV, RX (Kick-Starter) | - | - | - | - | 12N5.5-3B |
| 125 | Runner FX, SP | - | - | - | YB9-B | - |
| 125 | Runner VX4T | - | - | YT12B-BS | - | - |
| 125 | RV (Electric-Starter) | - | - | - | YB9-B | - |
| 125 | RV (Kick-Starter) | - | - | - | - | 12N5.5-3B |
| 125 | RTX (Electric-Starter) | - | - | - | YB9-B | - |
| 125 | RTX (Kick-Starter) | - | - | - | - | 12N5.5-3B |
| 125 | SP01,SP02 (Electric-Starter) | - | - | - | YB9-B | - |
| 125 | SP01,SP02 (Kick-Starter) | - | - | - | - | 12N5.5-3B |
| 125 | TG1 | - | - | - | - | 6N11A-3A |
| 125 | TOP Rally (Electric-Starter) | - | - | - | YB9-B | - |
| 125 | TOP Rally (Kick-Starter) | - | - | - | - | 12N5.5-3B |
| 125 | Typhoon | - | - | - | YB7-A | - |
| 125 | X | - | - | - | YB9-B | - |
| 125 | XR1, XR2 (Electric-Starter) | - | - | - | YB9-B | - |
| 125 | XR1, XR2 (Kick-Starter) | - | - | - | - | 12N5.5-3B |
| 180 | Runner FXR, SP | - | - | - | YB10L-B | - |
| 180 | Runner SP | 99 | - | YTX12-BS | - | - |
| 180 | Runner VXR4T | - | - | YT12B-BS | - | - |
| 200 | Arizona (Electric-Starter) | - | - | - | - | 12N5.5-3B |
| 200 | Arizona (Kick-Starter) | - | - | - | YB9-B | - |
| 200 | Fast Bike (Electric-Starter) | - | - | - | - | 12N5.5-3B |
| 200 | Fast Bike (Kick-Starter) | - | - | - | YB9-B | - |
| 200 | Motocarro | - | - | - | - | B38-6A |
| 200 | RTX, RV, RX (Electric-Starter) | - | - | - | YB9-B | - |
| 200 | RTX, RV, RX (Kick-Starter) | - | - | - | - | 12N5.5-3B |
| 200 | RV (Electric-Starter) | - | - | - | YB9-B | - |
| 200 | RV (Kick-Starter) | - | - | - | - | 12N5.5-3B |
| 200 | T4 | - | - | - | - | 12N5.5-3B |
| 250 | Arizona Rally | - | - | - | YB10L-B | - |

| CC | Model | Year | High Performance Maintenance Free | Maintenance Free VRLA | YuMicron | Conventional |
|-------------------------|---------------------------|------|-----------------------------------|-----------------------|----------|--------------|
| GILERA continued | | | | | | |
| 250 | RV NGR (Electric-Starter) | - | - | - | YB10L-B | - |
| 250 | RV NGR (Kick-Starter) | - | - | - | - | 12N5.5-3B |
| 350 | Dakota (Electric-Starter) | - | - | - | YB10L-A2 | - |
| 350 | Dakota (Kick-Starter) | - | - | - | - | 12N5.5-3B |
| 350 | ER (Electric-Starter) | - | - | - | YB10L-A2 | - |
| 350 | ER (Kick-Starter) | - | - | - | - | 12N5.5-3B |
| 350 | XRT | - | - | - | YB14L-A2 | - |
| 500 | Dakota (Electric-Starter) | - | - | - | YB10L-A2 | - |
| 500 | Dakota (Kick-Starter) | - | - | - | - | 12N5.5-3B |
| 600 | Nordwest | 93 | - | - | YB14L-A2 | - |
| 600 | RC600C | 93 | - | - | YB14L-A2 | - |
| 600 | Top Rally, XRT | - | - | - | YB14L-A2 | - |
| GUANGYANG MOTOR | | | | | | |
| 50 | CK50 | - | - | YT4L-BS | - | 12N7-4B |
| 100 | CK100 | - | - | YTX5L-BS | - | - |
| 110 | CK110 | - | - | - | YB5L-B | - |
| 110 | KK110 | - | - | - | YB5L-B | - |
| 125 | KK125-2L | - | - | - | YB6L-B | - |
| 125 | KN125-2 | - | - | - | - | 12N7A-3A |
| 125 | KN125T, KK125T | - | - | YTX7A-BS | - | - |
| 125 | CK125-2B | - | - | - | - | 12N7A-3A |
| 125 | CK125-2H | - | - | - | YB6L-B | - |
| 125 | CK125-6 | - | - | - | - | 12N7-3B |
| 125 | CK125T, CK125-2F | - | - | YTX7A-BS | - | - |
| 150 | CK150 | - | - | YTX9-BS | - | - |
| GUANGZHOU HUANAN | | | | | | |
| - | FYFY | - | - | YTX4L-BS | - | - |
| - | FYJ | - | - | - | - | 12N9-4B-1 |
| - | FYLS/FYFSB | - | - | YTX7L-BS | - | - |
| - | FYT3A | - | - | YTX5L-BS | - | - |
| - | H2100 | - | - | YTX7A-BS | - | - |
| HAOJIN | | | | | | |
| 50 | HJ50QT | - | - | - | YB6L-B | - |
| 100 | HJ100-3 | - | - | - | YB5L-B | - |
| 100 | HJ100 | - | - | - | YB6L-B | - |
| 100 | HJ100T-E | - | - | YTX7A-BS | - | - |
| 100 | HJ100T-A | - | - | YTX7A-BS | - | - |
| 110 | HJ110 | - | - | - | YB5L-B | - |
| 125 | HJ125 | - | - | - | YB6L-B | - |
| 125 | HJ125-2,3,5,9,10,15,18 | - | - | - | - | 12N9-4B-1 |
| 125 | HJ125-7,6,6A | - | - | - | YB7-A | - |
| 125 | HJ125T,-3,8,B,D,2D,2G | - | - | YTX7A-BS | - | - |
| 125 | HJ125T-11 | - | - | - | YB6L-B | - |
| 125 | HJ125-A,-22 | - | - | - | - | 12N7A-3A |
| 150 | HJ150-9,10 | - | - | - | - | 12N9-4B-1 |
| 150 | HJ150ST | - | - | YTX9-BS | - | - |
| 250 | HJ250 | - | - | - | - | 12N9-4B-1 |

World number one for motorcycle batteries

| CC | Model | Year | High Performance Maintenance Free | Maintenance Free VRLA | YuMicron | Conventional |
|------------------------|--------------------------------------|-----------|-----------------------------------|-----------------------|---------------|--------------|
| HARLEY-DAVIDSON | | | | | | |
| 90 | Z90 | 73-76 | - | - | YB7L-B | 12N7-3B |
| 125 | SS125, SX125 | 74-78 | - | - | YB7L-B | 12N7-3B |
| 125 | SXT125 | 75-78 | - | - | YB7L-B | 12N7-3B |
| 125 | TX125 | 73-78 | - | - | YB7L-B | 12N7-3B |
| 175 | SS175, SX175 | 74-78 | - | - | YB7L-B | 12N7-3B |
| 250 | SS250, SX250 | 75-78 | - | - | YB7L-B | 12N7-3B |
| 350 | SS350 | All Years | - | - | - | 6N11A-1B |
| 500 | MT500 (Military) | All Years | YTX14AHL-BS | - | YB14L-A2 | - |
| 500 | Street | 14-16 | GYZ16HL | YTX14L-BS | - | - |
| 750 | Street | 14-16 | GYZ16HL | YTX14L-BS | - | - |
| 883 | XL, XLH (Sportster) | 04-16 | GYZ16HL | YTX14L-BS | - | - |
| 883 | XL, XLH (Sportster) | 97-03 | GYZ20HL | YTX20L-BS | - | - |
| 883 | XLH (Sportster) | 86-96 | YTX20H-BS* | YTX20-BS* | YB16-B-CX | YB16-B |
| 1000 | XL Series (Sportster) | 79-85 | YTX20H-BS* | YTX20-BS* | YB16-B-CX | YB16-B |
| 1000 | XLCH Series (Sportster Kick-Starter) | 70-78 | - | - | YB7-A | 12N7-4A |
| 1000 | XLCR Cafe Racer | 77-78 | YTX20H-BS* | YTX20-BS* | YB16-B-CX | YB16-B |
| 1000 | XLH (Sportster Electric-Starter) | 67-78 | - | - | - | YHD-12 |
| 1000 | 1000 XLX-61, XR1000 | 83-85 | YTX20H-BS* | YTX20-BS* | YB16-B-CX | YB16-B |
| 1100 | XL Series (Sportster) | 87-93 | YTX20H-BS* | YTX20-BS* | YB16-B-CX | YB16-B |
| 1130 | VRSC V-Rod | 02-07 | GYZ16H | - | - | - |
| 1200 | FL/FLH Series (Touring) | 65-77 | - | - | - | YHD-12 |
| 1200 | FX Series (Electric-Starter) | 71-78 | YTX20H-BS* | YTX20-BS* | YB16-B-CX | YB16-B |
| 1200 | FX Series (Kick-Starter) | 71-72 | - | - | YB7-A | 12N7-4A |
| 1200 | XL, XLH (Sportster) | 04-16 | GYZ16HL | YTX14L-BS | - | - |
| 1200 | XL, XLH (Sportster) | 97-03 | GYZ20HL | YTX20L-BS | - | - |
| 1200 | XL, XLH (Sportster) | 87-96 | YTX20H-BS* | YTX20-BS* | YB16-B-CX | - |
| 1200 | XR 1200X | 09-12 | GYZ16HL | YTX14L-BS | - | - |
| 1250 | VRSC V-Rod | 08-16 | GYZ20HL | - | - | - |
| 1340 | FL, FLH Series (Touring) | 80-96 | YTX24HL-BS | - | Y50-N18L-A-CX | - |
| 1340 | FL, FLH Series (Touring) | 97-98 | GYZ32HL | YIX30L-BS | YB30L-B | - |
| 1340 | FL, FLH Series (Touring) | 78-84 | - | - | - | YHD-12 |
| 1340 | FLST Series (Softail) | 97-99 | YTX20HL-BS | YTX20L-BS | - | - |
| 1340 | FLST Series (Softail) | 91-96 | YTX20HL-BS* | YTX20L-BS* | YB16HL-A-CX | - |
| 1340 | FX/FXR Series | 79-94 | YTX20H-BS* | YTX20-BS* | YB16-B-CX | YB16-B |
| 1340 | FXD/FXST Series (Dyna) | 97-99 | GYZ20HL | YTX20L-BS | - | - |
| 1340 | FXD/FXST Series (Dyna) | 91-96 | YTX20HL-BS* | YTX20L-BS* | YB16HL-A-CX | - |
| 1340 | FXR Series | 99-00 | YTX20H-BS* | YTX20-BS* | YB16-B-CX | YB16-B |
| 1340 | FXST/FLST Series (Softail) | 84-90 | YTX20H-BS* | YTX20-BS* | YB16-B-CX | YB16-B |
| 1450 | FL, FLH Series (Touring) | 00-06 | GYZ32HL | YIX30L-BS | - | - |
| 1450 | FL, FLH Series (Touring) | 99 | GYZ32HL | YIX30L-BS | YB30L-B | - |
| 1450 | FXD Series (Dyna) | 99-06 | GYZ20HL | YTX20L-BS | - | - |
| 1450 | FXST, FLST Series (Softail) | 00-06 | GYZ20HL | YTX20L-BS | - | - |
| 1584 | FL, FLH Series (Touring) | 07-10 | GYZ32HL | YIX30L-BS | - | - |
| 1584 | FXD Series (Dyna) | 07-11 | GYZ20HL | YTX20L-BS | - | - |
| 1584 | FXST, FLST Series (Softail) | 07-11 | GYZ20HL | YTX20L-BS | - | - |
| 1690 | FLH, FLT (Touring) | 11-16 | GYZ32HL | YIX30L-BS | - | - |
| 1690 | FXD (Dyna) | 12-16 | GYZ20HL | YTX20L-BS | - | - |
| 1690 | FLS (Softail) | 12-16 | GYZ20HL | YTX20L-BS | - | - |
| 1803 | CVO FLH (Touring) | 07-16 | GYZ32HL | YIX30L-BS | - | - |
| 1803 | CVO FLST (Softail) | 07-15 | GYZ20HL | YTX20L-BS | - | - |
| 1803 | CVO FXD (Dyna) | 07-15 | GYZ20HL | YTX20L-BS | - | - |
| 1803 | FLS (Softail Slim S, Fay Boy S) | 16 | GYZ20HL | YTX20L-BS | - | - |

* Requires use of cover/spacer kit



| CC | Model | Year | High Performance Maintenance Free | Maintenance Free VRLA | YuMicron | Conventional |
|-------------------------|--------------------------------|-------|-----------------------------------|-----------------------|----------|---------------|
| HEINKEL | | | | | | |
| 600 | 150, R103, Tourist 103A/Z | - | - | - | - | 6N11A-3A (x2) |
| 600 | Scooter Tourist | - | - | - | - | 6N11A-3A |
| HERCULES (SACHS) | | | | | | |
| 50 | CV City | - | - | - | - | 6YB8L-B |
| 50 | FOX | 93 | - | - | YB5L-B | - |
| 50 | Gipsy | 95 | - | - | YB4L-B | - |
| 50 | KX5 | 93-97 | - | - | YB4L-B | - |
| 50 | Limbo L, M, MA, ML | 95-97 | - | - | YB4L-B | - |
| 50 | Reggage, Reggage Splinter | 96-97 | - | - | YB4L-B | - |
| 50 | Samba, Swing | 94-97 | - | - | YB4L-B | - |
| 50 | Ultra | - | - | - | - | 12N9-3B |
| 80 | CV City | - | - | - | - | 6N11-2D |
| 80 | RX 9 | - | - | - | YB5L-B | - |
| 80 | SR Samba | 94-96 | - | - | YB5L-B | - |
| 80 | Ultra AC, F, RS | - | - | - | - | 12N9-3B |
| 125 | 125E | - | - | - | - | 6N11A-1B |
| 125 | K103, K105X | - | - | - | - | 6N11A-1B |
| 125 | K125 S-RT, T-RT | - | - | - | - | 6N11A-1B |
| 125 | K125X Military | - | - | - | - | 6N11A-1B |
| 125 | SR125 Samba | 94-97 | - | - | YB5L-B | - |
| 125 | W2000 Wankel | - | - | - | YB18L-A | - |
| HMZ | | | | | | |
| 50 | Cab | 96 | YTX4L-BS | YT4L-BS | - | - |
| HONDA | | | | | | |
| 50 | ASTREA STAR | 94 | - | - | YB4L-B | - |
| 50 | Benly 50 | 11- | - | YTX5L-BS | - | - |
| 50 | Bite | 01- | YTZ7S | - | - | - |
| 50 | C100, T, CA100, T, C110, CA110 | 59-69 | - | - | - | 6N2-2A |
| 50 | C110 | 09 | YTZ7S | - | - | - |
| 50 | C50SW | 94 | - | - | YB4L-B | - |
| 50 | C50Z, Z2 | 79-80 | - | - | - | 6N4-2A-4 |
| 50 | CB50 J, J (B) | 79-81 | - | - | - | 6N4-2A-4 |
| 50 | CB50J, F | 81 | - | - | - | 6N2-2A |
| 50 | CD50 | 82 | - | - | - | 6N4-2A-4 |
| 50 | CF50 | 82 | - | - | - | 6N4-2A-4 |
| 50 | CHF50 | 09- | YTZ7S | - | - | - |
| 50 | CHF50 Metropolitan, II, SP | 02-12 | YTZ7S | - | - | - |
| 50 | CRM50 | 93-94 | - | - | YB3L-A | - |
| 50 | Dio | 12- | - | YTX4L-BS | - | - |
| 50 | Dio Cesta | 11- | - | YTX4L-BS | - | - |
| 50 | Dio Z4 | -02 | YTZ7S | - | - | - |
| 50 | Dio50 (SP50 Dio) | 93-94 | YTX4L-BS | YT4L-BS | - | - |
| 50 | Dunk | - | YTZ6V | - | - | - |
| 50 | EVC50 | 10- | - | YT4L-BS | - | - |
| 50 | Fifty | - | - | - | YB4L-B | - |
| 50 | Giorcub | 01- | YTZ7S | - | - | - |
| 50 | Giorno Crea | -3 | YTZ7S | - | - | - |
| 50 | Giorno (A-AF24) | 92- | - | YTR4A-BS | - | - |
| 50 | Giorno (JBH-AF70) | 11- | - | YTX4L-BS | - | - |

Can't find your vehicle listed?
Visit www.yuasa.com for our latest application data

| CC | Model | Year | High Performance Maintenance Free | Maintenance Free VRLA | YuMicron | Conventional |
|------------------------|----------------------------|-------|-----------------------------------|-----------------------|------------|--------------|
| HONDA continued | | | | | | |
| 50 | Gorilla | 01- | - | YTR4A-BS | - | - |
| 50 | GP Dio | 00- | - | YTX4L-BS | - | - |
| 50 | Gyro Canopy (TA02) | 00- | - | YTX7L-BS | - | - |
| 50 | Gyro Canopy (JBH-TA03) | 08- | YTZ7S | - | - | - |
| 50 | Gyro Up | 00- | - | YTX4L-BS | - | - |
| 50 | Gyro X | 00- | - | YTX4L-BS | - | - |
| 50 | Gyro X Standard | 08- | YTZ7S | - | - | - |
| 50 | Jorno | - | YTZ6V | - | - | - |
| 50 | Julio | 01- | YTZ7S | - | - | - |
| 50 | KGB | -99 | YTZ7S | - | - | - |
| 50 | Lead | -01 | YTX4L-BS | YT4L-BS | - | - |
| 50 | Lead | 01- | YTZ7S | - | - | - |
| 50 | Little Cub | 00- | YTX4L-BS | YT4L-BS | - | - |
| 50 | MB5 | 82 | - | - | YB2.5L-C | - |
| 50 | MB50 S (A) | 80 | - | - | - | 6N4-2A-7 |
| 50 | MBX50FW, FWD, S, SD, SWD | 85-87 | - | - | YB3L-A | - |
| 50 | Monkey | 93- | - | YTR4A-BS | - | - |
| 50 | Monkey | - | - | YTX4L-BS | - | - |
| 50 | MT50S, T | 92-93 | - | - | - | 6N4-2A-12 |
| 50 | MT50S | 90-91 | - | - | - | 6N4-2A-7 |
| 50 | MTX50 S (E) | 84 | - | - | YB2.5L-C | - |
| 50 | MTX50FR, RS, S | 85-89 | - | - | YB3L-A | - |
| 50 | NA50 Express II | 79 | - | - | - | 6N2-2A |
| 50 | NA50 Express II | 80-81 | - | - | - | 6N4-2A-8 |
| 50 | NB50 Aero | 85-87 | - | YTX4L-BS | - | - |
| 50 | NB50, M | 83-87 | YTX4L-BS | YT4L-BS | - | - |
| 50 | NB50M Aero | 83-84 | - | - | YB4L-B | - |
| 50 | NC50 Express | 77 | - | - | - | 6N2A-2C-3 |
| 50 | NC50 Express | 78-79 | - | - | - | 6N2-2A |
| 50 | NCH50 Metropolitan | 13-16 | - | YTX4L-BS | - | - |
| 50 | ND50 M | 82 | - | - | YB4L-B | - |
| 50 | NH50 MS | 86-98 | - | - | YB4L-B | - |
| 50 | NJ50 | - | YTZ7S | - | - | - |
| 50 | NN50MD Gyro | 84 | - | - | YB4L-B | - |
| 50 | NPS50 | 10- | YTZ7S | - | - | - |
| 50 | NP50, M Sky | -97 | - | - | YB4L-B | - |
| 50 | NPS50, S Ruckus | 03-16 | YTZ7S | - | - | - |
| 50 | NQ50 Spree | 84-85 | - | - | YB4L-B | - |
| 50 | NQ50 Spree, 50D SS | 86-87 | - | YTX4L-BS | - | - |
| 50 | NQ50, M | 85 | - | - | YB4L-B | - |
| 50 | NQ50, M | 86-87 | YTX4L-BS | YT4L-BS | - | - |
| 50 | NS50F, NS 1 | 90-99 | - | - | YB3L-A | - |
| 50 | NSR50, A, F | 87-95 | - | - | YB3L-A | - |
| 50 | NU50 Urban Express | 82-83 | - | - | YB2.5L-C-1 | - |
| 50 | NU50M Urban Express Deluxe | 82-83 | - | - | YB4L-B | - |
| 50 | NX50M Express SR | 81-82 | - | - | YB4L-B | - |
| 50 | P50 Little Honda | 67-68 | - | - | - | 6N4-2A-4 |
| 50 | PA50 I, II | 78-83 | - | - | - | 6N4B-2A-5 |
| 50 | PK Wallaroo | - | - | YTX4L-BS | - | - |
| 50 | PK50, M, SM | 90-99 | YTX4L-BS | YT4L-BS | - | - |
| 50 | Press Cub | - | YTX4L-BS | YT4L-BS | - | - |
| 50 | PX50 MS | 84 | - | - | YB4L-B | - |
| 50 | PXR | - | - | - | YB4L-B | - |

| CC | Model | Year | High Performance Maintenance Free | Maintenance Free VRLA | YuMicron | Conventional |
|------------------------|----------------------|-------|-----------------------------------|-----------------------|----------|--------------|
| HONDA continued | | | | | | |
| 50 | SA Vision | - | - | YTX4L-BS | - | - |
| 50 | SA50 Elite LX, S, SR | 88-01 | - | YTX4L-BS | - | - |
| 50 | SB50 (All) | 88-90 | - | YTX4L-BS | - | - |
| 50 | SC01 | 97 | YTX4L-BS | YT4L-BS | - | - |
| 50 | SC01 | 01- | - | YTX4L-BS | - | - |
| 50 | SE50 | 88-89 | YTX4L-BS | YT4L-BS | - | - |
| 50 | SE50 Elite (All) | 87 | - | YTX4L-BS | - | - |
| 50 | SFX50 Sport | 95-99 | - | YTR4A-BS | - | - |
| 50 | SG50M | 90 | YTX4L-BS | YT4L-BS | - | - |
| 50 | SGX50 Sky | 97 | YTX4L-BS | YT4L-BS | - | - |
| 50 | SH50 | 87-89 | - | - | YB4L-B | - |
| 50 | SH50 Scoopy | 96-97 | - | YTR4A-BS | - | - |
| 50 | SH50 Scoopy, Crea | 01- | YTZ7S | - | - | - |
| 50 | Shadow 50 | 97 | YTX4L-BS | YT4L-BS | - | - |
| 50 | Shadow 50 | 01- | - | YTX4L-BS | - | - |
| 50 | SJ50 Bali | -97 | - | YTR4A-BS | - | - |
| 50 | SK50, M | 92-94 | YTX4L-BS | YT4L-BS | - | - |
| 50 | SK50, M | 97-98 | - | YTR4A-BS | - | - |
| 50 | Sky | 00- | - | YTX4L-BS | - | - |
| 50 | Sky Dax | 99 | YTX4L-BS | YT4L-BS | - | - |
| 50 | Sky Vetro | 99 | - | YTR4A-BS | - | - |
| 50 | SP Dio | - | - | YTX4L-BS | - | - |
| 50 | SR50 | 97- | - | YTX4L-BS | - | - |
| 50 | ST50 Dax | 88-97 | YTX4L-BS | YT4L-BS | - | - |
| 50 | Super Cub 50 | 07- | YTX4L-BS | YT4L-BS | - | - |
| 50 | SXR | - | - | YTR4A-BS | - | - |
| 50 | SZX50 | 00 | - | YTR4A-BS | - | - |
| 50 | Tact | 01- | YTZ7S | - | - | - |
| 50 | Tact | - | YTZ6V | - | - | - |
| 50 | TC50 | 00- | - | YTX7L-BS | - | - |
| 50 | TG50 Gyro S (All) | 85-86 | - | YTX4L-BS | - | - |
| 50 | Today | - | - | YTX4L-BS | - | - |
| 50 | Vision 50 | 93-94 | YTX4L-BS | YT4L-BS | - | - |
| 50 | X8R-X/X8R-S | 99- | - | YTR4A-BS | - | - |
| 50 | Z50J | 92 | - | YTR4A-BS | - | - |
| 50 | Z50J, 2, 3 | 79-91 | - | - | - | 6N2A-2C-3 |
| 50 | ZB50 | 88 | - | YTX4L-BS | - | - |
| 50 | ZB50P Monkey | 88 | YTX4L-BS | YT4L-BS | - | - |
| 50 | Zoomer | 01- | YTZ7S | - | - | - |
| 50 | ZX50 | 94- | - | YTR4A-BS | - | - |
| 55 | C, CA105T Trail | 62-65 | - | - | - | 6N2-2A |
| 65 | S65 Sport (CS65) | 65-69 | - | - | - | 6N2-2A |
| 70 | C70 Passport | 80-81 | - | - | 6YB11-2D | 6N11-2D |
| 70 | C70 Passport | 82-83 | - | - | YB5L-B | - |
| 70 | C70, DM | 82-84 | - | - | YB5L-B | - |
| 70 | C70CM | 83-84 | - | - | - | 6N4-2A-4 |
| 70 | C70CMP | 97 | - | - | YB4L-B | - |
| 70 | C70M | 70-73 | - | - | 6YB11-2D | 6N11-2D |
| 70 | C70-MA | 90 | - | - | - | 6N4-2A-4 |
| 70 | C70W | 95 | - | - | YB4L-B | - |
| 70 | C70Z, Z2 | 79-93 | - | - | - | 6N4-2A-4 |
| 70 | CD70 | 81 | - | - | - | 6N4-2A-4 |
| 70 | CD70 II PK | 92 | - | - | YB2.5L-C | - |

World number one for motorcycle batteries

| CC | Model | Year | High Performance Maintenance Free | Maintenance Free VRLA | YuMicron | Conventional |
|------------------------|-----------------------|-------|-----------------------------------|-----------------------|----------|--------------|
| HONDA continued | | | | | | |
| 70 | CF70 | 82 | - | - | - | 6N4-2A-7 |
| 70 | CT70 | 91-94 | - | YTX4L-BS | - | - |
| 70 | CT70 (Canada) | 86 | - | - | - | 6N4-2A-4 |
| 70 | CT70 (Canada) | 91-94 | YTX4L-BS | YT4L-BS | - | - |
| 70 | CT70 Trail | 74-79 | - | - | - | 6N4C-1B |
| 70 | CT70 Trail | 80-82 | - | - | - | 6N4-2A-8 |
| 70 | CT70 Trail, 70H | 69-71 | - | - | - | 6N2A-2C |
| 70 | CT70, 70H | 72-73 | - | - | - | 6N2A-2C-3 |
| 70 | SL70 Motosport | 73 | - | - | - | 6N2A-2C-3 |
| 70 | SL70 Motosport | 71-72 | - | - | - | 6N2A-2C |
| 70 | ST70 | 89-94 | YTX4L-BS | YT4L-BS | - | - |
| 70 | ST70 Dax | 80- | - | - | - | 6N2-2A-8 |
| 70 | XL70 | 74-76 | - | - | - | 6N4C-1B |
| 75 | CRM75, MTX75R | 89-94 | - | - | YB3L-A | - |
| 75 | MBX75 FW | 83 | - | - | YB3L-A | - |
| 75 | NSR75 | 92-94 | - | - | YB3L-A | - |
| 75 | SA75M | 91 | YTX4L-BS | YT4L-BS | - | - |
| 75 | Scoopy 75 | 93-94 | - | - | YB5L-B | - |
| 75 | SH75 | 87-89 | - | - | YB5L-B | - |
| 75 | XL75 | 77-79 | - | - | - | 6N4C-1B |
| 80 | CH80 | - | YTX5L-BS | YT5L-BS | - | - |
| 80 | CH80 Elite | 93-07 | - | YTX5L-BS | - | - |
| 80 | MB80 S | 80 | - | - | - | 6N4-2A-7 |
| 80 | MBX80 SW, SWD, 2, FWD | 85-87 | - | - | YB3L-A | - |
| 80 | MCX80 S | 83 | - | - | YB3L-A | - |
| 80 | MT80 S | 80 | - | - | - | 6N4-2A-7 |
| 80 | MTX80 C | 82 | - | - | YB2.5L-C | - |
| 80 | MTX80 R2, RS | 87 | - | - | YB3L-A | - |
| 80 | NH80 Aero | 85 | - | YTX5L-BS | - | - |
| 80 | NH80 MD, SD, MS | 86-94 | - | - | YB5L-B | - |
| 80 | NH80MD Aero | 83-84 | - | - | YB5L-B | - |
| 80 | XL80 | 85-90 | - | - | - | 6N4-2A-8 |
| 80 | XL80 (USA) | 80-82 | - | - | - | 6N4C-1B |
| 80 | XL80 (USA) | 83-85 | - | - | - | 6N4-2A-8 |
| 80 | XL80S | 80-82 | - | - | - | 6N4C-1B |
| 80 | XL80S | 83-85 | - | - | - | 6N4-2A-8 |
| 90 | C200 Touring 90 | 63-66 | - | - | - | 6N6-1D |
| 90 | C90 CW | 95 | - | - | YB4L-B | - |
| 90 | C90 D, Z | 92-93 | - | - | - | 6N4-2A-4 |
| 90 | C90, M | 82-93 | - | - | YB5L-B | - |
| 90 | CL90, L 5HP Scrambler | 67-70 | - | - | - | 6N5.5-1D |
| 90 | CM91 90 (C90M) | 66-69 | - | - | - | 6N6-1B |
| 90 | CT200 Trail 90 | 64-66 | - | - | - | 6N5.5-1D |
| 90 | CT90 Trail | 66-79 | - | - | - | 6N5.5-1D |
| 90 | EZ90 Cub | 91-96 | - | YTX5L-BS | - | - |
| 90 | S90 Super (CS90) | 64-69 | - | - | - | 6N6-1B |
| 90 | Shadow 90 | - | - | YTX5L-BS | - | - |
| 90 | Shadow 90 | 99 | YTX4L-BS | YT4L-BS | - | - |
| 90 | SL90 Motosport | 69 | - | - | - | 6N5.5-1D |
| 90 | ST90 Trail Sport | 73-75 | - | - | - | 6N5.5-1D |
| 90 | Super Cub | - | YTX4L-BS | YT4L-BS | - | - |
| 90 | TH90T | 96 | YTX4L-BS | YT4L-BS | - | - |
| 100 | Ape 100 | - | YTX4L-BS | YT4L-BS | - | - |

| CC | Model | Year | High Performance Maintenance Free | Maintenance Free VRLA | YuMicron | Conventional |
|------------------------|-------------------|-------|-----------------------------------|-----------------------|----------|--------------|
| HONDA continued | | | | | | |
| 100 | BC100 | - | YTX4L-BS | YT4L-BS | - | - |
| 100 | C100-M | 88-92 | - | - | YB5L-B | - |
| 100 | C100-MA | 87 | YTX4L-BS | YT4L-BS | - | - |
| 100 | C100-TH | 92 | YTX4L-BS | YT4L-BS | - | - |
| 100 | CB100 | 94 | - | - | - | 6N6-3B |
| 100 | CB100 | 70- | - | - | - | 6N6-3B-1 |
| 100 | CB100 N | 81 | - | - | - | 6N6-3B |
| 100 | CB100 Super Sport | 70-72 | - | - | - | 6N6-3B |
| 100 | CG-100 | 80 | - | - | - | 6N6-3B |
| 100 | CL100 S Scrambler | 70-73 | - | - | - | 6N6-3B |
| 100 | EX Bali | 97 | YTX5L-BS | YT5L-BS | - | - |
| 100 | GL-100 | 81- | - | - | - | 6N6-3B |
| 100 | GL100 II | 83 | - | - | YB2.5L-C | - |
| 100 | H100 S | 86-88 | - | - | - | 6N4-2A-7 |
| 100 | Lead | 08 | - | YTX7L-BS | - | - |
| 100 | Lead EX | 10- | - | YTX7L-BS | - | - |
| 100 | NF100, M | 97 | - | YTX5L-BS | - | - |
| 100 | NH100-1D | 98 | - | YTX5L-BS | - | - |
| 100 | NH100-1D | 84- | - | - | YB5L-B | - |
| 100 | SCV100 | 03- | - | YTX5L-BS | - | - |
| 100 | SH100 | 00 | - | YTX5L-BS | - | - |
| 100 | SH100 Scoopy | 96 | YTX5L-BS | YT5L-BS | - | - |
| 100 | SJ Bali EX | - | YTX5L-BS | YT5L-BS | - | - |
| 100 | SL100 Motosport | 70-73 | - | - | - | 6N6-3B |
| 100 | SPACY | 12 | YTZ4V | - | - | - |
| 100 | XL100 | 74-76 | - | - | - | 6N6-3B |
| 100 | XL100 | 77-78 | - | - | - | 6N4C-1B |
| 100 | XL100 | 85-90 | - | - | - | 6N4C-1B |
| 100 | XL100S | 79-80 | - | - | - | 6N4-2A-4 |
| 100 | XL100S | 81-82 | - | - | - | 6N4C-1B |
| 100 | XL100S | 83-85 | - | - | - | 6N4-2A-4 |
| 100 | WIN | 87- | - | - | - | 6N4-2A-4 |
| 110 | Air Blade | 08 | YTZ5S | - | - | - |
| 110 | BEAT | 08 | YTZ4V, YTZ5S | - | - | - |
| 110 | BEAT POP ISS | 15 | YTZ6V | - | - | - |
| 110 | Benry 110 | 12- | - | YTX4L-BS | - | - |
| 110 | Benry 110 | - | - | YTX7L-BS | - | - |
| 110 | C110 | 09 | YTZ7S | - | - | - |
| 110 | C110B | 10- | YTZ7S | - | - | - |
| 110 | Click | 08 | YTZ5S | - | - | - |
| 110 | CRF110F | 13-16 | YTZ5S | YTX4L-BS | - | - |
| 110 | Cross Cub | - | - | YTX4L-BS | - | - |
| 110 | Super Cub 110 | - | - | YTX4L-BS | - | - |
| 110 | Super Cub 110 Pro | - | - | YTX4L-BS | - | - |
| 110 | CT110 Trail | 86 | - | - | - | 6N4-2A-4 |
| 110 | CT110 Trail | 80-84 | - | - | - | 6N4-2A-8 |
| 110 | Dio 110 | 11- | - | YTX7L-BS | - | - |
| 110 | Dio 110 | - | YTZ6V | - | - | - |
| 110 | LS110-TH | 89-92 | - | - | YB3L-A | - |
| 110 | NHX110 Elite | 10-13 | - | YTX7L-BS | - | - |
| 110 | NT110MV | 97 | - | - | YB4L-B | - |
| 110 | NT110V | 97 | - | - | YB2.5L-C | - |
| 110 | NZ110 M, MS | 93 | - | - | YB2.5L-C | - |

Can't find your vehicle listed?
 Visit www.yuasa.com for our latest application data

| CC | Model | Year | High Performance Maintenance Free | Maintenance Free VRLA | YuMicron | Conventional |
|------------------------|--------------------------|-------|-----------------------------------|-----------------------|----------|--------------|
| HONDA continued | | | | | | |
| 110 | NZ110 MM | 93 | - | - | YB4L-B | - |
| 110 | NZ110 S, S1, RS | 89-92 | - | - | YB2.5L-C | - |
| 110 | NZ110-TH | 87 | - | - | YB2.5L-C | - |
| 110 | Supra | 08 | YTZ5S | - | - | - |
| 110 | Super Cub 110 | 09- | YTZ7S | - | - | - |
| 110 | Super Cub 110 Pro | 09- | YTZ7S | - | - | - |
| 110 | TH110-MA, M | 91 | - | - | YB2.5L-C | - |
| 110 | Vision 110 | - | - | YTX7L-BS | - | - |
| 110 | Wave 110 | 08 | YTZ5S | - | - | - |
| 110 | Zoomer X | - | YTZ6V | - | - | - |
| 125 | BLADE 125 | 10- | YTZ4V | - | - | - |
| 125 | CA125 | 95-96 | - | YTX7L-BS | - | - |
| 125 | CA125 Rebel | 95-97 | - | YTX7L-BS | - | - |
| 125 | CB Italia | - | - | - | - | 6N6-3B |
| 125 | CB125 B6 | - | - | - | - | 6N12A-2D |
| 125 | CB125 K | - | - | - | - | 6N12A-2D |
| 125 | CB125 RS | 83 | - | - | YB2.5L-C | - |
| 125 | CB125 S, S III-V | 79-82 | - | - | - | 6N6-3B |
| 125 | CB125 S2, J, N | -79 | - | - | - | 6N6-3B |
| 125 | CB125 T, T II | 80-81 | - | - | - | 6N6-3B |
| 125 | CB125 T, T II | 90-93 | - | - | - | 12N9-4B-1 |
| 125 | CB125 TD | 82 | - | - | YB9-B | - |
| 125 | CB125N | 79 | - | - | - | 6N6-3B-1 |
| 125 | CB125S | 76 | - | - | - | 6N6-3B-1 |
| 125 | CB125S | 73-80 | - | - | - | 6N6-3B |
| 125 | CB125S | 81-82 | - | - | - | 6N6-3B-1 |
| 125 | CBR125R | 04 | YTZ6V | - | - | - |
| 125 | CBX/Endurance | - | - | - | - | 6N6-3B |
| 125 | CD125 T | 81-82 | - | - | YB9-B | 12N9-4B-1 |
| 125 | CG125 (Electric-Starter) | - | - | YTX5L-BS | - | - |
| 125 | CG125 (Kick-Stater) | - | YTX4L-BS | YT4L-BS | - | - |
| 125 | CG125, -IR | 92 | - | - | YB3L-A | - |
| 125 | CG125, -IR | 80-91 | - | - | - | 6N6-3B |
| 125 | CH125 | 84 | - | - | YB9-B | - |
| 125 | CH125 Elite | 84 | - | - | YB9-B | - |
| 125 | CH125 Spacy | 88-95 | - | YTX9-BS | - | - |
| 125 | CHA125T | 96 | - | YTX9-BS | - | - |
| 125 | City Fly | 98 | - | YTX5L-BS | - | - |
| 125 | CL125 Scrambler | 73-75 | - | - | - | 6N4C-1B |
| 125 | CL125A Scrambler (Twin) | 67-69 | - | - | - | B54-6 |
| 125 | CLR125 | -99 | - | YTX5L-BS | - | - |
| 125 | CM125 C | 82-94 | - | - | - | 12N9-4B-1 |
| 125 | CMX | - | - | YTX7L-BS | - | - |
| 125 | CRF125F | 14-16 | YTZ5S | YTX4L-BS | - | - |
| 125 | CRM | - | - | YTX4L-BS | - | - |
| 125 | CRM125 R | 90 | YTX4L-BS | YT4L-BS | - | - |
| 125 | CS | - | - | - | - | 6N6-3B |
| 125 | CS1 | 08 | YTZ5S | - | - | - |
| 125 | CT125, Trail | 77-89 | - | - | - | 6N4C-1B |
| 125 | FES125 | 00 | - | YTX9-BS | - | - |
| 125 | FES125, Panteon | 03- | - | YTX7L-BS | - | - |
| 125 | GL125 II, -IN | 87-97 | - | - | YB2.5L-C | - |
| 125 | GROM | 13- | YTZ5S | - | - | - |



| CC | Model | Year | High Performance Maintenance Free | Maintenance Free VRLA | YuMicron | Conventional |
|------------------------|--------------------------|-------|-----------------------------------|-----------------------|------------|--------------|
| HONDA continued | | | | | | |
| 125 | KIRANA | 04 | YTZ5S | - | - | - |
| 125 | Lead 125 | - | YTZ8V | - | - | - |
| 125 | MBX125 F | 85 | - | - | YB5L-B | - |
| 125 | MT125 Elsinore | 74-76 | - | - | - | 6N6-3B |
| 125 | MTX125 RW, RW-TH | 85-90 | - | - | YB3L-A | - |
| 125 | MTX125, R, R2 | 86-87 | - | - | YB5L-B | - |
| 125 | NES125, Dylan | 00- | - | YTX7L-BS | - | - |
| 125 | NH125 Aero | 84 | - | - | YB5L-B | - |
| 125 | NH125 Lead | 83-86 | - | - | YB5L-B | - |
| 125 | NS125 F | 89 | - | - | YB5L-B | - |
| 125 | NS125 R, R2, R3 | 87 | - | - | YB5L-B | - |
| 125 | NSR125 F III/R/R2/Raiden | 92 | - | YTX5L-BS | - | - |
| 125 | NSR125 R | 97 | - | YTX5L-BS | - | - |
| 125 | NX125 | - | - | - | - | 12N9-4B-1 |
| 125 | NX125 | 88-90 | YTZ8V | YTX7L-BS | - | - |
| 125 | NX125 Transcity | 97 | - | YTX7L-BS | - | - |
| 125 | NXR125 | - | - | YTX5L-BS | - | - |
| 125 | NZ125 | 93 | - | - | YB3L-A | - |
| 125 | Pantheon 125 | 99 | - | YTX9-BS | - | - |
| 125 | PCX 125 | 10-13 | YTZ7S | - | - | - |
| 125 | PCX 125 | 14- | YTZ8V | - | - | - |
| 125 | SES125 | 00- | - | YTX7L-BS | - | - |
| 125 | SH125 | 01-12 | - | YTX7L-BS | - | - |
| 125 | SH125 | 13- | YTZ7S | - | - | - |
| 125 | Shadow 125 | 99 | - | YTX7L-BS | - | - |
| 125 | SL125 Motosport | 71-73 | - | - | - | 6N6-3B |
| 125 | SONIC 125 | - | - | YTX4L-BS, YTX5L-BS | - | - |
| 125 | Spacy 125 | 01- | YTZ12S | - | - | - |
| 125 | SS125A Super Sport | 67-69 | - | - | - | B54-6 |
| 125 | SUPRA X 125 | 06 | YTZ5S | - | - | - |
| 125 | TL125 | 88 | - | - | - | 6N2-2A |
| 125 | TMX125 | 85 | - | - | - | 6N6-3B |
| 125 | VT125 Shadow | - | - | YTX7L-BS | - | - |
| 125 | VT125C | 01- | YTZ7S | - | - | - |
| 125 | WW125EX | 10- | YTZ7S | - | - | - |
| 125 | XL125 | 74-78 | - | - | - | 6N4C-1B |
| 125 | XL125 | 85-90 | - | - | - | 6N4C-1B |
| 125 | XL125 S | 79-82 | - | - | - | 6N4-2A-4 |
| 125 | XL125 S | 84 | - | - | - | 6N4C-1B |
| 125 | XL125R/Pais Dakar | 85-87 | - | - | - | 12N9-4B-1 |
| 125 | XL125SD | - | - | - | YB2.5L-C-2 | - |
| 125 | XLR125R | 98 | - | YTX7A-BS | - | - |
| 125 | XLV125 Valadero | 01- | YTZ7S | - | - | - |
| 135 | HX135, -TH | 84-87 | - | - | YB2.5L-C | - |
| 145 | GL145 II | 83-88 | - | - | YB2.5L-C | - |
| 150 | CBX150 S | 88 | - | - | YB7L-B | - |
| 150 | CB 150R | 14 | YTZ6V | - | - | - |
| 150 | CBR 150R | 14 | YTZ6V | - | - | - |
| 150 | CG150 Titan | - | - | YTX7L-BS | - | - |
| 150 | CH150 Elite | 87 | - | YTX9-BS | - | - |
| 150 | CH150 Elite Deluxe | 85-86 | - | - | YB9-B | - |
| 150 | CRF150F | 06-16 | YTZ7S | YTX5L-BS | - | - |
| 150 | FES150 | 99-02 | - | YTX9-BS | - | - |

World number one for motorcycle batteries

| CC | Model | Year | High Performance Maintenance Free | Maintenance Free VRLA | YuMicron | Conventional |
|------------------------|-------------------------|-------|-----------------------------------|-----------------------|----------|--------------|
| HONDA continued | | | | | | |
| 150 | FES150 | 03- | - | YTX7L-BS | - | - |
| 150 | Foresight 150 | - | - | YTX7L-BS | - | - |
| 150 | MEGA PRO | 12 | YTZ5S | - | - | - |
| 150 | MEGA PRO ELECTRIC STAR | 10 | - | - | YB7B-B | - |
| 150 | NES150 | 03- | - | YTX7L-BS | - | - |
| 150 | NES150 Z | 01 | - | YTX7L-BS | - | - |
| 150 | NSR150, R, R2 | 89 | - | - | YB2.5L-C | - |
| 150 | NSR150, R, R2 | 94-98 | - | - | YB3L-A | - |
| 150 | NX150 | 89 | - | - | YB7L-B | - |
| 150 | Pantheon | - | - | YTX9-BS | - | - |
| 150 | PCX 150 | 12-13 | YTZ7S | - | - | - |
| 150 | PCX 150 | 14- | YTZ8V | - | - | - |
| 150 | SES150 | 00- | - | YTX7L-BS | - | - |
| 150 | SH150 | 10-13 | - | YTX7L-BS | - | - |
| 150 | SH150 | 13- | YTZ7S | - | - | - |
| 150 | XLR150 | 00- | - | YTX5L-BS | - | - |
| 150 | VERZA 150 | 14 | YTZ5S | - | - | - |
| 156 | GL156S | 95 | - | - | YB2.5L-C | - |
| 160 | CB160 Sport | 65-69 | - | - | YB9-B | 12N9-4B-1 |
| 160 | CL160 Scrambler | 66-68 | - | - | YB9-B | 12N9-4B-1 |
| 175 | CA175 Touring (CD175) | 68-69 | - | - | - | B54-6 |
| 175 | CA175 Touring (CD175K3) | 69-70 | - | - | - | 6N12A-2D |
| 175 | CB175 Super Sport | 69-73 | - | - | YB9-B | 12N9-4B-1 |
| 175 | CL175 Scrambler | 68-73 | - | - | YB9-B | 12N9-4B-1 |
| 175 | SL175 Motosport | 70-72 | - | - | - | 12N5-4B |
| 175 | XL175 | 73-78 | - | - | - | 6N6-3B |
| 185 | CM185 T Twinstar | 78-79 | - | - | - | 6N12A-2D |
| 185 | CT185 | 82-86 | - | - | - | 6N4C-1B |
| 185 | XL185 S | 79-83 | - | - | - | 6N4-2A-4 |
| 200 | CB200 T | 74-76 | - | - | YB9-B | 12N9-4B-1 |
| 200 | CBX200 S | 93 | - | - | YB7L-B | - |
| 200 | CL200 Scrambler | 74 | - | - | YB9-B | 12N9-4B-1 |
| 200 | CM200 T | 85-88 | - | YTX12-BS | - | - |
| 200 | CM200 T | 87-89 | - | - | - | 12N9-4B-1 |
| 200 | CM200 T Twinstar | 80 | - | - | - | 6N12A-2D |
| 200 | CM200 T Twinstar | 81-82 | - | - | YB9-B | 12N9-4B-1 |
| 200 | CT200 | 86-89 | - | - | YB9-B | - |
| 200 | GLS200 | 94 | - | - | YB7L-B | - |
| 200 | MTX200 RW | 85 | - | - | YB3L-A | - |
| 200 | TLR200 | 86-87 | - | - | - | 6N2-2A |
| 200 | TLR200 Reflex | 86-87 | - | YTX4L-BS | - | - |
| 200 | TR200 | 86 | - | YTX9-BS | - | - |
| 200 | TR200 | 87 | - | YTX7A-BS | - | - |
| 200 | TR200 Fat Cat | 86 | - | YTX9-BS | - | - |
| 200 | TR200 Fat Cat | 87 | - | YTX7A-BS | - | - |
| 200 | XL200 R/Paris Dakar | 83-84 | - | - | - | 12N9-4B-1 |
| 200 | XL200R | 83-84 | - | - | YB3L-A | - |
| 200 | XR200 | 00- | - | YTX7L-BS | - | - |
| 200 | TA-200 | - | - | YTX4L-BS, YTX5L-BS | - | - |
| 223 | CB223S | 10- | YTZ7S | - | - | - |
| 225 | FTR | 06-08 | - | YTX5L-BS | - | - |
| 225 | FTR | 09- | YTZ7S | - | - | - |
| 230 | CRF230L | 14 | YTZ8V | - | - | - |

| CC | Model | Year | High Performance Maintenance Free | Maintenance Free VRLA | YuMicron | Conventional |
|------------------------|-----------------------------|-------|-----------------------------------|-----------------------|----------|--------------|
| HONDA continued | | | | | | |
| 230 | CRF230L, M | 08-13 | YTZ7S | - | - | - |
| 230 | CRF230F, L (-07) | 03-16 | YTZ7S | YTX5L-BS | - | - |
| 230 | SL230 | - | - | YTX5L-BS | - | - |
| 230 | XR230 | 01- | YTZ7S | - | - | - |
| 250 | CA250 T | 95 | - | YTX7L-BS | - | - |
| 250 | CA250TS | 97 | - | YTX7L-BS | - | - |
| 250 | CA72 Dream Touring (late) | 63-66 | - | - | - | 12N9-3A |
| 250 | CB250 | 91-97 | - | YTX7L-BS | - | - |
| 250 | CB250 F | - | - | YTX7L-BS | - | - |
| 250 | CB250 G, K, N, ND | -82 | - | - | YB12A-A | - |
| 250 | CB250 Nighthawk | 91-09 | YTZ8V | YTX7L-BS | - | - |
| 250 | CB250 RS | 80 | - | - | - | 12N9-4B-1 |
| 250 | CB250 T | 80 | - | - | YB12A-A | - |
| 250 | CB250 T2 Twin | 79 | - | - | YB12A-A | - |
| 250 | CB250FV Hornet | - | - | YTX7L-BS | - | - |
| 250 | CB72 Hawk | 61-66 | - | - | - | 12N9-3A |
| 250 | CBR250R | 11-13 | YTZ8V | YTX7L-BS | - | - |
| 250 | CBR250RR | - | - | YTX7L-BS | - | - |
| 250 | CBX250 Twister | - | - | YTX7L-BS | - | - |
| 250 | CBX250, RS-YA | 85-87 | - | YTX9-BS | - | - |
| 250 | CD250 U | 85-89 | - | YTX9-BS | - | - |
| 250 | CH250 | 87-89 | - | YTX12-BS | - | - |
| 250 | CH250 Elite | 85-90 | - | YTX12-BS | - | - |
| 250 | CJ250 T | - | - | - | YB9-B | - |
| 250 | CL250 S | 82 | - | - | YB9-B | - |
| 250 | CL72 Scrambler | 62-65 | - | - | - | 12N5-4B |
| 250 | CM250, Custom | 82-83 | - | - | YB9-B | - |
| 250 | CM250 C | 82-85 | - | - | YB9-B | - |
| 250 | CMX250 | - | - | YTX7L-BS | - | - |
| 250 | CMX250 C Rebel | 96-16 | YTZ8V | YTX7L-BS | - | - |
| 250 | CMX250 C Rebel | 85-87 | - | - | YB9L-B | - |
| 250 | CMX250 C Rebel, LTD | 85-87 | - | - | YB9L-B | - |
| 250 | CMX250C3 | 01- | - | YTX7L-BS | - | - |
| 250 | CN250 Helix, Fusion Type XX | 86-07 | - | YTX12-BS | - | - |
| 250 | CRF250L | 13- | - | YTX7L-BS | - | - |
| 250 | CRF250M | 13- | - | YTX7L-BS | - | - |
| 250 | CRF250X, XD | 04-16 | YTZ7S | YTX5L-BS | - | - |
| 250 | Faze | 09- | YTZ12S | - | - | - |
| 250 | FES250 Foresight | 01- | YTZ12S | - | - | - |
| 250 | FES250V Foresight | 98-00 | - | YTX12-BS | - | - |
| 250 | Forza Si | 13- | YTZ12S | - | - | - |
| 250 | Forza X, Z | 01- | YTZ12S | - | - | - |
| 250 | MT250 Elsinore | 74-76 | - | - | - | 6N6-3B |
| 250 | NS250S | -01 | YTZ12S | - | - | - |
| 250 | NSR250RR/R | 97 | YTX4L-BS | YT4L-BS | - | - |
| 250 | NSS250 | 10- | YTZ12S | - | - | - |
| 250 | NSS250 Jazz | 01- | YTZ12S | - | - | - |
| 250 | NSS250 Reflex | 01-07 | YTZ12S | - | - | - |
| 250 | NX250 | 88-96 | YTZ8V | YTX7L-BS | - | - |
| 250 | PS250 Big Ruckus | 05-06 | YTZ12S | - | - | - |
| 250 | SM250 | 09-12 | YTZ12S | - | - | - |
| 250 | VT250 | 90-95 | - | YTX7L-BS | - | - |
| 250 | VT250C V-Twin Magna | - | - | YTX7L-BS | - | - |

Can't find your vehicle listed?
Visit www.yuasa.com for our latest application data

| CC | Model | Year | High Performance Maintenance Free | Maintenance Free VRLA | YuMicron | Conventional |
|------------------------|---------------------------|---------|-----------------------------------|-----------------------|----------|--------------|
| HONDA continued | | | | | | |
| 250 | VT250CS | -97 | - | YTX7L-BS | - | - |
| 250 | VTR-F | 13-14 | YTZ7S | - | - | - |
| 250 | VTR250, RD | 10-13 | YTZ7S | - | - | - |
| 250 | VTR250 | 14- | YTZ7S | - | - | - |
| 250 | VTR250 Type LD | 14- | YTZ7S | - | - | - |
| 250 | VTR250 Interceptor VTR | 88-90 | - | - | YB9-B | - |
| 250 | XL250 | 72-76 | - | - | - | 6N6-3B |
| 250 | XL250 R | 84-87 | - | - | YB3L-A | - |
| 250 | XL250 RC | 82-83 | - | - | YB3L-A | - |
| 250 | XL250R | 82-87 | - | - | YB3L-A | - |
| 250 | XL250S | 78-81 | - | - | - | 6N4-2A-4 |
| 250 | XR250 | - | - | YTX5L-BS | - | - |
| 250 | XR250 L, R | 91-98 | - | YTX4L-BS | - | - |
| 250 | XR250 Tornado | - | - | YTX7L-BS | - | - |
| 300 | CB300F | 15-16 | YTZ8V | YTX7L-BS | - | - |
| 300 | CBR300R | 15-16 | YTZ8V | YTX7L-BS | - | - |
| 300 | NSS300 Forza | 14-16 | YTZ12S | - | - | - |
| 300 | SH300 | 10- | YTZ12S | - | - | - |
| 305 | CA77 Dream Touring (late) | 63-69 | - | - | - | 12N9-3A |
| 305 | CB77 Super Hawk | 61-68 | - | - | - | 12N9-3A |
| 305 | CL77 Scrambler | 65-68 | - | - | - | 12N5-4B |
| 350 | CB350 S | 86 | - | - | YB12A-B | - |
| 350 | CB350 Super Sport Four | 68-74 | - | - | YB12A-A | 12N12A-4A-1 |
| 350 | CB350F, CB350K | - | - | - | YB12A-A | - |
| 350 | CL350 Scrambler | 68-73 | - | - | YB12A-A | 12N12A-4A-1 |
| 350 | SL350 Motosport | 69-70 | - | - | YB12A-A | 12N12A-4A-1 |
| 350 | SL350 Motosport | 70-73 | - | - | - | 12N5-4B |
| 350 | XL350 | 74-78 | - | - | - | 6N6-3B |
| 350 | XL350R, XR350R | 84-87 | - | - | YB3L-A | - |
| 360 | CB360 G, T, Scrambler 360 | 74-76 | - | - | YB12A-A | 12N12A-4A-1 |
| 360 | CJ360T | 76-77 | - | - | YB9-B | 12N9-4B-1 |
| 360 | CL360 Scrambler | 74-75 | - | - | YB12A-A | 12N12A-4A-1 |
| 400 | 400X | 13- | YTZ10S | - | - | - |
| 400 | CB400 Super BoldÖor | 05- | YTZ10S | - | - | - |
| 400 | CB400 F | - | YTZ10S | - | - | - |
| 400 | CB400 N | 79 | - | - | YB12A-A | - |
| 400 | CB400 SS | -03 | - | YTR4A-BS | - | - |
| 400 | CB400 Super Four | 01- | YTZ10S | - | - | - |
| 400 | CB400A | 78 | - | - | YB12A-A | - |
| 400 | CB400D/SD | #VALUE! | YTZ10S | - | - | - |
| 400 | CB400F CB-1 | 89-90 | - | YTX9-BS | - | - |
| 400 | CB400F Super Sport | 75-77 | - | - | YB12A-A | 12N12A-4A-1 |
| 400 | CB400F/F II | 75 | - | - | - | 12N12A-4A-1 |
| 400 | CB400SF/SB | 10-14 | YTZ10S | - | - | - |
| 400 | CB400T Hawk | 80-81 | - | - | YB12A-A | - |
| 400 | CB400T Hawk I | 78-79 | - | - | YB9-B | 12N9-4B-1 |
| 400 | CB400T Hawk II | 78-79 | - | - | YB12A-A | - |
| 400 | CBR400R | 13- | YTZ10S | - | - | - |
| 400 | CBR400RRR | 86-89 | - | YTX9-BS | - | - |
| 400 | CBX400F/F II | - | - | - | YB12A-A | - |
| 400 | CM400A Hondamatic | 79-81 | - | - | YB12A-A | - |
| 400 | CM400C Custom | 81 | - | - | YB12A-A | - |
| 400 | CM400E/T | 79-82 | - | - | YB12A-A | - |

| CC | Model | Year | High Performance Maintenance Free | Maintenance Free VRLA | YuMicron | Conventional |
|------------------------|-------------------------|-------|-----------------------------------|-----------------------|-----------|--------------|
| HONDA continued | | | | | | |
| 400 | CX400 C | 81-83 | - | - | YB14L-A2 | - |
| 400 | NS400 R/Raiden | - | - | YTX5L-BS | - | - |
| 400 | NS400R | 85 | YTX5L-BS | YT5L-BS | - | - |
| 400 | NV400 DC Shadow | 01- | - | YTX14-BS | - | - |
| 400 | NV400 DC Shadow Skasher | 01- | YTZ10S | - | - | - |
| 400 | NV400 Steed | 01- | YTZ10S | - | - | - |
| 400 | NV400C | 95 | - | YTX9-BS | - | - |
| 400 | RVF400 (NC35) | - | - | YTX7A-BS | - | - |
| 400 | Shadow Classic 400 | 08- | YTZ10S | - | - | - |
| 400 | Shadow Custom 400 | 08- | YTZ10S | - | - | - |
| 400 | Silver Wing 400 | 01- | YTZ12S | - | - | - |
| 400 | Silver Wing GT400 | 09- | YTZ12S | - | - | - |
| 400 | VF400 F | 83 | - | - | YB12A-A | - |
| 400 | VFR400R III (NC30) | 90-91 | - | YTX7A-BS | - | - |
| 400 | VT400S | 10- | YTZ10S | - | - | - |
| 450 | CB450, SS | 67-74 | - | - | YB12A-A | 12N12A-4A-1 |
| 450 | CB450K/K7 | - | - | - | - | 12N12A-4A-1 |
| 450 | CB450N | 85 | - | - | YB12AL-A2 | - |
| 450 | CB450S | 88 | YTX14AH-BS | - | YB14-B2 | - |
| 450 | CB450S | 86-87 | - | - | YB12A-B | - |
| 450 | CB450SC | 82-86 | - | - | YB12A-A | - |
| 450 | CB450SC Nighthawk, T | 82-86 | - | - | YB12A-A | - |
| 450 | CB450SC Nighthawk/S | 85-86 | - | - | YB12A-A | - |
| 450 | CB450T Hawk | 82 | - | - | YB12A-A | - |
| 450 | CL450 Scrambler | 67-74 | - | - | YB12A-A | 12N12A-4A-1 |
| 450 | CM450A Hondamatic, E | 82-83 | - | - | YB12A-A | - |
| 450 | CM450C Custom, E | 82-83 | - | - | YB12A-A | - |
| 450 | CMX450C, Rebel | 86-88 | - | - | YB12A-A | - |
| 450 | CRF450X, XD | 05-16 | YTZ7S | - | - | - |
| 500 | CB500 | 04- | YTZ10S | - | - | - |
| 500 | CB500F | 13-16 | YTZ10S | - | - | - |
| 500 | CB500R | 13- | YTZ10S | - | - | - |
| 500 | CB500X | 13-16 | YTZ10S | - | - | - |
| 500 | CB500 Four, Twin | 71-76 | - | - | YB12A-A | 12N12A-4A-1 |
| 500 | CB500K-1/K-3 | - | - | - | - | 12N12A-4A-1 |
| 500 | CB500S | 98-99 | - | YTX9-BS | - | - |
| 500 | CB500T Twin, Four | 75-76 | - | - | - | 12N12A-4A-1 |
| 500 | CBF500 | 04- | YTZ10S | - | - | - |
| 500 | CBR500F | 87-89 | - | YTX9-BS | - | - |
| 500 | CBR500R | 13-16 | YTZ10S | - | - | - |
| 500 | CX500 Custom | - | YTX14AHL-BS | - | - | - |
| 500 | CX500, C, D, E, T, TC | 78-82 | YTX14AHL-BS | - | YB14L-A2 | - |
| 500 | FT500 Ascot | 82-83 | YTX14AHL-BS | - | YB14L-A2 | - |
| 500 | GB500 | 89-90 | - | - | YB12A-B | - |
| 500 | GL500 I Intercept | 81-82 | - | - | YB14L-A2 | - |
| 500 | GL500, I Silver Wing | 81-82 | YTX14AHL-BS | - | YB14L-A2 | - |
| 500 | NX500 | 88-95 | - | YTX9-BS | - | - |
| 500 | VF500C V30 Magna | 84-85 | - | - | YB12A-A | - |
| 500 | VF500F Interceptor, FII | 84-86 | - | - | YB12A-A | - |
| 500 | VT500C Shadow | 83-86 | - | - | YB12A-A | - |
| 500 | VT500E | 83-85 | - | - | YB12A-A | - |
| 500 | VT500FT Ascot | 83-84 | - | - | YB12A-A | - |
| 500 | XBR500 | 85-86 | - | - | YB12A-B | - |

World number one for motorcycle batteries

| CC | Model | Year | High Performance Maintenance Free | Maintenance Free VRLA | YuMicron | Conventional |
|------------------------|-------------------------------|-------|-----------------------------------|-----------------------|-----------|--------------|
| HONDA continued | | | | | | |
| 500 | XBR500, S | 87-88 | YTX14AH-BS | - | YB14-B2 | - |
| 500 | XL500R | 82-87 | - | - | YB3L-A | - |
| 500 | XL500S | 79-81 | - | - | - | 6N4-2A-4 |
| 550 | CB550 | 83-84 | - | - | YB12AL-A2 | - |
| 550 | CB550 F | 74-77 | - | - | - | 12N12A-4A-1 |
| 550 | CB550 Four, K, SS | 74-78 | - | - | YB12A-A | 12N12A-4A-1 |
| 550 | CB550 K2/K4 | 77-78 | - | - | - | 12N12A-4A-1 |
| 550 | CB550SC Nighthawk | 83-85 | - | - | YB12AL-A2 | - |
| 550 | CBX550F, F II | 82-83 | - | - | YB12A-A | - |
| 582 | FSC600 Silver Wing | 02-07 | YTZ12S | - | - | - |
| 600 | CB600 F, Hornet, ABS | 01-07 | - | YTX7L-BS | - | - |
| 600 | CB600 SF | 02 | YTZ7S | YTX7L-BS | - | - |
| 600 | CB600F | 07- | YTZ10S | - | - | - |
| 600 | CB600F (599) | 04-06 | - | YTX7L-BS | - | - |
| 600 | CBF600 | 07- | YTZ10S | - | - | - |
| 600 | CBF600N, NA | 03-07 | - | YTX7L-BS | - | - |
| 600 | CBF600S, SA | 03-07 | - | YTX7L-BS | - | - |
| 600 | CBR600 | 87-00 | - | YTX9-BS | - | - |
| 600 | CBR600 F | - | YTZ10S | - | - | - |
| 600 | CBR600 F, F II, F III, SE | 95-99 | - | YTX9-BS | - | - |
| 600 | CBR600 F4i, 600RR | 01-16 | YTZ10S | - | - | - |
| 600 | CBR600RR | 09- | YTZ10S | - | - | - |
| 600 | CBR600F/SP | 01- | YTZ10S | - | - | - |
| 600 | CBR600F/SP | 87-00 | - | YTX9-BS | - | - |
| 600 | CBR600FS/SX | 01- | YTZ10S | - | - | - |
| 600 | CBX600E | 83 | - | - | YB12AL-A2 | - |
| 600 | FSC600 | 02-13 | YTZ12S | - | - | - |
| 600 | FJS600, Sliver Wing | 01- | YTZ12S | - | - | - |
| 600 | FJS600DB/AB | 10- | YTZ12S | - | - | - |
| 600 | Hornet 600 | 98 | - | YTX7L-BS | - | - |
| 600 | NTV600 | 88-92 | - | YTX9-BS | - | - |
| 600 | NV600C | 89-94 | - | YTX9-BS | - | - |
| 600 | Shadow 600 | - | - | YTX9-BS | - | - |
| 600 | Silver Wing | 88-00 | YTX14AH-BS | - | YB14-B2 | - |
| 600 | Silver Wing GT 600 | 09- | YTZ12S | - | - | - |
| 600 | VT600 C Shadow | 88-99 | - | YTX9-BS | - | - |
| 600 | VT600 C, CD Shadow Deluxe | 04-07 | YTZ10S | - | - | - |
| 600 | VT600C, CD Shadow Deluxe, VLX | 88-03 | - | YTX9-BS | - | - |
| 600 | VT600C | 88-97 | - | YTX9-BS | - | - |
| 600 | XL600 Transport | -87 | - | - | YB12A-B | - |
| 600 | XL600LM | 85-91 | - | - | YB14-A2 | - |
| 600 | XL600R | 83-87 | - | - | YB3L-A | - |
| 600 | XL600V | 87-93 | YTX14AH-BS | - | YB14-B2 | - |
| 600 | XL600V | 94-00 | - | - | YB12A-B | - |
| 600 | XL600V Transalp | 89-90 | - | - | YB12A-B | - |
| 600 | XL600V Transport | 95-97 | - | - | YB12A-B | - |
| 650 | CB650 | 79-82 | - | - | YB12A-A | - |
| 650 | CB650 C Custom | 80-81 | - | - | YB12A-A | - |
| 650 | CB650 SC Custom | 82 | - | - | YB12A-A | - |
| 650 | CB650 SC Nighthawk | 83-85 | - | - | YB12AL-A2 | - |
| 650 | CB650, Custom | 79-82 | - | - | YB12A-A | - |
| 650 | CB650SC Nighthawk | 82 | - | - | YB12A-A | - |
| 650 | CB650SC Nighthawk | 83-85 | - | - | YB12AL-A2 | - |

| CC | Model | Year | High Performance Maintenance Free | Maintenance Free VRLA | YuMicron | Conventional |
|------------------------|-------------------------------|-------|-----------------------------------|-----------------------|------------|--------------|
| HONDA continued | | | | | | |
| 650 | CB650F | 14- | YTZ10S | - | - | - |
| 650 | CB650Z | 79 | - | - | YB12A-A | - |
| 650 | CBR650F | 14- | YTZ10S | - | - | - |
| 650 | CBX650E Nighthawk | 84 | - | - | YB14L-A2 | - |
| 650 | CBX650E Nighthawk | 82-83 | - | - | YB12AL-A2 | - |
| 650 | CX650 Euro,Turbo | 83 | - | - | YB14L-A2 | - |
| 650 | CX650C Custom | 83 | YTX14AH-BS | - | YB14-A2 | - |
| 650 | CX650T Turbo | 83 | YTX14AHL-BS | - | YB14L-A2 | - |
| 650 | FX650 | -01 | - | YTX9-BS | - | - |
| 650 | GL650 I Interstate | 83 | - | - | YB14L-A2 | - |
| 650 | GL650 Silver Wing | 83 | - | - | YB14L-A2 | - |
| 650 | GL650I Silver Wing Interstate | 83 | YTX14AHL-BS | - | YB14L-A2 | - |
| 650 | NT650 Hawk GT | 88-91 | - | YTX9-BS | - | - |
| 650 | NT650V Deauville | 98-05 | YTZ10S | - | - | - |
| 650 | NTV650 Revere | 88-97 | - | YTX9-BS | - | - |
| 650 | NX650 | 88-89 | - | YTX9-BS | - | - |
| 650 | NX650 Dominator | 88-97 | - | YTX9-BS | - | - |
| 650 | SLR650 | 97-98 | - | YTX9-BS | - | - |
| 650 | Vigor 650 | 99 | - | YTX9-BS | - | - |
| 650 | XL650, V, Transalp | 01- | YTZ12S | - | - | - |
| 650 | XR650L | 93-16 | - | YTX9-BS | - | - |
| 650 | XRV650 | 88-89 | YTX14AH-BS | - | YB14-B2 | - |
| 680 | DN-01 | 09-13 | YTZ14S | - | - | - |
| 700 | CB700SC | 84-86 | - | - | YB14L-A2 | - |
| 700 | CB700SC Nighthawk ÔS | 87 | - | - | YB14L-A1 | - |
| 700 | CTX700 | 14- | YTZ12S | - | - | - |
| 700 | CTX700C,N | 13- | YTZ12S | - | - | - |
| 700 | Integra | 12- | YTZ12S | - | - | - |
| 700 | Integra | 16- | YTZ14S | - | - | - |
| 700 | NC700J | 15-16 | YTZ12S | - | - | - |
| 700 | NC700 | - | YTZ12S | - | - | - |
| 700 | NC700S, X, XD | 12-16 | YTZ12S | - | - | - |
| 700 | NC700SE | 14- | YTZ14S | - | - | - |
| 700 | NT700V Deauville | 06-15 | YTZ14S | - | - | - |
| 700 | VF700C Magna | 87 | - | - | YB12A-A | - |
| 700 | VF700C Magna | 84-86 | YTX14AH-BS | - | YB14-A2 | - |
| 700 | VF700F Interceptor | 84-85 | YTX14AH-BS | - | YB14-A2 | - |
| 700 | VF700S Sabre | 84-85 | YTX14AHL-BS | - | YB14L-A2 | - |
| 700 | VFR700 F | 86 | - | - | YB12A-B | - |
| 700 | VFR700 Interceptor | 86-87 | - | - | YB12A-B | - |
| 700 | VFR700F, F II Interceptor | 86-87 | - | - | YB12A-B | - |
| 700 | VT700C Shadow | 84-85 | - | - | HYB16A-AB | - |
| 700 | VT700C Shadow | 86-87 | YTX14AH-BS | - | YB14-B2 | - |
| 700 | XL700V | 11- | YTZ14S | - | - | - |
| 745 | NM4-01, 02 | 15- | YTZ12S | - | - | - |
| 745 | NM4-01, 02 | 16- | YTZ14S | - | - | - |
| 750 | Africa Twin | 93 | YTX14AH-BS | - | YB14-B2 | - |
| 750 | CB750 F II | 91- | - | - | YB14-A2 | - |
| 750 | CB750 KZ | 80 | - | - | YB14L-A2 | - |
| 750 | CB750 Nighthawk | 82-83 | - | - | YB14L-A2 | - |
| 750 | CB750 Nighthawk | 91-03 | YTX14AH-BS | - | YB14-A2 | - |
| 750 | CB750, C, F, F2 | -88 | - | - | YB14L-A2 | - |
| 750 | CB750A | 76-78 | - | - | Y50-N18L-A | - |

Can't find your vehicle listed?
Visit www.yuasa.com for our latest application data

| CC | Model | Year | High Performance Maintenance Free | Maintenance Free VRLA | YuMicron | Conventional |
|------------------------|---|-------|-----------------------------------|-----------------------|---------------|--------------|
| HONDA continued | | | | | | |
| 750 | CB750A Hondamatic | 76-78 | YTX24HL-BS | - | Y50-N18L-A-CX | Y50-N18L-A |
| 750 | CB750C Custom | 80-82 | YTX14AHL-BS | - | YB14L-A2 | - |
| 750 | CB750F Super Sport | 75-82 | YTX14AHL-BS | - | YB14L-A2 | - |
| 750 | CB750FA | 93-95 | - | - | YB14-A2 | - |
| 750 | CB750K | -82 | - | - | YB14L-A2 | - |
| 750 | CB750K Four | 69-82 | YTX14AHL-BS | - | YB14L-A2 | 12N14-3A |
| 750 | CB750K Limited Edition | 79 | YTX14AHL-BS | - | YB14L-A2 | - |
| 750 | CB750SC | 84-85 | - | - | YB14L-A2 | - |
| 750 | CB750SC | 91-92 | - | - | YB14-A2 | - |
| 750 | CB750SC Nighthawk | 82-83 | YTX14AHL-BS | - | YB14L-A2 | - |
| 750 | CBX750F | 84-86 | - | - | YB14-A2 | - |
| 750 | CBX750F II | 86 | - | - | YB14-A2 | - |
| 750 | CBX750P2 | 84- | - | - | YB14L-A1 | - |
| 750 | CR750 45 | - | - | YTX9-BS | - | - |
| 750 | NC750J | 14- | YTZ12S | - | - | - |
| 750 | NC750L | - | YTZ12S | - | - | - |
| 750 | NC750S | - | YTZ14S | - | - | - |
| 750 | NC750X | - | YTZ14S | - | - | - |
| 750 | NR | 92 | - | YTX12-BS | - | - |
| 750 | NV750, Shadow | 97-98 | YTZ14S | YTX14-BS | - | - |
| 750 | NV750 Shadow Slasher | 01- | YTZ14S | - | - | - |
| 750 | RVF (RC45) | - | - | YTX14-BS | - | - |
| 750 | RVF750R (RC45) | 94-95 | - | YTX9-BS | - | - |
| 750 | NC750SE,XE | 14- | YTZ14S | - | - | - |
| 750 | Shadow Phantom | - | YTZ14S | - | - | - |
| 750 | VF750C | 95-97 | - | YTX12-BS | - | - |
| 750 | VF750C Magna | 82-86 | - | - | YB14-A2 | - |
| 750 | VF750C Magna | 87-92 | - | - | YB12A-A | - |
| 750 | VF750C Magna | 93-94 | - | YTX9-BS | - | - |
| 750 | VF750C V45 Magna | 88 | - | - | YB12A-A | - |
| 750 | VF750C V45 Magna | 82-83 | YTX14AH-BS | - | YB14-A2 | - |
| 750 | VF750C, C2, D Magna | 94-03 | - | YTX12-BS | - | - |
| 750 | VF750F V45 Interceptor | 83-84 | YTX14AH-BS | - | YB14-A2 | - |
| 750 | VF750S V45 Sabre | 82-83 | - | - | YB14L-A2 (s) | - |
| 750 | VFR750F | 87-89 | - | YTX12-BS | - | - |
| 750 | VFR750F | 90-97 | - | YTX12-BS | - | - |
| 750 | VFR750F Interceptor | 86 | - | - | YB12A-B | - |
| 750 | VFR750R (RC30) | 88-90 | - | YTX9-BS | - | - |
| 750 | VT750 | 10-14 | YTZ14S | - | - | - |
| 750 | VT750 C | - | YTZ14S | - | - | - |
| 750 | VT750C Shadow | 83 | - | - | HYB16A-AB | - |
| 750 | VT750C Shadow | 98-00 | - | YTX14-BS | - | - |
| 750 | VT750C, CA, C2 | 04-08 | YTZ12S | - | - | - |
| 750 | VT750CD, CD2 Shadow Deluxe | 98-02 | - | YTX14-BS | - | - |
| 750 | VT750CDA, B, C, D Shadow, A.C.E. Deluxe | 02-03 | - | YTX14-BS | - | - |
| 750 | VT750DC, A, B Shadow Spirit | 01-07 | YTZ14S | - | - | - |
| 750 | VT750RS, C2B | 10-13 | YTZ14S | - | - | - |
| 750 | VT750S | 10- | YTZ14S | - | - | - |
| 750 | XLV750R | 83 | - | - | YB14-A2 | - |
| 750 | XRV750 African Twin | 90-92 | YTX14AH-BS | - | YB14-B2 | - |
| 750 | XRV750 African Twin | - | - | YTX14-BS | - | - |
| 800 | PC800 Pacific Coast | 89-98 | - | YTX12-BS | - | - |
| 800 | VFR800 | 01- | YTZ12S | - | - | - |

(s) YB14L-A2 - When ordering this battery specify sensor



| CC | Model | Year | High Performance Maintenance Free | Maintenance Free VRLA | YuMicron | Conventional |
|------------------------|----------------------------|-------|-----------------------------------|-----------------------|---------------|--------------|
| HONDA continued | | | | | | |
| 800 | VFR800, A Interceptor, ABS | 02-12 | YTZ12S | - | - | - |
| 800 | VFR800F | 14- | YTZ12S | - | - | - |
| 800 | VFR800F I | 02 | YTZ12S | YTX12-BS | - | - |
| 800 | VFR800FI Interceptor | 98-01 | - | YTX12-BS | - | - |
| 800 | VFR800P | 01- | YTZ14S | - | - | - |
| 800 | VFR800X | 13- | YTZ12S | - | - | - |
| 800 | VFR800XF | 14- | YTZ12S | - | - | - |
| 800 | VT800C Shadow | 88 | YTX14AH-BS | - | YB14-B2 | - |
| 900 | CB900 FZ80 | - | - | - | YB14L-A2 | - |
| 900 | CB900C, F | 80-82 | YTX14AHL-BS | - | YB14L-A2 | - |
| 900 | CB900F Bolldr | 79-83 | - | - | YB14L-A2 | - |
| 900 | CB900F Hornet | 02- | YTZ10S | - | - | - |
| 900 | CBR900RR FireBlade | 00-02 | YTZ10S | - | - | - |
| 900 | CBR900R, RR FireBlade | 92-99 | - | YTX9-BS | - | - |
| 900 | CBR929R | 00- | YTZ10S | - | - | - |
| 900 | CBR954RR | 01- | YTZ10S | - | - | - |
| 919 | CB900F (919) | 02-06 | YTZ10S | - | - | - |
| 929 | CBR929RR, RE | 00-01 | YTZ10S | - | - | - |
| 954 | CBR954RR | 02-03 | YTZ10S | - | - | - |
| 1000 | CB1000 | 94-95 | - | YTX12-BS | - | - |
| 1000 | CB1000C Custom | 83 | YTX14AHL-BS | - | YB14L-A2 | - |
| 1000 | CB1000F | 93-96 | - | YTX12-BS | - | - |
| 1000 | CB1000FT | 93-96 | - | YTX12-BS | - | - |
| 1000 | CB1000R | 09-16 | YTZ10S | - | - | - |
| 1000 | CBF1000F | 09- | YTZ10S | - | - | - |
| 1000 | CBR1000F Hurricane | 87-96 | YTX14AHL-BS | - | YB14L-B2 | - |
| 1000 | CBR1000RA (ABS) | 08-16 | YTZ10S | - | - | - |
| 1000 | CBR1000RR | 08- | YTZ7S | - | - | - |
| 1000 | CBR1000RR (ABS)/RA | 10- | YTZ10S | - | - | - |
| 1000 | CBR1000RR Fireblade | 04-07 | YTZ10S | - | - | - |
| 1000 | CBR1000RR Fireblade | 07- | YTZ7S | - | - | - |
| 1000 | CBX1000 | 79 | - | - | YB18L-A | - |
| 1000 | CBX1000 (Opt) | 81 | - | - | YB18L-A | - |
| 1000 | CBX1000 Super Sport | 79-82 | YTX20HL-BS | YTX20L-BS | YB18L-A | - |
| 1000 | CBX1000 Super Sport (Opt) | 82 | YTX24HL-BS | - | Y50-N18L-A-CX | Y50-N18L-A |
| 1000 | CRF1000L Africa Twin | 16- | YTZ14S | - | - | - |
| 1000 | GL1000, LTD, K Gold Wing | 75-79 | YTX24HL-BS | - | Y50-N18L-A-CX | Y50-N18L-A |
| 1000 | RC213V-S | 16- | YTZ7S | YTX5L-BS | - | - |
| 1000 | RVT1000R RC51 | 00-06 | YTZ12S | - | - | - |
| 1000 | VF1000F Bolldr | 85 | - | - | YB16B-A | - |
| 1000 | VF1000F Interceptor | 84-85 | - | - | YB16B-A | - |
| 1000 | VF1000R, F | 84-86 | - | - | YB16B-A | - |
| 1000 | VTR1000 F | 01- | YTZ12S | - | - | - |
| 1000 | VTR1000 F | 97-00 | - | YTX12-BS | - | - |
| 1000 | VTR1000F Super Hawk | 01-05 | YTZ12S | - | - | - |
| 1000 | VTR1000F Super Hawk | 97-00 | - | YTX12-BS | - | - |
| 1000 | VTR1000SP | 00- | YTZ12S | - | - | - |
| 1000 | VTR1000SP II | 04 | - | YTX12-BS | - | - |
| 1000 | XL1000V Varadero | 97-13 | YTX20CH-BS | - | - | - |
| 1000 | XL1000V | 10-12 | - | YTX20CH-BS | - | - |
| 1100 | CB1100, C, AC | 10- | YTZ14S | - | - | - |
| 1100 | CB1100 EX | 15- | YTZ14S | - | - | - |
| 1100 | CB1100F Bolldr, R, R II | 81-83 | - | - | YB14L-A2 | - |

World number one for motorcycle batteries

| CC | Model | Year | High Performance Maintenance Free | Maintenance Free VRLA | YuMicron | Conventional |
|------------------------|--|-------|-----------------------------------|-----------------------|---------------|--------------|
| HONDA continued | | | | | | |
| 1100 | CB1100F Super Sport | 83 | YTX14AHL-BS | - | YB14L-A2 | - |
| 1100 | CB1100SF | 00-01 | - | YTX12-BS | - | - |
| 1100 | CBR1100 XX | 01- | YTZ12S | - | - | - |
| 1100 | CBR1100 XX Blackbird | 97-00 | - | YTX12-BS | - | - |
| 1100 | GL1100 Gold Wing | 80-83 | YTX24HL-BS | - | Y50-N18L-A-CX | Y50-N18L-A |
| 1100 | GL1100 I Interstate | 80-83 | - | - | Y50-N18L-A | - |
| 1100 | GL1100, D Gold Wing | 80-83 | - | - | Y50-N18L-A | - |
| 1100 | GL1100A Aspencade | 80-83 | - | - | Y50-N18L-A | - |
| 1100 | ST1100, A Police, Pan Eur. | 90- | - | YTX14-BS | - | - |
| 1100 | ST1100, ABS-TCS, 1100A | 91-02 | YTX14H-BS | YTX14-BS | - | - |
| 1100 | VF1100C V65 Magna | 83-86 | YTX20H-BS | YTX20-BS | YB18-A | - |
| 1100 | VF1100S V65 Sabre | 84-85 | YTX20HL-BS | YTX20L-BS | YB18L-A | - |
| 1100 | VT1100 C II | 95-00 | - | - | HYB16A-AB | - |
| 1100 | VT1100 C, C II Shadow | 85-96 | - | - | HYB16A-AB | - |
| 1100 | VT1100 C2 Shadow Sabre | 00-04 | - | YTX14-BS | - | - |
| 1100 | VT1100C Shadow Spirit | 85-97 | YTZ14S | - | HYB16A-AB | - |
| 1100 | VT1100C, C3, T Shadow (Spirit, Aero, A. C. E. Tourer) | 98-00 | YTZ14S | - | - | HYB16A-AB |
| 1100 | VT1100C, C3, T Shadow (Spirit, Aero, A. C. E. Tourer) | 01-07 | YTX14AH-BS | YTX14-BS | - | - |
| 1100 | VT1100C2 Shadow A. C. E. | 95-99 | YTZ14S | - | HYB16A-AB | - |
| 1100 | VT1100C2 Shadow Sabre | 00-07 | - | YTX14-BS | - | - |
| 1200 | GL1200 Aspencade | 84-87 | - | - | Y50-N18L-A | - |
| 1200 | GL1200 Gold Wing | 84-87 | YTX24HL-BS | - | Y50-N18L-A-CX | Y50-N18L-A |
| 1200 | GL1200 I/A | 86-87 | - | - | Y50-N18L-A | - |
| 1200 | GL1200 SEI | 86 | - | - | Y50-N18L-A | - |
| 1200 | VFR1200F, FD, X | 10- | YTZ14S | - | - | - |
| 1200 | CB1300A/SA | - | YTZ14S | - | - | - |
| 1200 | VR1200X | 14- | YTZ14S | - | - | - |
| 1300 | CB1300 Super Four | 01-13 | YTZ14S | - | - | - |
| 1300 | CB1300 Super Four / Super Bol DÖor | 14- | YTZ14S | - | - | - |
| 1300 | CB1300DC X4 Type LD | 01- | - | YTX14-BS | - | - |
| 1300 | CTX1300 | 14- | YTZ14S | - | - | - |
| 1300 | Pan-European | 4 | YTZ14S | - | - | - |
| 1300 | ST1300 | 09-14 | YTZ14S | - | - | - |
| 1300 | ST1300, A, P | 03-12 | YTZ14S | - | - | - |
| 1300 | ST1300, A, AP | 14- | YTZ14S | - | - | - |
| 1300 | STX1300 | 03-12 | YTZ14S | - | - | - |
| 1300 | VT1300CS, CR, CT, CXA FURY | 09-16 | YTZ14S | - | - | - |
| 1300 | VT1300 | 14- | YTZ14S | - | - | - |
| 1300 | VTX1300C, S Retro | 03-12 | - | YTX14-BS | - | - |
| 1300 | VT1300CX | 15- | YTZ14S | - | - | - |
| 1300 | VTX1300R, S, C | 5 | - | YTX14-BS | - | - |
| 1300 | X4 | - | - | YTX14-BS | - | - |
| 1500 | GL1500 A Aspencade | 95-97 | - | - | Y50-N18L-A3 | - |
| 1500 | GL1500 C (F6C) | - | - | YTX14-BS | - | - |
| 1500 | GL1500 Gold Wing | 88-00 | YTX24HL-BS | - | Y50-N18L-A3 | - |
| 1500 | GL1500 I Gold Wing Inter. | 91-96 | - | - | Y50-N18L-A3 | - |
| 1500 | GL1500 SE Gold Wing SE | 91-00 | - | - | Y50-N18L-A3 | - |
| 1500 | GL1500 Valkyrie | 97-03 | YTX14H-BS | YTX14-BS | - | - |
| 1800 | GL1800BF | 14- | GYZ20L | - | - | - |
| 1800 | GL1800C, CF | 14- | GYZ20L | - | - | - |
| 1800 | GL1800 Gold Wing | 01-08 | GYZ20L | YTX20L-BS | - | - |
| 1800 | GL1800 Gold Wing | 09-13 | GYZ20L | - | - | - |

| CC | Model | Year | High Performance Maintenance Free | Maintenance Free VRLA | YuMicron | Conventional |
|------------------------|---|-------|-----------------------------------|-----------------------|------------|--------------|
| HONDA continued | | | | | | |
| 1800 | GL1800 Gold Wing F6B | 09- | GYZ20L | - | - | - |
| 1800 | GL1800A Gold Wing | 01-08 | GYZ20L | YTX20L-BS | - | - |
| 1800 | GL1800, D | 08- | GYZ20L | - | - | - |
| 1800 | GL1800F | 14- | GYZ20L | - | - | - |
| 1800 | GL1800F6C | 15- | GYZ20L | - | - | - |
| 1800 | NRX1800 Valkyrie Rune | 04-05 | GYZ20L | YTX20L-BS | - | - |
| 1800 | VTX1800C, F, N, R Retro, S | 02-11 | YTX20HL-BS | YTX20L-BS | - | - |
| HUSABERG | | | | | | |
| 50 | All Electric Start Models | 01-02 | - | YTX5L-BS | - | - |
| 50 | All Electric Start Models | 97-00 | - | YTX9-BS | - | - |
| 450 | FE450e/6 | - | YTZ7S | - | - | - |
| 450 | FS450e/6 | - | YTZ7S | - | - | - |
| 550 | FE550e/6 | - | YTZ7S | - | - | - |
| 650 | FE650e/6 | - | YTZ7S | - | - | - |
| 650 | FS650e/6 | - | YTZ7S | - | - | - |
| HUSQUARNA | | | | | | |
| 125 | 125GT, GTL | - | - | - | - | 6N11A-1B |
| 125 | GT125SP | - | - | - | - | 12N5.5-3B |
| 250 | TE-SM | 05 | YTZ7S | - | - | - |
| 350 | Scrambler Elettronica | - | - | - | - | 12N5.5-3B |
| 450 | TE-SM | 05 | YTZ7S | - | - | - |
| 510 | TE-SM | 05 | YTZ7S | - | - | - |
| 750 | Aviamento, GT | - | - | - | 53030 | - |
| 800 | S, SS | - | - | - | Y60-N24L-A | - |
| 900 | GT | - | - | - | Y60-N24L-A | - |
| 900 | NUDA900 | 12- | - | YTX14-BS | - | - |
| 900 | NUDA900R | 12- | - | YTX14-BS | - | - |
| 1100 | Grand Prix | - | - | - | Y60-N24L-A | - |
| HYOSUNG MOTORS | | | | | | |
| 50 | SB Super Cab, SD50 Sense | All | - | YTX4L-BS | - | - |
| 50 | SF50 Prima, Rally, Sense | All | - | YTX4L-BS | - | - |
| 100 | EZ100 | All | YTZ7S | YTX5L-BS | - | - |
| 125 | XR125 | All | - | YTX7A-BS | - | - |
| 250 | NS3-250 | 09-16 | - | YTX9-BS | - | - |
| INDIAN | | | | | | |
| 999 | Scout Sixty | 16 | YTX14AH (WC) | - | - | - |
| 1133 | Scout | 15-16 | YTX14AH (WC) | - | - | - |
| 1442 | Scout, Spirit | 02-03 | YTX20H-BS | YTX20-BS | - | - |
| | All Models | 99-01 | YTX20H-BS | YTX20-BS | - | - |
| 1638 | Chief | 02-03 | YTX24HL-BS | - | - | - |
| 1720 | Chief Classic, Vintage, Dark Horse | 12-13 | YTX24HL (WC) | - | - | - |
| | All Models | 09-11 | YTX20H-BS | - | - | - |
| 1819 | Chief Classic, Vintage, Chieftain, Roadmaster | 14-16 | YTX20HL (WC) | - | - | - |
| 1819 | Chief Dark Horse | 16 | YTX20HL (WC) | - | - | - |
| INNOCENTI | | | | | | |
| 125 | Lambretta LI/DL | - | - | - | 6N11A-3A | - |
| 150 | Lambretta LI/DL | - | - | - | - | 6N11A-3A |

Can't find your vehicle listed?
Visit www.yuasa.com for our latest application data

| CC | Model | Year | High Performance Maintenance Free | Maintenance Free VRLA | YuMicron | Conventional |
|----------------------------|--------------------|------|-----------------------------------|-----------------------|------------|--------------|
| INNOCENTI continued | | | | | | |
| 175 | Lambretta LI/DL | - | - | - | - | 6N11A-3A |
| 175 | Lambro FL1 | - | - | - | Y60-N24L-A | - |
| 200 | Lambro FL1 | - | - | - | Y60-N24L-A | - |
| 450 | Lambro | - | - | - | Y60-N24L-A | - |
| 550 | Lambro | - | - | - | Y60-N24L-A | - |
| 600 | Lambro | - | - | - | Y60-N24L-A | - |
| ITALJET | | | | | | |
| 50 | Adly | - | - | - | YB5L-B | - |
| 50 | Bazooka, 2 | - | - | - | YB4L-B | - |
| 50 | Cruise | - | - | - | YB4L-B | - |
| 50 | Dragster | 97 | - | - | YB4L-B | - |
| 50 | Formula | 95- | - | - | YB4L-B | - |
| 50 | Pista | - | - | - | YB4L-B | - |
| 50 | Reporter | - | - | - | YB4L-B | - |
| 50 | Scoop | - | - | - | YB4L-B | - |
| 50 | Torpedo | 97- | - | - | YB4L-B | - |
| 50 | Velocifero | 95- | - | - | YB4L-B | - |
| 125 | Dragster | 99 | - | - | YB10L-B | - |
| 125 | Formula | 97- | - | - | YB9-B | - |
| 125 | Millenium | - | - | YTX7A-BS | - | - |
| 125 | Torpedo | 99 | - | - | YB9-B | - |
| 150 | Millenium | - | - | YTX7A-BS | - | - |
| 150 | Torpedo | - | - | - | YB9-B | - |
| 180 | Dragster | 99 | - | YTX14-BS | - | - |
| JAWA | | | | | | |
| 180 | 360, 361 | - | - | - | - | B38-6A |
| 180 | 623, 633 | - | - | - | - | B38-6A |
| JIA LING HONDA | | | | | | |
| 125 | CB125T,X | - | - | - | - | 12N9-4B-1 |
| 125 | CG125 | - | - | - | - | 12N9-4B-1 |
| 125 | CH125 | - | - | - | - | 12N9-4B-1 |
| 125 | CM125 | - | - | - | - | 12N9-4B-1 |
| JIALING MOTOR | | | | | | |
| 90 | JH90 | - | - | - | YB5L-B | - |
| 125 | JH125 | - | - | - | - | 12N7-4B |
| 125 | JH125D | - | - | - | - | 12N7-3B |
| 150 | JH150T | - | - | YTX7A-BS | - | - |
| JIANGMEN DIHAO | | | | | | |
| 100 | HN100 | - | - | - | YB5L-B | - |
| 100 | 110-4, 6 | - | - | - | YB5L-B | - |
| 125 | HN125 | - | - | - | YB6L-B | - |
| 125 | HN125-3 | - | - | - | - | 12N9-4B-1 |
| 125 | HN125-4F | - | - | - | YB7-A | - |
| 125 | HN125T | - | - | YTX7A-BS | - | - |
| 125 | 125T-2C | - | - | YTX9-BS | - | - |
| 125 | 125T-A, B, C, D | - | - | YTX7A-BS | - | - |
| 125 | CG125-4, 4A, 9, 9A | - | - | - | YB9L-A2 | - |

| CC | Model | Year | High Performance Maintenance Free | Maintenance Free VRLA | YuMicron | Conventional |
|---------------------------------|-----------------------|------|-----------------------------------|-----------------------|----------|--------------|
| JIANGMEN DIHAO continued | | | | | | |
| 125 | CG125-7 | - | - | - | - | 12N9-4B-1 |
| 125 | HN125-3A | - | - | - | YB9L-A2 | - |
| 150 | 150-2 | - | - | - | - | 12N7A-3A |
| 150 | 150-6, 7, 8 | - | - | - | - | 12N9-4B-1 |
| 150 | 150J-5A, 8A | - | - | - | - | 12N9-4B-1 |
| 150 | CG150-3 | - | - | YTX7L-BS | - | - |
| JIANSHE YAMAHA | | | | | | |
| 90 | JYM90 | - | - | YT4L-BS | - | - |
| 100 | 5WY | - | - | YTX5L-BS | - | - |
| 100 | JOG | - | - | YTX5L-BS | - | - |
| 125 | 27S | - | - | YTX7L-BS | - | - |
| 125 | 4KL | - | - | YTX7A-BS | - | - |
| 125 | JYM125 | - | - | - | YB5L-B | - |
| 125 | 3D92 | - | - | YTX7L-BS | - | - |
| - | 5WG | - | - | YTX7A-BS | - | - |
| - | 4FP | - | - | YTX7A-BS | - | - |
| JINAN SUZUKI | | | | | | |
| 100 | QS100TB | - | - | YTX7A-BS | - | - |
| 110 | GM110 | - | - | - | YB5L-B | - |
| 110 | QS110L.QS110LS.QS110F | - | - | - | YB5L-B | - |
| 110 | FD110 | - | - | - | YB5L-B | - |
| 125 | QS125-3B.GS125GC | - | - | - | - | 12N7-4A |
| 125 | QS125-5.QS125-5C | - | - | - | - | 12N7A-3A |
| 125 | QS125T-2 | - | - | YTX7A-BS | - | - |
| 125 | GS125 | - | - | - | YB7-A | - |
| 125 | GS125-4K | - | - | YTX7A-BS | - | - |
| 125 | GSX125 | - | - | - | - | 12N7-4A |
| 125 | GT125 | - | - | - | - | 12N7A-3A |
| 125 | GZ125 | - | - | YTX7L-BS | - | - |
| 150 | QS150TFB | - | - | YTX7A-BS | - | - |
| JINCHERG GROUP | | | | | | |
| 110 | SJ110 | - | - | - | YB5L-B | - |
| 125 | SJ125 | - | - | YTX7L-BS | - | - |
| 125 | JC125T-17 | - | - | YTX12-BS | - | - |
| 250 | JC250 | - | - | YTX9-BS | - | - |
| KASEA | | | | | | |
| 50 | Sense, Prima | All | - | YTX5L-BS | - | - |
| 125 | RX125 | All | - | YTX7A-BS | - | - |
| KAWASAKI | | | | | | |
| 50 | AE50 A1, AR50 A1 | -92 | - | - | - | 6N6-1D-2 |
| 50 | AE50 | - | - | - | - | 6N6-1D-2 |
| 50 | AR50 C2-C4 | - | - | - | YB12A-A | - |
| 50 | AR50 C5 (EU) | - | - | - | YB12A-A | - |
| 50 | AR50 C5 (GR, UK) | - | - | - | - | 6N6-3B-1 |
| 50 | AR50 C6-C10 | - | - | - | - | 6N6-1D-2 |
| 50 | AV50 | -92 | - | - | - | 6N6-1D-2 |

World number one for motorcycle batteries

| CC | Model | Year | High Performance Maintenance Free | Maintenance Free VRLA | YuMicron | Conventional |
|---------------------------|------------------------|-------|-----------------------------------|-----------------------|------------|--------------|
| KAWASAKI continued | | | | | | |
| 50 | KMX50A | 88- | - | - | - | 6N6-1D-2 |
| 50 | MX50A | -95 | - | - | - | 6N6-1D-2 |
| 50 | MX50B, B2 | -98 | - | - | YB2.5L-C-4 | - |
| 80 | AE80, AR80A | -98 | - | - | - | 6N6-1D-2 |
| 80 | AR80 C2-C8 | - | - | - | - | 6N6-1D-2 |
| 80 | KMX80 | 88- | - | - | - | 6N6-1D-2 |
| 80 | MX80B | -98 | - | - | YB2.5L-C-4 | - |
| 90 | AN90B | -95 | - | - | - | 12N5.5A-3B |
| 90 | G3SS Series | 69-72 | - | - | - | 6N4-2A-3 |
| 90 | G3SS Series | 73-74 | - | - | - | 6N4-2A-5 |
| 90 | G3TR Series | 69-70 | - | - | - | 6N4-2A-3* |
| 90 | MC1 Series | 73-75 | - | - | - | 6N4-2A-5 |
| 100 | G3SS Series | 75 | - | - | - | 6N4-2A-5 |
| 100 | G3TR Series | 71 | - | - | - | 6N4-2A-3* |
| 100 | G4TR Series | 70-72 | - | - | - | 6N2-2A-3 |
| 100 | G4TR Series | 73-75 | - | - | - | 6N4-2A-5 |
| 100 | G5 Series | 72-73 | - | - | - | 6N4-2A-3 |
| 100 | G5 Series | 74-75 | - | - | - | 6N4-2A-5 |
| 100 | KE100 B16-B17 | 82- | - | - | - | 6N6-1D-2 |
| 100 | KE100, B1-B15 (EU) | - | - | - | - | 6N4-2A-5 |
| 100 | KE100A, KM100A | 76-78 | - | - | - | 6N4-2A-5 |
| 100 | KE100A, KM100A | 79-81 | - | - | - | 6N6-1D-2 |
| 100 | KE100-B | 82-01 | - | - | - | 6N6-1D-2 |
| 100 | KH100 G5-G8 | - | - | - | - | 6N6-3B-1 |
| 100 | KH100-B | 76-77 | - | - | - | 6N4-2A-5 |
| 100 | KH100H | -95 | - | - | - | 6N6-3B-1 |
| 100 | KM100 | -92 | - | - | - | 6N6-1D-2 |
| 100 | KM100-A | 76-78 | - | - | - | 6N4-2A-5 |
| 100 | KM100-A | 79-81 | - | - | - | 6N6-1D-2 |
| 100 | KV100-A | 76 | - | - | - | 6N4-2A-5 |
| 110 | KLX110L | 03-16 | - | YTX4L-BS | - | - |
| 110 | KLX110L | 17- | - | YTX7L-BS | - | - |
| 110 | KSR110 | 05- | YTX4L-BS | YT4L-BS | - | - |
| 120 | C2SS RoadRunner | 67-69 | - | - | - | 6N4-2A-3 |
| 120 | C2TR RoadRunner | 67-69 | - | - | - | 6N4-2A-3 |
| 125 | AR125 A1A-A8 | - | - | - | - | 12N5-3B |
| 125 | AR125 B1-B8 | - | - | - | - | 12N5-3B |
| 125 | AR125 S | - | - | - | - | 12N5-3B |
| 125 | ATHLETE 125 | 10 | YTZ4V, YTZ5S | - | - | - |
| 125 | BN125 | 01-07 | - | - | YB9-B | - |
| 125 | BN125 A1-A2 Eliminator | 01-04 | - | - | YB9-B | - |
| 125 | D-Tracker 125 | 09- | - | YTX7L-BS | - | - |
| 125 | F6 Series | 71-73 | - | - | - | 6N4-2A-5 |
| 125 | K125K | -94 | - | - | - | 6N6-3B-1 |
| 125 | K125-K7 | -94 | - | - | YB3L-B | - |
| 125 | KDX125 A1-A4, SR | 94-95 | - | - | YB3L-A | - |
| 125 | KDX125 B1-B4 | - | - | - | YB3L-A | - |
| 125 | KE125 A8-A12 | -95 | - | - | - | 6N6-1D-2 |
| 125 | KE125-A | 76-83 | - | - | - | 6N6-1D-2 |
| 125 | KH125 K1-K6 | - | - | - | - | 6N6-3B-1 |
| 125 | KH125 K7, K10 | - | - | - | YB3L-B | - |
| 125 | KH125 L1 | - | - | - | - | 6N6-3B-1 |
| 125 | KLX125 | 13- | - | YTX7L-BS | - | - |

*Use 6N4-2A-5 for engine production #235611 and above

| CC | Model | Year | High Performance Maintenance Free | Maintenance Free VRLA | YuMicron | Conventional |
|---------------------------|-------------------------------|-------|-----------------------------------|-----------------------|----------|--------------|
| KAWASAKI continued | | | | | | |
| 125 | KMX125 A1-A8, A11 | 86-02 | - | - | YB4L-B | - |
| 125 | KMX125 B1-B9 | 91- | - | - | YB4L-B | - |
| 125 | KS125 Series | 74-75 | - | - | - | 6N6-1D-2 |
| 125 | Z125 PRO | 16- | - | YTX4L-BS | - | - |
| 140 | KLX140, L | 08-16 | YTZ8V | YTX7L-BS | - | - |
| 150 | D-TRACKER 150 | 08 | - | YTX7L-BS | - | - |
| 150 | KLX 150 | 08 | - | YTX7L-BS | - | - |
| 175 | F7 Series | 71-75 | - | - | - | 6N4-2A-5 |
| 175 | KDX175 B | -92 | - | - | - | 6N4B-2A |
| 175 | KE175 B | 76-78 | - | - | - | 6N6-1D-2 |
| 175 | KE175 D, F | -92 | - | - | - | 6N6-1D-2 |
| 200 | KDX200 B1-B2 | -92 | - | - | YB3L-A | - |
| 200 | KMX200 A2-A5 | -97 | - | - | YB4L-B | - |
| 200 | KZ200 A, C | -95 | - | - | YB10L-B | - |
| 250 | 250TR (BJ250F) | 02- | - | YTX7L-BS | - | - |
| 250 | A1 Series | 66-71 | - | - | YB9-B | 12N9-4B-1 |
| 250 | D-Tracker (LX250E) | 02- | - | YTX7L-BS | - | - |
| 250 | EL250 A, B, C Eliminator | 91-96 | - | YTX7L-BS | - | - |
| 250 | EL250 D, E, F | - | - | - | YB9L-A2 | - |
| 250 | EL250, HS | 88-93 | - | - | YB9L-A2 | - |
| 250 | EL252 | 96-02 | - | - | YB9L-A2 | - |
| 250 | ER250 A | -95 | - | - | YB9L-B | - |
| 250 | ER250 B2-B3 | 83-84 | - | - | YB9L-B | - |
| 250 | Estrella-BJ250 A2, A3, C2, C3 | 92- | - | YTX9-BS | - | - |
| 250 | EX250 Ninja | 86-94 | - | - | YB9L-A2 | - |
| 250 | EX250 Ninja | 95-07 | - | YTX7L-BS | - | - |
| 250 | EX250 Ninja 250R | 08- | - | YTX7A-BS | - | - |
| 250 | EX250 Ninja 250R | 09-13 | - | YTX9-BS | - | - |
| 250 | F4 Series | 69-70 | - | - | - | 12N5.5-4A |
| 250 | F8 Series | 71-72 | - | - | - | 6N2-2A-3 |
| 250 | F11 Series | 73-75 | - | - | - | 6N4B-2A-3 |
| 250 | GPX250R EX250 F2-F8 | 87- | - | - | YB9L-A2 | - |
| 250 | GPX250R-II (EX250G1) | 88- | - | - | YB9L-A2 | - |
| 250 | GPZ250 EX250H1-H4 | 83- | - | - | YB9L-A2 | - |
| 250 | GPZ250R EX250 F9-F13 | 95- | - | YTX7L-BS | - | - |
| 250 | GPZ250R EX250 H5-H9 | 95- | - | YTX7L-BS | - | - |
| 250 | KE250 B | 77-79 | - | - | - | 6N6-1D-2 |
| 250 | KH250 A | 77 | - | - | - | 12N5.5-4A |
| 250 | KH250 B | 76-77 | - | - | - | 12N5.5-3B |
| 250 | KH250-A | 76 | - | - | - | 12N5.5-4A |
| 250 | KL250 | 78-84 | - | - | - | 6N6-1D-2 |
| 250 | KL250 A | 78-82 | - | - | - | 6N6-1D-2 |
| 250 | KL250 D2-D16 | - | - | - | YB4L-B | - |
| 250 | KL250 Super Sherpa | 00-04 | - | YTX7L-BS | - | - |
| 250 | KL250C | 83-84 | - | - | - | 6N6-1D-2 |
| 250 | KL250-D KLR | 85-05 | - | - | YB4L-A | - |
| 250 | KL250G, H Super Sherpa | 00-04 | - | YTX7L-BS | - | - |
| 250 | KLE250 Anheló (LE250A) | -97 | - | YTX7L-BS | - | - |
| 250 | KLR250 D-KL250D | 85-04 | - | - | YB4L-A | - |
| 250 | KLX250 | - | - | YTX7L-BS | - | - |
| 250 | KLX250 B | 82-83 | - | - | - | 6N4B-2A |
| 250 | KLX250ES G1/G2 | 94-95 | - | YTX7L-BS | - | - |
| 250 | KLX250S, SF | 06-13 | - | YTX7L-BS | - | - |

Can't find your vehicle listed?
 Visit www.yuasa.com for our latest application data

| CC | Model | Year | High Performance Maintenance Free | Maintenance Free VRLA | YuMicron | Conventional |
|---------------------------|------------------------|-------|-----------------------------------|-----------------------|----------|--------------|
| KAWASAKI continued | | | | | | |
| 250 | KR250 B, C, KR, 1S | -92 | - | - | YB4L-B | - |
| 250 | KZ250 A | 79-82 | - | - | YB10L-A2 | - |
| 250 | KZ250 CSR, LTD | 80-83 | - | - | YB10L-A2 | 12N10-3A-2 |
| 250 | KZ250 W LTD | 83-95 | - | - | YB10L-A2 | - |
| 250 | KZ250C | 80-82 | - | - | YB10L-A2 | - |
| 250 | KZ250D LTD | 80 | - | - | YB10L-A2 | - |
| 250 | KZ250G LTD | 81-82 | - | - | YB10L-A2 | - |
| 250 | KZ250L CSR | 82 | - | - | YB10L-A2 | - |
| 250 | LTD250 | 80-81 | - | - | YB10L-A2 | - |
| 250 | LX250 G, F | 95 | - | - | YB10L-A2 | - |
| 250 | Ninja 250, SL | 13- | - | YTX9-BS | - | - |
| 250 | S1 Series | 73-75 | - | - | - | 12N5.5-4A |
| 250 | Z250 A, C, J, LTD | -92 | - | - | YB10L-A2 | - |
| 250 | Z250 GP C1 | 81 | - | - | YB9L-A2 | - |
| 250 | Z250 | 13- | - | YTX9-BS | - | - |
| 250 | ZR250A, B Balius | 91- | - | YTX7L-BS | - | - |
| 250 | ZXR250, R (ZX250A, C) | 90- | - | - | YB9L-A2 | - |
| 250 | ZZ-R (EX250H) | 90-93 | - | - | YB9L-A2 | - |
| 250 | ZZ-R (EX250H) | 99-02 | - | YTX7L-BS | - | - |
| 300 | EX300 Ninja, ABS | 13-16 | - | YTX9-BS | - | - |
| 300 | J300 | 16 | - | YT12A-BS | - | - |
| 300 | J300 ABS | 14-16 | - | YT12A-BS | - | - |
| 305 | EX305 A1, B GP | 83 | - | - | YB9L-A2 | - |
| 305 | GPZ305 | 83 | - | - | YB9L-A2 | - |
| 305 | KZ305 A CSR, LTD | 81-88 | - | - | YB10L-A2 | - |
| 305 | KZ305B CSR | 82 | - | - | YB10L-A2 | - |
| 305 | KZ305B LTD | 87-88 | - | - | YB10L-A2 | - |
| 305 | LTD305 | 87 | - | - | YB10L-A2 | - |
| 305 | Z305 (CSR305) | 88 | - | - | YB10L-A2 | - |
| 350 | A7 Series | 66-71 | - | - | YB9-B | 12N9-4B-1 |
| 350 | F5 Series | 70-71 | - | - | - | 6N2-2A-3 |
| 350 | F9 Series | 72 | - | - | - | 6N2-2A-3 |
| 350 | F9 Series | 73-75 | - | - | - | 6N4B-2A-3 |
| 350 | S2 Series | 72-73 | - | - | - | 12N5.5-4A |
| 400 | 400 KH400-A | 76-78 | - | - | - | 12N5.5-4A |
| 400 | EN400, -Twin | 94 | - | - | YB12A-A | - |
| 400 | EN400B Vulcan | 95 | - | - | YB12A-A | - |
| 400 | ER-4n, ABS | 10- | - | YTX7L-BS | - | - |
| 400 | EX4 (EX400 A2/A3, B) | 94 | - | - | YB14L-A2 | - |
| 400 | FX400R (ZX400A) | - | - | - | YB12A-A | - |
| 400 | FX400R (ZX400C2-C4, D) | - | - | - | YB12A-AK | - |
| 400 | GPX400R (ZX400F) | - | - | - | YB12A-AK | - |
| 400 | GPZ400F-II (KZ400M) | 83- | - | - | YB12A-AK | - |
| 400 | GPZ400R (ZX400D) | 85-87 | - | - | YB12A-AK | - |
| 400 | GPZ400S (EX400A) | - | - | - | YB14L-A2 | YB12A-AK |
| 400 | KH400 | 92 | - | - | - | 12N5.5-3B |
| 400 | KH400A | 76-78 | - | - | - | 12N5.5-4A |
| 400 | KLE400 (LE400A) | 91- | - | YTX12-BS | - | - |
| 400 | KLX400R, KLX400SR | 03-04 | - | YT7B-BS | - | - |
| 400 | KX400H | 79 | - | - | YB12A-A | - |
| 400 | KZ400 Deluxe | 77-79 | - | - | YB12A-A | 12N12A-4A-1 |
| 400 | KZ400A Deluxe | 77-78 | - | - | - | 12N12A-4A-1 |
| 400 | KZ400-aS | 75-77 | - | - | - | 12N5.5-4A |

| CC | Model | Year | High Performance Maintenance Free | Maintenance Free VRLA | YuMicron | Conventional |
|---------------------------|---------------------------|-------|-----------------------------------|-----------------------|-----------|--------------|
| KAWASAKI continued | | | | | | |
| 400 | KZ400C, S | 75- | - | - | - | 12N5.5-4A |
| 400 | KZ400-D, H | 74-79 | - | - | YB12A-A | 12N12A-4A-1 |
| 400 | KZ400J | 80-82 | - | - | YB12A-A | - |
| 400 | Mach II | - | - | - | - | 12N5.5-4B |
| 400 | March | - | - | - | - | 12N5.5-4A |
| 400 | Ninja 400, ABS | - | - | YT12A-BS | - | - |
| 400 | Ninja 400R, ABS | 10- | - | YTX12-BS | - | - |
| 400 | S3 Series | 74-75 | - | - | - | 12N5.5-4A |
| 400 | VN400A, C Vulcan | 95- | - | YTX12-BS | - | - |
| 400 | Z400 Custom (KZ400B) | 78- | - | - | YB12A-A | - |
| 400 | Z400 F ZR400B | 84 | - | - | YB12A-AK | - |
| 400 | Z400F-II (ZX400C) | 91- | - | - | YB12A-AK | - |
| 400 | Z400FX (KZ400E) | 77-79 | - | - | YB12A-AK | - |
| 400 | Z400GP (ZX400A) | - | - | - | YB12A-AK | - |
| 400 | Z400LTD, -II, (KZ400H, K) | - | - | - | YB12A-A | 12N12A-4A-1 |
| 400 | ZL400, A1 Eliminator | 86- | - | - | YB12A-AK | - |
| 400 | ZR400 B1 | - | - | - | YB12A-AK | - |
| 400 | ZR400C, G Zephyr | -93 | - | - | YB12A-AK | - |
| 400 | ZR400C, G Zephyr | 93- | - | YTX12-BS | - | - |
| 400 | ZR400D Xanthus | 92- | - | YTX9-BS | - | - |
| 400 | ZRX, -II (ZR400E, F, D) | 95- | - | YTX9-BS | - | - |
| 400 | ZX-4 (ZX400G) | - | - | - | YB12A-AK | - |
| 400 | ZX400H | 92 | - | - | YB12A-A | - |
| 400 | ZXR400, R (ZX400L, H) | 91 | - | - | YB12A-AK | - |
| 400 | ZXR400, R (ZX400M, L) | 92-02 | - | YTX9-BS | - | - |
| 400 | ZZ-R400 (ZX400K) | -92 | - | - | YB12A-AK | - |
| 400 | ZZ-R400 (ZX400N) | 93- | - | YTX12-BS | - | - |
| 440 | KZ440 (All) | 80-84 | - | - | YB12A-A | - |
| 440 | LTD440 | 80- | - | - | YB12A-A | - |
| 450 | EN450-A 454 LTD | 85-90 | - | - | YB12A-A | - |
| 450 | KLX450R | 08-10 | YTZ7S | - | - | - |
| 450 | Z450 LTD | 87-89 | - | - | YB12A-A | - |
| 500 | EN500 LTD | 90-95 | - | - | YB12A-A | - |
| 500 | EN500-A Vulcan | 90-96 | - | - | YB12A-A | - |
| 500 | EN500-C Vulcan LTD | 96-08 | - | - | YB12AL-A2 | - |
| 500 | EN500D Ninja 500R | 94-04 | - | - | YB14L-A2 | - |
| 500 | ER5 (ER500A, B) | 97- | - | YTX12-BS | - | - |
| 500 | ER525KW | 97-01 | - | YTX12-BS | - | - |
| 500 | ER537KW | 97-01 | - | YTX12-BS | - | - |
| 500 | EX500 | 87-98 | - | - | YB14L-A2 | - |
| 500 | EX500-A | 87-93 | YTX14AHL-BS | - | YB14L-A2 | - |
| 500 | EX500-D Ninja 500R | 94-08 | YTX14AHL-BS | - | YB14L-A2 | - |
| 500 | GPZ500S (EN500D, E, F) | 87-02 | - | - | YB14L-A2 | - |
| 500 | H1 Series | 69-72 | - | - | YB9-B | 12N9-4B-1 |
| 500 | H1 Series | 73-75 | - | - | YB9L-B | 12N9-3B |
| 500 | KH500-A | 76 | - | - | YB9L-B | 12N9-3B |
| 500 | KLE500 (LE500) | 91-02 | - | YTX12-BS | - | - |
| 500 | KZ500B | 79-80 | - | - | YB12A-A | - |
| 550 | GPZ550 | 82-87 | - | - | YB12A-A | - |
| 550 | GPZ550E/L | - | - | - | YB12A-AK | - |
| 550 | GT550 | 89-93 | - | - | YB12A-A | - |
| 550 | KZ550, LTD, GP | 80-83 | - | - | YB12A-A | - |
| 550 | KZ550B, G, LTD, GP | 79-89 | - | - | YB12A-A | - |

World number one for motorcycle batteries

| CC | Model | Year | High Performance Maintenance Free | Maintenance Free VRLA | YuMicron | Conventional |
|---------------------------|-----------------------------|-------|-----------------------------------|-----------------------|--------------|--------------|
| KAWASAKI continued | | | | | | |
| 550 | KZ550-F LTD | 84 | - | - | YB12A-A (ta) | - |
| 550 | KZ550-F Spectre | 83 | - | - | YB12A-A (ta) | - |
| 550 | KZ550-H GP | 82-83 | - | - | YB12A-A (s) | - |
| 550 | LTD550 C1 | 80 | - | - | YB12A-A | - |
| 550 | LTD550 C2 | 81 | - | - | YB12A-A | - |
| 550 | LTD550 C3 | 82 | - | - | YB12A-A | - |
| 550 | LTD550 C4 | 83 | - | - | YB12A-A | - |
| 550 | VLE500A | 91 | - | YTX12-BS | - | - |
| 550 | ZF550 | - | - | - | YB12A-AK | - |
| 550 | ZR550A | 83 | - | - | YB12A-A | - |
| 550 | ZR550B Zephyr | 94-97 | - | YTX12-BS | - | - |
| 550 | ZR550B Zephyr | 90-93 | - | - | YB12A-A | - |
| 550 | ZX550A GPZ | 84-89 | - | - | YB12A-AK | - |
| 550 | ZZ-R500 Ninja (ZX500D) | -98 | - | YTX12-BS | - | - |
| 600 | GPX600C Warbird | 88-94 | - | - | YB12A-A | - |
| 600 | GPZ600E/L | - | - | - | YB12A-AK | - |
| 600 | GPZ600R (ZX600A) | 87-88 | - | - | YB12A-A | - |
| 600 | KL600A KLR (Kick-Starter) | 89-90 | - | - | YB4L-B | - |
| 600 | KL600A KLR (Kick-Starter) | 90-91 | - | - | YB4L-A | - |
| 600 | KL600-B KLR | 85-86 | YTX14AHL-BS | - | YB14L-A2 | - |
| 600 | KL600R, KLR600 (KL600B) | 85-88 | - | - | YB14L-A2 | - |
| 600 | ZL600A Eliminator | 86-87 | - | - | YB12A-A | - |
| 600 | ZL600B Eliminator | 95-96 | - | - | YB12A-AK | - |
| 600 | ZX600 G/H/R | 95-97 | - | YTX12-BS | - | - |
| 600 | ZX600-A, B, C, D Ninja | 85-96 | - | - | YB12A-A | - |
| 600 | ZX600D ZZR | 90-92 | - | - | YB12A-A | - |
| 600 | ZX600E ZZR Ninja | 93-02 | - | YTX12-BS | - | - |
| 600 | ZX600-E, F Ninja ZX-6, 6R | 93-02 | - | YTX12-BS | - | - |
| 600 | ZX600F ZX-6R Ninja | 95-98 | - | YTX12-BS | - | - |
| 600 | ZX600-FA Ninja ZX-6R | 08-16 | - | YTX9-BS | - | - |
| 600 | ZX600-G, J Ninja ZX-6R | 98-08 | - | YTX9-BS | - | - |
| 600 | ZX600-K, M, N Ninja ZX-6RR | 03-06 | - | YTX9-BS | - | - |
| 600 | ZX-6R Ninja (ZX636A) | 03- | - | YTX9-BS | - | - |
| 600 | ZZR600 | 05-08 | - | YTX9-BS | - | - |
| 600 | ZZR600 | 02-04 | - | YTX12-BS | - | - |
| 600 | ZZR600 | 98-02 | - | YTX9-BS | - | - |
| 636 | ZX636-B, C Ninja ZX-6R, ABS | 03-16 | - | YTX9-BS | - | - |
| 650 | EJ650 | 99-00 | - | YTX14-BS | - | - |
| 650 | ER6, F, N | 06- | - | YT12A-BS | - | - |
| 650 | ER650-A, B | 06 | - | YTX12-BS | - | - |
| 650 | EX650-A, B | 06 | - | YTX12-BS | - | - |
| 650 | GPZ650R | 92 | - | - | YB12A-A | - |
| 650 | KL650-A, E, KLR | 87-16 | YTX14AHL-BS | - | YB14L-A2 | - |
| 650 | KL650-B Tengai | 90-91 | YTX14AHL-BS | - | YB14L-A2 | - |
| 650 | KLE650, A, B (Versys) | 08-16 | - | YTX12-BS | - | - |
| 650 | KLR650 (KL650A) | 87-91 | - | - | YB14L-A2 | - |
| 650 | KLR650C | 95-02 | - | - | YB14L-A2 | - |
| 650 | KLX650C, R | 93-96 | - | YTX9-BS | - | - |
| 650 | KLX650 (LX650C) | 93-95 | - | YTX9-BS | - | - |
| 650 | KZ650 SR, LTD, Custom | 77-80 | - | - | YB10L-A2 | 12N10-3A-2 |
| 650 | KZ650B | 77-78 | - | - | YB10L-A2 | - |
| 650 | KZ650C, D SR, E LTD, F | 78-83 | - | - | YB10L-A2 | - |
| 650 | KZ650-H CSR | 81-83 | - | - | YB12A-A | - |

(ta) YB12A-A - When ordering this battery specify terminal adapter (s) YB12A-A - When ordering this battery specify sensor



| CC | Model | Year | High Performance Maintenance Free | Maintenance Free VRLA | YuMicron | Conventional |
|---------------------------|----------------------------|-------|-----------------------------------|-----------------------|-------------|--------------|
| KAWASAKI continued | | | | | | |
| 650 | Ninja 650R | 06-11 | - | YTX12-BS | - | - |
| 650 | Ninja 650R, Ninja 650R ABS | 12-16 | - | YT12A-BS | - | - |
| 650 | Tengai | - | - | - | YB14L-A2 | - |
| 650 | Versys 650 / ABS | 11-16 | - | YTX12-BS | - | - |
| 650 | Vulcan, S | - | YTZ10S | - | - | - |
| 650 | W Series | 66-70 | - | - | YB7L-B | 12N7-3B |
| 650 | W650 | 00-02 | GYZ16H | YTX14-BS | - | - |
| 650 | Z650 SR | 77-79 | - | - | YB10L-A2 | - |
| 650 | Z650B1/B2/ZBSR | - | - | - | YB10L-A2 | - |
| 700 | KZ700-A | 84 | - | - | YB12A-A | - |
| 700 | VN700-A Vulcan | 85 | YTX14AHL-BS | - | YB14L-A2 | - |
| 700 | ZN700 LTD (ZN700A) | 95 | - | - | YB14L-A2 | - |
| 700 | ZN700-A LTD | 84-85 | YTX14AHL-BS | - | YB14L-A2 | - |
| 750 | GPX750R (ZX750F) | 87 | - | - | YB14L-A2 | - |
| 750 | GPZ750, F (ZX750A, E) | 83-85 | - | - | SYB14L-A2 | - |
| 750 | GPZ750A, E, G | 92 | - | - | YB14L-A2 | - |
| 750 | GPZ750R | 92 | - | - | YB12A-A | - |
| 750 | GPZ750R Ninja (ZX750G) | 85 | - | - | YB14L-A2 | - |
| 750 | GT750 | 92 | - | - | SYB14L-A2 | - |
| 750 | H2 Series | 72-75 | - | - | - | 12N5.5-4A |
| 750 | KZ750, LTD, CSR | 76-79 | - | - | SYB14L-A2 | - |
| 750 | KZ750A | 95 | - | - | SYB14L-A2 | - |
| 750 | KZ750B, G LTD | 76-80 | - | - | YB14L-A2 | - |
| 750 | KZ750D | 95 | - | - | YB14L-A2 | - |
| 750 | KZ750-E, H, L LTD | 80-83 | - | - | YB12A-A | - |
| 750 | KZ750-F LTD, Spectre | 83 | YTX14AHL-BS | - | YB14L-A2 | - |
| 750 | KZ750H LTD, L LTD, GP | 80-83 | - | - | YB12A-A | - |
| 750 | KZ750K LTD KI | 83 | - | - | YB14L-A2 | - |
| 750 | KZ750K LTD, M CSR | 82-84 | - | - | SYB14L-A2 | - |
| 750 | KZ750-L Ninja K | 93 | - | YTX9-BS | - | - |
| 750 | KZ750P GT | 82-85 | - | - | SYB14L-A2 | - |
| 750 | KZ750-R GP | 82 | - | - | YB12A-A (s) | - |
| 750 | KZ750R L III-L IV | 83-84 | - | - | YB12A-A | - |
| 750 | KZ750Y LTD Y I-Y II | 82-83 | - | - | YB14L-A2 | - |
| 750 | VN750-A Vulcan | 86-06 | YTX14AHL-BS | - | YB14L-A2 | - |
| 750 | Z750 (EU) | 09-12 | - | YTX9-BS | - | - |
| 750 | ZN750-A LTD | 84-85 | YTX14AHL-BS | - | YB14L-A2 | - |
| 750 | ZR-7, S (ZR750) | 00- | - | YTX12-BS | - | - |
| 750 | ZR750 (Z750S) | 05-06 | - | YTX9-BS | - | - |
| 750 | ZR750-C Zephyr | 91-94 | - | YTX12-BS | - | - |
| 750 | ZR750C, D Zephyr F | 99-02 | - | YTX12-BS | - | - |
| 750 | ZX750 Ninja ZX, 7RR | 91-97 | - | YTX9-BS | - | - |
| 750 | ZX750-E Turbo, GPz | 83-85 | - | - | SYB14L-A2 | - |
| 750 | ZX750-F Ninja | 87-90 | YTX14AHL-BS | - | YB14L-A2 | - |
| 750 | ZX750-H Ninja ZX-7 | 89 | YTX14AHL-BS | - | YB14L-A2 | - |
| 750 | ZX750-H Ninja ZX-7 | 90 | - | - | YB12AL-A2 | - |
| 750 | ZX750H ZXR HI Stinger | 89-92 | - | - | YB14L-A2 | - |
| 750 | ZX750-J Ninja ZX-7 | 91-95 | - | YTX12-BS | - | - |
| 750 | ZX750-JI | 91 | - | - | YB12AL-A2 | - |
| 750 | ZX750-P Ninja ZX-7R | 96-03 | - | YTX12-BS | - | - |
| 750 | ZX-7R, P Ninja | 96-03 | - | YTX12-BS | - | - |
| 750 | ZX-7RR Ninja | 96-97 | - | YTX9-BS | - | - |
| 750 | ZXR750 (ZX750H) | 90 | - | - | YB12AL-A2 | - |

(s) YB12A-A - When ordering this battery specify sensor

Can't find your vehicle listed?
Visit www.yuasa.com for our latest application data

| CC | Model | Year | High Performance Maintenance Free | Maintenance Free VRLA | YuMicron | Conventional |
|---------------------------|---|-------|-----------------------------------|-----------------------|----------|--------------|
| KAWASAKI continued | | | | | | |
| 750 | ZXR750 (ZX750L) | 91-93 | - | YTX12-BS | - | - |
| 750 | ZXR750, R (ZX750J) | 91- | - | YTX9-BS | - | - |
| 750 | ZXR750R (ZX750K, M) | 91- | - | YTX12-BS | - | - |
| 800 | VN800 A | 95-99 | - | YTX14-BS | - | - |
| 800 | VN800 Classic B | 96-02 | - | YTX14-BS | - | - |
| 800 | VN800 D | 99-02 | - | YTX14-BS | - | - |
| 800 | VN800-A, B, C, E Vulcan, Classic, Drifter | 95-03 | - | YTX14-BS | - | - |
| 800 | VN800-A, B, E Vulcan, Classic, Drifter | 04-06 | - | YTX12-BS | - | - |
| 800 | W800, Special Edition | 11- | - | YTX12-BS | - | - |
| 800 | Z800 | 13-16 | - | YTX9-BS | - | - |
| 900 | A4 900 | - | - | - | YB10L-A2 | - |
| 900 | GPZ900R (ZX900A) | 84-93 | - | - | YB14L-A2 | - |
| 900 | KZ900, A, B, LTD | 76-77 | - | - | YB10L-A2 | - |
| 900 | VN900, B, C, D | 06 | - | YTX12-BS | - | - |
| 900 | Vulcan 900 Classic | 06- | - | YTX12-BS | - | - |
| 900 | Z1 Series | 73-75 | YTX14AHL-BS | - | YB14L-A2 | 12N14-3A |
| 900 | ZL900-A Eliminator | 85-86 | YTX14AHL-BS | - | YB14L-A2 | - |
| 900 | ZX900- E, F Ninja (ZX-9R) | 00-03 | - | YTX9-BS | - | - |
| 900 | ZX900-B Ninja (ZX-9R) | 94-97 | - | YTX12-BS | - | - |
| 900 | ZX900-C Ninja (ZX-9R) | 98-99 | - | YTX9-BS | - | - |
| 900 | ZX-9R (ZX900B) Ninja | 94-97 | - | YTX12-BS | - | - |
| 900 | ZX-9R (ZX900C, D) Ninja | 98-02 | - | YTX9-BS | - | - |
| 900 | ZX-9R (ZX900E, F) Ninja | 00-03 | - | YTX9-BS | - | - |
| 1000 | H2R | 14- | YTX10S | - | - | - |
| 1000 | GPZ1000RX A | 86-87 | - | - | YB14L-A2 | - |
| 1000 | GTR1000 (ZGT00A) | 86-02 | - | - | YB18L-A | - |
| 1000 | KZ1000 LTD K | 81 | - | - | YB18L-A | - |
| 1000 | KZ1000 R SS | 81-83 | - | - | YB18L-A | - |
| 1000 | KZ1000, LTD | 77-80 | YTX14AHL-BS | - | YB14L-A2 | - |
| 1000 | KZ1000, LTD, CSR | 81-83 | YTX20HL-BS | YTX20L-BS | YB18L-A | - |
| 1000 | KZ1000A | 77-78 | - | - | YB14L-A2 | - |
| 1000 | KZ1000B LTD | 77-78 | - | - | YB14L-A2 | - |
| 1000 | KZ1000-C Police | 80-81 | YTX20HL-BS | YTX20L-BS | YB16L-B | - |
| 1000 | KZ1000-C Police, Z1-R | 78-79 | YTX14AHL-BS | - | YB14L-A2 | - |
| 1000 | KZ1000-E ST, Shaft | 79-80 | YTX20HL-BS | YTX20L-BS | YB16L-B | - |
| 1000 | KZ1000-G Classic | 80 | YTX14AHL-BS | - | YB14L-A2 | - |
| 1000 | KZ1000J, M CSR | 81-83 | - | - | YB18L-A | - |
| 1000 | KZ1000P Police | 02-05 | - | YTX20L-BS | - | - |
| 1000 | KZ1000-P Police | 82-01 | YTX20HL-BS | YTX20L-BS | YB18L-A | - |
| 1000 | Ninja H2, H2R | 15- | YTX10S | - | - | - |
| 1000 | VERSYS 1000 | 12-16 | - | YTX9-BS | - | - |
| 1000 | KZ1000-R Replica | 82-83 | YTX20HL-BS | YTX20L-BS | YB18L-A | - |
| 1000 | Z1000 | 03-13 | - | YTX9-BS | - | - |
| 1000 | Z1000 | 14- | - | YT12A-BS | - | - |
| 1000 | Z1000 ABS | -13 | - | YTX9-BS | - | - |
| 1000 | Z1000 ABS | 14- | - | YT12A-BS | - | - |
| 1000 | Z1000 MK2 | 79-80 | - | - | YB14L-A2 | - |
| 1000 | Z1000A, B, C, D, G | 92 | - | - | YB14L-A2 | - |
| 1000 | Z1000GTR | 92 | - | - | YB18L-A | - |
| 1000 | Z1000J, K, LTD, R | 92 | - | - | YB18L-A | - |
| 1000 | Z1000ST | 92 | - | - | YB16L-B | - |
| 1000 | Z1-R (KZ1000D) | 78-80 | - | - | YB14L-A2 | - |
| 1000 | ZG1000-A Concours | 86-06 | YTX20HL-BS | YTX20L-BS | YB18L-A | - |

| CC | Model | Year | High Performance Maintenance Free | Maintenance Free VRLA | YuMicron | Conventional |
|---------------------------|---------------------------------|-------|-----------------------------------|-----------------------|---------------|--------------|
| KAWASAKI continued | | | | | | |
| 1000 | ZGT1000A | 95 | - | - | YB18L-A | - |
| 1000 | ZL1000A Eliminator | 87-92 | YTX14AHL-BS | - | YB14L-A2 | - |
| 1000 | ZX10 B Tomcat | 88-90 | - | - | YB14L-A2 | - |
| 1000 | ZX10 R | 04 | - | YT12B-BS | - | - |
| 1000 | ZX10R | 11-15 | YTZ7S | - | - | - |
| 1000 | ZX10R ABS | 11-16 | YTZ10S | - | - | - |
| 1000 | ZX1000A Concours | 96-97 | - | - | YB18L-A | - |
| 1000 | ZX1000-A Ninja 1000R, GPZ1000RX | 86-87 | YTX14AHL-BS | - | YB14L-A2 | - |
| 1000 | ZX1000-B Ninja ZX10 | 88-89 | YTX14AHL-BS | - | YB14L-A2 | - |
| 1000 | ZX1000-C Ninja ZX-10R | 04-09 | - | YT12B-BS | - | - |
| 1000 | ZX1000-B Ninja (ZX-10) | 88-89 | YTX14AHL-BS | - | YB14L-A2 | - |
| 1000 | ZX1000-C Ninja (ZX-10R) | 04-09 | - | YT12B-BS | - | - |
| 1000 | ZX10R | 86-90 | YTX14AHL-BS | - | YB14L-A2 | - |
| 1100 | GPZ1100 (ZXT10 E, F) | 95-97 | - | YTX14-BS | - | - |
| 1100 | GPZ1100A Unitrak | 83-85 | - | - | YB16L-B | - |
| 1100 | KZ1100-A, LTD | 81-83 | YTX20HL-BS | YTX20L-BS | YB18L-A | - |
| 1100 | KZ1100-B GP | 82 | - | - | YB16L-B | - |
| 1100 | KZ1100D Spectre | 82-83 | - | - | YB18L-A | - |
| 1100 | KZ1100L LTD | 83 | - | - | YB18L-A | - |
| 1100 | Z1100B | -92 | - | - | YB16L-B | - |
| 1100 | Z1100ST | 81-83 | - | - | YB18L-A | - |
| 1100 | Zephyr1100 (ZRT10A) | 97-98 | - | YTX16-BS | - | - |
| 1100 | ZG1100-A7, 8 | 94 | - | - | YB18L-A | - |
| 1100 | ZN1100-B LTD | 84-85 | YTX14AHL-BS | - | YB14L-A2 | - |
| 1100 | ZR1100 | 92-95 | YTX20CH-BS | YTX16-BS | - | - |
| 1100 | ZR1100A, B | 92-97 | - | YTX16-BS | - | - |
| 1100 | ZRX1100 | 99-00 | YTX14H-BS | YTX14-BS | - | - |
| 1100 | ZRX1100/II (ZRT10C, D) | 97-00 | - | YTX14-BS | - | - |
| 1100 | ZX-11 (ZX1100C) Ninja | 90-93 | - | - | YB14L-A2 | - |
| 1100 | ZX-11 (ZX1100D1) Ninja | 94-98 | - | YTX14-BS | - | - |
| 1100 | ZX1100 C-G | 99 | - | YTX14-BS | - | - |
| 1100 | ZX1100 D1 | 97-00 | - | YTX14-BS | - | - |
| 1100 | ZX1100-A GPz | 83-84 | - | - | YB16L-B | - |
| 1100 | ZX1100-C Ninja ZX-11 | 90-93 | YTX14AHL-BS | - | YB14L-A2 | - |
| 1100 | ZX1100-D Ninja ZX-11 | 95-01 | GYZ16H | YTX14-BS | - | - |
| 1100 | ZX1100-D Ninja ZX-11 (CN) | 93-94 | GYZ16H | YTX14-BS | - | - |
| 1100 | ZX1100-E (GPz1100), ABS | 95-97 | GYZ16H | YTX14-BS | - | - |
| 1100 | ZXR1100 C | 97 | - | YTX14-BS | - | - |
| 1100 | ZZR1100EU (ZXT10C) | 90-92 | - | - | YB14L-A2 | - |
| 1100 | ZZR1100EU (ZXT10D) | 93-01 | - | YTX14-BS | - | - |
| 1200 | ZG1200 Voyager XII | 86-03 | - | - | SY50-N18L-AT | - |
| 1200 | ZG1200A, B Voyager | 86-98 | - | - | SY50-N18L-AT | - |
| 1200 | ZRX1200 DAEG | 09- | - | YTX12-BS | - | - |
| 1200 | ZRX1200R | 01-05 | YTX14H-BS | YTX14-BS | - | - |
| 1200 | ZRX1200R/S (ZRT20A/B) | 01- | - | YTX14-BS | - | - |
| 1200 | ZX-1200A1 | 00- | - | YTX14-BS | - | - |
| 1200 | ZX-12R | 00-05 | YTX14H-BS | YTX14-BS | - | - |
| 1200 | ZZR1200 (ZXT20C) | 02-05 | YTX14H-BS | YTX14-BS | - | - |
| 1300 | KZ1300 Touring | 79-82 | - | - | Y50-N18L-A-CX | Y50-N18L-A |
| 1300 | KZ1300A | 79-83 | - | - | Y50-N18L-A | - |
| 1300 | KZ1300B Touring | 80 | - | - | Y50-N18L-A | - |
| 1300 | Z/ZG1300A | 84-89 | - | - | Y50-N18L-A | - |
| 1300 | ZGT1300A | 95- | - | - | Y50-N18L-A | - |

World number one for motorcycle batteries

| CC | Model | Year | High Performance Maintenance Free | Maintenance Free VRLA | YuMicron | Conventional |
|---------------------------|--|-------|-----------------------------------|-----------------------|---------------|--------------|
| KAWASAKI continued | | | | | | |
| 1300 | ZN1300A Europe | 83-92 | - | - | Y60-N24L-A | - |
| 1300 | ZN1300A Voyager | 83-88 | - | - | - | 12N24-3 |
| 1400 | 1400GTR | 07-14 | YTX14H-BS | - | - | - |
| 1400 | ZG1400 Concours, ABS | 08-16 | YTX14H-BS | YTX14-BS | - | - |
| 1400 | Ninja ZX-14R, ABS | 06-16 | YTX14H-BS | YTX14-BS | - | - |
| 1400 | ZZR1400 | 06- | YTX14H-BS | - | - | - |
| 1500 | VN1500 F, H | 00-02 | - | YTX16-BS | - | - |
| 1500 | VN1500 G1 Vulcan Nomad, Drifter | 99-04 | - | YTX16-BS | - | - |
| 1500 | VN1500 J1, 2 | 99-02 | - | YTX16-BS | - | - |
| 1500 | VN1500 L, H, N | 00 | - | YTX16-BS | - | - |
| 1500 | VN1500 Vulcan 88, SE | 87-98 | - | - | Y50-N18L-A-CX | Y50-N18L-A |
| 1500 | VN1500A, C Vulcan | 87-98 | - | - | Y50-N18L-A | - |
| 1500 | VN1500-C Vulcan L | 96-97 | - | - | Y50-N18L-A-CX | Y50-N18L-A |
| 1500 | VN1500-D, E, N Vulcan Classic | 96-08 | YTX20CH-BS | YTX16-BS | - | - |
| 1500 | VN1500-G, J, L, R, Vulcan Nomad, Drifter | 99-05 | YTX20CH-BS | YTX16-BS | - | - |
| 1500 | VN1500-P Vulcan Mean Streak | 02-03 | YTX20CH-BS | YTX16-BS | - | - |
| 1500 | VN1500SE B Vulcan | 88-94 | - | - | Y50-N18L-A | - |
| 1600 | VN1600-A Vulcan Classic, D, Nomad | 03-08 | YTX20CH-BS | YTX16-BS | - | - |
| 1600 | VN1600-B Vulcan Mean Streak | 04-08 | YTX20CH-BS | YTX16-BS | - | - |
| 1700 | VN1700 Voyager, Nomad, Vaquero | 09-16 | YTX20CH-BS | YTX16-BS | - | - |
| 2000 | VN2000-A Vulcan | 04-12 | YTX20CH-BS | YTX16-BS | - | - |
| KL-SHELUNG | | | | | | |
| 50 | Club | - | - | YTX4L-BS | - | - |
| 50 | Racer | - | - | YTX4L-BS | - | - |
| KREIDLER | | | | | | |
| 80 | Florett | - | - | - | YB7L-B | - |
| 125 | Mustang | - | - | - | YB7L-B | - |
| KTM | | | | | | |
| 50 | GO, Go Chrono | 95- | YTX4L-BS | YT4L-BS | - | - |
| 50 | Kross | - | - | - | YB4L-B | - |
| 80 | Chopper, PL | - | - | - | - | 12N9-4B-1 |
| 80 | RLW, RSL | - | - | - | - | 12N9-4B-1 |
| 125 | 125LC2 | 96-97 | YTX4L-BS | YT4L-BS | - | - |
| 125 | Duke | - | - | YTX7L-BS | - | - |
| 125 | Sting | 97-98 | YTX4L-BS | YT4L-BS | - | - |
| 125 | RC | 14- | - | YTX9-BS | - | - |
| 200 | EXC | - | YTX4L-BS | - | - | - |
| 200 | Duke | - | - | YTX9-BS | - | - |
| 250 | CB250F | 14- | - | YTX7L-BS | - | - |
| 250 | EXC | 03-05 | YTZ5S | - | - | - |
| 250 | EXC | 05- | - | YTX4L-BS | - | - |
| 250 | EXC Six Days | - | - | YTX4L-BS | - | - |
| 250 | EXC-F | 05- | - | YTX5L-BS | - | - |
| 250 | Freeride | 14- | - | YTX4L-BS | - | - |
| 250 | XC | - | - | YTX4L-BS | - | - |
| 250 | SX-F | - | - | YTX4L-BS | - | - |
| 250 | EXC-F | 05- | - | YTX4L-BS | - | - |
| 250 | EXC-F Six Days | - | - | YTX4L-BS | - | - |
| 250 | XC-F | - | - | YTX4L-BS | - | - |

| CC | Model | Year | High Performance Maintenance Free | Maintenance Free VRLA | YuMicron | Conventional |
|----------------------|--------------------------------------|-------|-----------------------------------|-----------------------|----------|--------------|
| KTM continued | | | | | | |
| 300 | EXC | - | - | YTX4L-BS | - | - |
| 300 | EXC Six Days | - | - | YTX4L-BS | - | - |
| 300 | XC | - | - | YTX4L-BS | - | - |
| 350 | Freeride | - | - | YTX5L-BS | - | - |
| 350 | XC-F | - | - | YTX5L-BS | - | - |
| 350 | EXC-F | - | - | YTX4L-BS | - | - |
| 350 | EXC-F Six Days | - | - | YTX4L-BS | - | - |
| 350 | SX-F | 11-16 | - | YTX4L-BS | - | - |
| 390 | Duke | 13- | - | YTX9-BS | - | - |
| 390 | RC | 14- | - | YTX9-BS | - | - |
| 400 | E/XC Racing 4-Stroke | 00-02 | - | YTX4L-BS | - | - |
| 400 | E/XC Racing 4-Stroke (Opt) | 00-02 | - | YTX5L-BS | - | - |
| 400 | EXC | - | - | YTX5L-BS | - | - |
| 400 | EXC Racing | 03- | YTZ5S | - | - | - |
| 400 | LC4 | 98 | - | YTX9-BS | - | - |
| 400 | LC4 E/XC | 96-98 | - | YTX9-BS | - | - |
| 400 | LC4-E | 97 | - | YTX9-BS | - | - |
| 400 | LS-E | 97 | - | YTX9-BS | - | - |
| 400 | RXC LC4 | 96-01 | - | YTX9-BS | - | - |
| 400 | XC-W | - | - | YTX5L-BS | - | - |
| 450 | EXC | - | - | YTX5L-BS | - | - |
| 450 | EXC Six Days | - | - | YTX5L-BS | - | - |
| 450 | EXC Racing | 03- | YTZ5S | - | - | - |
| 450 | MXC Racing | 00-02 | - | YTX5L-BS | - | - |
| 450 | SMR | - | - | YTX4L-BS | - | - |
| 450 | SX-F | 11-16 | - | YTX4L-BS | - | - |
| 450 | XC-F | - | - | YTX5L-BS | - | - |
| 450 | XC-W | - | - | YTX5L-BS | - | - |
| 500 | EXC | - | - | YTX5L-BS | - | - |
| 500 | EXC Six Days | - | - | YTX5L-BS | - | - |
| 500 | 500K4, LC | - | - | - | YB9-B | - |
| 520 | E/XC, M/XC Racing 4-Stroke | 00-02 | - | YTX4L-BS | - | - |
| 520 | E/XC, M/XC Racing 4-Stroke (Opt) | 00-02 | - | YTX5L-BS | - | - |
| 520 | E/XC520 Racing 4S | 00- | YTX4L-BS | YT4L-BS | - | - |
| 525 | EXC Racing | 03- | YTZ5S | - | - | - |
| 525 | MX Desert Racing | 03- | YTZ5S | - | - | - |
| 525 | MXC Racing | 00- | - | YTX5L-BS | - | - |
| 530 | EXC | - | - | YTX5L-BS | - | - |
| 530 | XC-W | - | - | YTX5L-BS | - | - |
| 550 | LC | - | - | - | - | 12N9-4B-1 |
| 620 | Adventure, Duke, LC4 | 96-98 | - | YTX9-BS | - | - |
| 625 | Adventure | 03- | YTZ10S | - | - | - |
| 625 | Adventure R | 00- | - | YTX9-BS | - | - |
| 625 | All SM | 03- | YTZ10S | - | - | - |
| 625 | Supercomp | 98 | - | YTX9-BS | - | - |
| 625 | SXC | 05- | YTZ10S | - | - | - |
| 640 | Adventurer, Duke, RXC LC4 Super Moto | 99-02 | - | YTX9-BS | - | - |
| 640 | Duke II | -99 | - | YTX9-BS | - | - |
| 640 | Duke II Schwarz, LC4, Adventure | 03- | YTZ10S | - | - | - |
| 640 | Duke, E | 96-97 | - | YTX9-BS | - | - |
| 640 | LC4 | -99 | - | YTX9-BS | - | - |
| 640 | LC4 | 03- | YTZ10S | - | - | - |
| 690 | Duke | 09-12 | YTZ10S | - | - | - |

Can't find your vehicle listed?
Visit www.yuasa.com for our latest application data

| CC | Model | Year | High Performance Maintenance Free | Maintenance Free VRLA | YuMicron | Conventional |
|----------------------|-------------------------|-------|-----------------------------------|-----------------------|----------|--------------|
| KTM continued | | | | | | |
| 690 | Duke | 13-16 | - | YTX9-BS | - | - |
| 690 | Euduro | - | YTZ10S | - | - | - |
| 690 | Euduro R | - | YTZ10S | - | - | - |
| 690 | Supermoto | - | YTZ10S | - | - | - |
| 690 | SMC | - | YTZ10S | - | - | - |
| 690 | SMC R | - | YTZ10S | - | - | - |
| 950 | Adventure | 03- | YTZ14S | - | - | - |
| 950 | Superenduro | - | YTZ14S | - | - | - |
| 950 | Supermoto | 03- | YTZ14S | - | - | - |
| 990 | Adventure, R, S | 03- | YTZ14S | - | - | - |
| 990 | SM R, T | - | YTZ14S | - | - | - |
| 990 | Super Duke, R | 03- | YTZ14S | - | - | - |
| 990 | Supermoto | - | YTZ14S | - | - | - |
| 1050 | Adventure | 14- | YTZ14S | - | - | - |
| 1190 | Adventure, R | 13- | YTZ14S | - | - | - |
| 1190 | RC8, R, Track | 09- | YTZ14S | - | - | - |
| 1290 | Super Duke | 14- | - | YTX14-BS | - | - |
| 1290 | Super Adventure | 14- | YTZ14S | - | - | - |
| - | EXC-F | 05- | - | YTX5L-BS | - | - |
| KYMCO | | | | | | |
| 50 | Agility 50 | 09-16 | - | YTX7A-BS | - | - |
| 50 | Calypso50, Cobra, Cross | 99 | - | YTX5L-BS | - | - |
| 50 | CX/CX Super | 00- | - | YTX4L-BS | - | - |
| 50 | CX50, -Curio, -Super | 95-97 | - | YTX4L-BS | - | - |
| 50 | Dink50/LC | 99 | - | YTX5L-BS | - | - |
| 50 | Dj50, Djw50, Djx50 | 97 | YTX4L-BS | YT4L-BS | - | - |
| 50 | Dj50, Djw50, Djx50 | 98- | - | YTX4L-BS | - | - |
| 50 | Djy 50 | - | - | YTX4L-BS | - | - |
| 50 | Fever ZX | 00 | - | YTX5L-BS | - | - |
| 50 | Filly 50 | 99 | - | YTX5L-BS | - | - |
| 50 | FREEWAY 50 | - | - | YTX4L-BS | - | - |
| 50 | GOING 50 | - | - | YTX4L-BS | - | - |
| 50 | Heroism | 95-97 | - | YTX4L-BS | - | - |
| 50 | IDOL 50 | - | - | YTX4L-BS | - | - |
| 50 | JR | - | - | YTX5L-BS | - | - |
| 50 | K12 | 96-97 | - | YTX4L-BS | - | - |
| 50 | KB | 97 | - | YTX4L-BS | - | - |
| 50 | MAN BOY 50 | - | - | YTX4L-BS | - | - |
| 50 | People | 00- | - | YTX5L-BS | - | - |
| 50 | People | 09-12 | YTZ7S | YTX5L-BS | - | - |
| 50 | People S (2T) | - | - | YTX4L-BS | - | - |
| 50 | People S (4T) | - | - | YTX7A-BS | - | - |
| 50 | Racer, Looping, People | 99 | - | YTX5L-BS | - | - |
| 50 | Scout | 97 | YTX4L-BS | YT4L-BS | - | - |
| 50 | Sniper/Sniper DD | 00- | - | YTX4L-BS | - | - |
| 50 | Spacer | 99 | - | YTX5L-BS | - | - |
| 50 | Super 8, 9 | 99 | - | YTX5L-BS | - | - |
| 50 | Super 8 | 09-16 | - | YTX7A-BS | - | - |
| 50 | Super 9 (2T) | - | - | YTX4L-BS | - | - |
| 50 | Super 9 (4T) | - | - | YTX5L-BS | - | - |
| 50 | Top Boy | 97 | - | YTX5L-BS | - | - |
| 50 | VJR 50 | - | YTZ10S | YTX7A-BS | - | - |

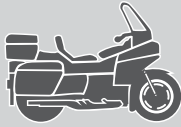

| CC | Model  | Year | High Performance Maintenance Free | Maintenance Free VRLA | YuMicon | Conventional |
|------------------------|---|-------|-----------------------------------|-----------------------|---------|--------------|
| KYMCO continued | | | | | | |
| 50 | Vitality | - | - | YTX5L-BS | - | - |
| 50 | Vitality (2T) | - | - | YTX4L-BS | - | - |
| 50 | Vitality (4T) | - | - | YTX5L-BS | - | - |
| 50 | YUP 50 | - | - | YTX4L-BS | - | - |
| 50 | ZAP 50 | - | - | YTX4L-BS | - | - |
| 50 | ZX Fever | 95-97 | YTX4L-BS | YT4L-BS | - | - |
| 50 | Cherry 50 | - | - | YTX5L-BS | - | - |
| 50 | Kiwi 50 | - | - | YTX5L-BS | - | - |
| 50 | VJR 50 Fi | 11- | - | YTX7A-BS | - | - |
| 50 | Many 50 Fi | 11- | - | YTX7A-BS | - | - |
| 50 | Grand Dink | - | - | YTX4L-BS | - | - |
| 50 | Dink | - | - | YTX5L-BS | - | - |
| 50 | Dink II | - | - | YTX5L-BS | - | - |
| 80 | Filly 80 | 99 | - | YTX5L-BS | - | - |
| 90 | MAN BOY 90 | - | YTZ10S | YTX7A-BS | - | - |
| 100 | AS100 | 99 | - | YTX5L-BS | - | - |
| 100 | Caro 100 | - | - | YTX7A-BS | - | - |
| 100 | GOING 100 | - | YTZ10S | YTX7A-BS | - | - |
| 100 | IDOL 100 | - | YTZ10S | YTX7A-BS | - | - |
| 100 | KB | 97 | - | YTX5L-BS | - | - |
| 100 | Sonner 100 | - | - | YTX7A-BS | - | - |
| 100 | Top Boy | 97 | - | YTX7A-BS | - | - |
| 100 | So Easy | - | - | YTX5L-BS | - | - |
| 100 | So Easy Fi | - | - | YTX7A-BS | - | - |
| 100 | VJR 100 Fi | - | - | YTX7A-BS | - | - |
| 100 | Many 100 Fi | - | - | YTX7A-BS | - | - |
| 100 | Cherry 100 | - | - | YTX5L-BS | - | - |
| 100 | Cherry 100 Fi | 11- | - | YTX7A-BS | - | - |
| 100 | JR 100 | - | - | YTX7A-BS | - | - |
| 100 | JR 100 Fi | - | - | YTX7A-BS | - | - |
| 100 | Kiwi 100 | - | - | YTX7A-BS | - | - |
| 100 | X Mode | 11- | - | YTX7A-BS | - | - |
| 100 | Easy 100 | - | - | YTX5L-BS | - | - |
| 100 | Easy 100 Fi | - | - | YTX7A-BS | - | - |
| 110 | VJR Fi | 11- | - | YTX7A-BS | - | - |
| 110 | Many Fi | 11- | - | YTX7A-BS | - | - |
| 110 | Candy 110 | - | - | YTX7A-BS | - | - |
| 125 | Agility 125 | -16 | - | YTX5L-BS | - | - |
| 125 | B&W125 | 99 | - | YTX9-BS | - | - |
| 125 | Calypso 125 | 99 | - | YTX9-BS | - | - |
| 125 | Cue 125 | - | - | YTX7A-BS | - | - |
| 125 | Dink/LX | 97 | - | YTX9-BS | - | - |
| 125 | Fox Hunt | 96 | - | YTX7A-BS | - | - |
| 125 | Heroism | 95-96 | - | YTX9-BS | - | - |
| 125 | Jockey 125 | 99 | - | YTX7A-BS | - | - |
| 125 | KTR 125 | - | - | - | - | 12N7A-3A |
| 125 | K-XCT | 13-14 | - | YTX9-BS | - | - |
| 125 | Like Fi 125cc | - | - | YTX7A-BS | - | - |
| 125 | Like MMC 125cc | - | - | YTX7A-BS | - | - |
| 125 | Many 125 | - | - | YT7B-BS | - | - |
| 125 | Movie 125 | 99 | - | YTX9-BS | - | - |
| 125 | People 125 | 00 | - | YTX7A-BS | - | - |
| 125 | People S | - | - | YTX7A-BS | - | - |

World number one for motorcycle batteries

| CC | Model | Year | High Performance Maintenance Free | Maintenance Free VRLA | YuMicron | Conventional |
|------------------------|---------------|-------|-----------------------------------|-----------------------|----------|--------------|
| KYMCO continued | | | | | | |
| 125 | People GT | - | - | YT12A-BS | - | - |
| 125 | Spacer | 99 | - | YTX9-BS | - | - |
| 125 | Vivio | - | - | YTX9-BS | - | - |
| 125 | Zing | 99 | - | YTX7A-BS | - | - |
| 125 | Racing 125 | - | - | YTX9-BS | - | - |
| 125 | Jockey 125 | - | - | YTX7A-BS | - | - |
| 125 | Jockey 125 Fi | - | - | YTX9-BS | - | - |
| 125 | V1 125 Fi | 11- | - | YTX7A-BS | - | - |
| 125 | V2 125 | - | - | YTX7A-BS | - | - |
| 125 | G5 125 | - | - | YTX9-BS | - | - |
| 125 | G5 125 Fi | 11- | - | YTX9-BS | - | - |
| 125 | G6 125 Fi | 13-14 | - | YTX9-BS | - | - |
| 125 | G6E 125 | - | - | YTX9-BS | - | - |
| 125 | VP 125 | - | - | YTX7A-BS | - | - |
| 125 | VP 125 Fi | 11- | YTZ10S | TTZ10S | - | - |
| 125 | GP2 125 | - | - | YTX7A-BS | - | - |
| 125 | GP 125 | - | - | YTX7A-BS | - | - |
| 125 | GP 125 Fi | 09 | YTZ10S | TTZ10S | - | - |
| 125 | GP 125 Fi | 10- | - | YTX7A-BS | - | - |
| 125 | Herself | - | - | YTX7A-BS | - | - |
| 125 | Grand Dink | - | - | YTX9-BS | - | - |
| 125 | Dink II | - | - | YTX9-BS | - | - |
| 125 | Downtown | - | - | YT12A-BS | - | - |
| 125 | Quannon | - | - | YT7B-BS | - | - |
| 135 | HX 135 | - | - | - | - | 12N7A-3A |
| 150 | AEXA A 150 | - | - | YTX9-BS | - | - |
| 150 | AIR 150 | - | - | YTX9-BS | - | - |
| 150 | B&W150 | - | - | YTX9-BS | - | - |
| 150 | Dink | - | - | YTX9-BS | - | - |
| 150 | Dink/LX | 97 | - | YTX9-BS | - | - |
| 150 | Grand Dink | - | - | YTX9-BS | - | - |
| 150 | Fox Hunt | 96 | - | YTX7A-BS | - | - |
| 150 | Heroism | 96 | - | YTX9-BS | - | - |
| 150 | Movie | - | - | YTX9-BS | - | - |
| 150 | NSR 150 () | - | - | - | YB3L-A | - |
| 150 | People | 09-12 | - | YTX7A-BS | - | - |
| 150 | RACING 150 | - | - | YTX9-BS | - | - |
| 150 | Spacer | 99 | - | YTX9-BS | - | - |
| 150 | Vivio | - | - | YTX9-BS | - | - |
| 150 | Zing | 99 | - | YTX7A-BS | - | - |
| 150 | Racing 150 | - | - | YTX9-BS | - | - |
| 150 | Racing 150 Fi | - | - | YTX9-BS | - | - |
| 150 | G5 150 | - | - | YTX9-BS | - | - |
| 150 | G5 150 Fi | - | - | YTX9-BS | - | - |
| 150 | G6 150 Fi | - | - | YTX9-BS | - | - |
| 150 | GP150 | - | - | YTX7A-BS | - | - |
| 150 | GP2 150 | - | - | YTX7A-BS | - | - |
| 150 | V1 150 Fi | 11- | - | YTX9-BS | - | - |
| 150 | V2 150 Fi | - | - | YTX9-BS | - | - |
| 150 | EGO 150 | - | - | YTX9-BS | - | - |
| 150 | Quannon 150 | - | - | YT7B-BS | - | - |
| 150 | KTR 150 | - | - | YT9B-BS | - | - |
| 150 | KTR 150 Fi | - | - | - | - | 12N9-4B-2 |
| 150 | Hipster 150 | - | - | YTX7A-BS | - | - |

| CC | Model | Year | High Performance Maintenance Free | Maintenance Free VRLA | YuMicron | Conventional |
|------------------------|--------------------|-------|-----------------------------------|-----------------------|----------|--------------|
| KYMCO continued | | | | | | |
| 150 | Super 8 150 | 09-16 | - | YTX7A-BS | - | - |
| 180 | DINK 180 | - | - | YT12A-BS | - | - |
| 180 | Dink 180i | - | - | YTX12-BS | - | - |
| 180 | Dink 180 Fi | - | - | YTX12-BS | - | - |
| 180 | Racing | - | - | YTX9-BS | - | - |
| 180 | Racing 180 Fi | 12- | - | YT12A-BS | - | - |
| 180 | Racing King | - | - | YT12A-BS | - | - |
| 180 | Racing King 180 Fi | - | - | YT12A-BS | - | - |
| 200 | Dink | 14- | - | YT12A-BS | - | - |
| 200 | Dink II | - | - | YT12A-BS | - | - |
| 200 | Downtown 200 Fi | - | - | YT12A-BS | - | - |
| 200 | Grand Dink | - | - | YT12A-BS | - | - |
| 200 | Nikita 200 Fi | - | - | YT12A-BS | - | - |
| 200 | People S | - | YTZ10S | TTZ10S | - | - |
| 200 | People GT | - | - | YT12A-BS | - | - |
| 200 | K-XCT | 14- | - | YT12A-BS | - | - |
| 250 | B&W250 | - | - | YTX12-BS | - | - |
| 250 | Dink 250 | - | - | YTX12-BS | - | - |
| 250 | People 250 | - | - | YTX12-BS | - | - |
| 250 | People S | - | - | YTX12-BS | - | - |
| 250 | Super-9 | 00 | - | YTX12-BS | - | - |
| 250 | Xciting | - | - | YTX12-BS | - | - |
| 250 | Xciting 250 Fi | - | - | YTX12-BS | - | - |
| 250 | YUP 250 | - | - | YTX12-BS | - | - |
| 250 | EGO 250 | - | - | YTX12-BS | - | - |
| 250 | Venox 250i | - | - | YTX9-BS | - | - |
| 250 | Venox 250 Fi | - | - | YTX9-BS | - | - |
| 250 | Xciting | - | - | YTX12-BS | - | - |
| 250 | Grand Dink | - | - | YTX12-BS | - | - |
| 250 | Grand Dink 250i | 14- | - | YT12A-BS | - | - |
| 250 | Venox | - | - | YTX9-BS | - | - |
| 300 | DINK 300 | - | - | YT12A-BS | - | - |
| 300 | Downtown 300 | -12 | - | YTX12-BS | - | - |
| 300 | Grand Dink 300 i | - | - | YT12A-BS | - | - |
| 300 | K-XCT 300 Fi | 13-14 | - | YT12A-BS | - | - |
| 300 | Nikita 300 Fi | 11- | - | YT12A-BS | - | - |
| 300 | People GT | - | - | YT12A-BS | - | - |
| 300 | Xciting 300 Fi | - | - | YTX12-BS | - | - |
| 300 | Downtown 300 Fi | - | - | YT12A-BS | - | - |
| 300 | Shadow 300 Fi | - | - | YT12A-BS | - | - |
| 400 | Xciting 400 Fi | - | - | YTX14-BS | - | - |
| 500 | Xciting | - | - | YTX14-BS | - | - |
| 500 | Xciting 500i | 09-12 | - | YTX14-BS | - | - |
| 500 | Xciting 500Fi | 09-16 | - | YTX14-BS | - | - |
| 700 | My road | - | - | YTX14-BS | - | - |
| LAVERDA | | | | | | |
| 125 | 125LB | - | - | - | - | 12N5.5-3B |
| 125 | 125LZ (Zundapp) | - | - | - | - | 6N11A-1B |
| 125 | CU Rider | - | - | - | - | 12N5.5-3B |
| 125 | GS Lesmo | - | - | - | - | 12N5.5-3B |
| 150 | Phoenix | - | - | YTX9-BS | - | - |
| 200 | Phoenix | - | - | YTX9-BS | - | - |

Can't find your vehicle listed?
Visit www.yuasa.com for our latest application data

| CC | Model | Year | High Performance Maintenance Free | Maintenance Free VRLA | YuMicron | Conventional |
|---------------------------------|--------------------------|------|-----------------------------------|-----------------------|----------|--------------|
| 350 | 350 | - | - | - | 52515 | - |
| 500 | 500 | - | - | - | 52515 | - |
| 600 | OR Atlas | - | - | - | YB14L-A2 | - |
| 650 | Ghost, Strike | - | - | - | YB14L-A2 | - |
| 668 | Diamante, Ghost | -99 | - | YT19BL-BS | 51814* | - |
| 668 | Ghost Legend, Strike | -99 | - | YT19BL-BS | 51814* | - |
| 750 | 750GTL, SFC, S | -99 | - | YT19BL-BS | 51814* | - |
| 750 | Carenata, Diamante | -99 | - | YT19BL-BS | 51814* | - |
| 750 | Formula | - | - | - | YB4L-B | - |
| 750 | Ghost Strike, Formula | -99 | - | YT19BL-BS | 51814* | - |
| 750 | SF/SFC/GTL/GTS | - | - | - | - | 12N24-3A |
| 750 | Strike | - | - | - | - | 12N24-3A |
| 1000 | 1000RGS | - | - | - | 53030 | - |
| 1200 | 1200 | - | - | - | 53030 | - |
| LEM | | | | | | |
| 50 | Flash | - | - | - | YB4L-B | - |
| 50 | Ghibli | - | - | - | YB4L-B | - |
| LONCIN | | | | | | |
| 110 | LX110-30 II | - | - | - | YB5L-B | - |
| 125 | JL125-4 | - | - | - | YB6L-B | - |
| 150 | LX150-2EV | - | - | - | YB7L-B | - |
| 200 | LX200-2 II | - | - | - | - | 12N7A-3A |
| LUOYANG NORTHERN EK CHOR | | | | | | |
| 110 | DAYANG 110 | - | - | - | YB5L-B | - |
| 125 | DAYANG 125 | - | - | YTX7A-BS | - | - |
| MAICO | | | | | | |
| 125 | GS125, 250TM, 360T | - | - | - | - | B39-6 |
| 250 | CUP | - | - | - | YB5L-B | - |
| 250 | MD250 | - | - | - | YB5L-B | - |
| 250 | TM250, M250 | - | - | - | - | B39-6 |
| 360 | T360 | - | - | - | - | B39-6 |
| 400 | T400 | - | - | - | - | B39-6 |
| 440 | T440 | - | - | - | - | B39-6 |
| 504 | GS504 | - | - | - | - | B39-6 |
| MALAGUTTI | | | | | | |
| 50 | Centro | 94- | - | - | YB4L-B | - |
| 50 | Centro SL/SL Kat | - | - | - | YB5L-B | - |
| 50 | Ciak | 99 | - | - | YB5L-B | - |
| 50 | Colors | - | - | - | YB4L-B | - |
| 50 | CR1 | 96- | - | - | YB4L-B | - |
| 50 | Crosser EL | 98 | - | - | YB4L-B | - |
| 50 | Dune ES | 89 | - | - | YB4L-B | - |
| 50 | Evolution | - | - | - | YB4L-B | - |
| 50 | F10, F12/F12LC Twin Disk | - | - | - | YB4L-B | - |
| 50 | F15 Twin Disk/Digit | - | - | - | YB5L-B | - |
| 50 | F15/F15 Twin Disk | - | - | - | YB4L-B | - |
| 50 | Fifty Top | 91 | - | - | YB4L-B | - |
| 50 | Mistral | - | - | - | YB4L-B | - |

*YT19BL-BS must be used on bikes fitted with ABS

| CC | Model | Year | High Performance Maintenance Free | Maintenance Free VRLA | YuMicron | Conventional |
|----------------------------|------------------|-------|-----------------------------------|-----------------------|----------|--------------|
| MALAGUTTI continued | | | | | | |
| 50 | New Dribbling | - | - | - | YB4L-B | - |
| 50 | Phantom F.12 | 94- | - | - | YB4L-B | - |
| 50 | RST | - | - | - | YB4L-B | - |
| 50 | Top | - | - | - | YB4L-B | - |
| 50 | Yesterday, Euro | 99 | - | - | YB4L-B | - |
| 100 | Ciak | 99 | - | - | YB5L-B | - |
| 100 | F12 | - | - | YTX5L-BS | - | - |
| 100 | Phantom F.12 | 99 | YTX5L-BS | YT5L-BS | - | - |
| 125 | F18 | - | - | - | YB9-B | - |
| 125 | Madison | 00 | - | - | YB9-B | - |
| 125 | Runner VS, Rally | 87- | - | - | YB3L-A | - |
| 125 | Runner, R | -86 | - | - | - | 6N6-3B |
| 150 | Ciak | - | - | - | YB9-B | - |
| 150 | F18 | - | - | - | YB9-B | - |
| 150 | Madison | - | - | - | YB9-B | - |
| 180 | Madison | - | - | - | YB9-B | - |
| 250 | Madison | 00 | - | - | YB9-B | - |
| 250 | Phantom Max | 04 | - | YTX12-BS | - | - |
| 400 | Madison K | 02-04 | - | - | YB12AL-A | - |
| 500 | Spider Max | 04-05 | - | - | YB14L-A2 | - |
| MALANCA | | | | | | |
| 125 | 1252CE | - | - | - | - | 6N11A-1B |
| 125 | 1250B One | - | - | - | - | 12N5.5-4B |
| 125 | Mark 125 | - | - | - | - | 12N5.5-4B |
| 150 | 150GT | - | - | - | - | 6N11A-1B |
| MATCHLESS | | | | | | |
| 250 | 250 | - | - | - | - | B38-6A |
| 350 | 350 | - | - | - | - | B38-6A |
| 500 | 500 | - | - | - | - | B38-6A |
| 650 | (6V) | - | - | - | - | B38-6A |
| 650 | (12V) | - | - | - | YB7L-B | - |
| 750 | 750 | - | - | - | YB7L-B | - |
| MBK | | | | | | |
| 50 | Active | - | - | - | YB4L-B | - |
| 50 | Booster | 93-96 | - | - | YB4L-B | - |
| 50 | Booster NG | 96-97 | - | - | YB4L-B | - |
| 50 | Booster Road | 95 | - | - | YB4L-B | - |
| 50 | Booster Rocket | 96-97 | - | - | YB4L-B | - |
| 50 | Booster Spirit | -99 | - | - | YB4L-B | - |
| 50 | Booster Track | -99 | - | - | YB4L-B | - |
| 50 | CTS/SS | - | - | - | YB4L-B | - |
| 50 | Equalis | -99 | - | - | YB4L-B | - |
| 50 | Evolis | 93-97 | - | - | YB4L-B | - |
| 50 | Fizz | 95-96 | - | - | YB4L-B | - |
| 50 | Forte | 96-97 | - | - | YB4L-B | - |
| 50 | Nitro | -99 | - | - | YB4L-B | - |
| 50 | Ovetto | -99 | - | - | YB4L-B | - |
| 50 | Sorriso | - | - | - | YB4L-B | - |
| 50 | Target | - | - | - | YB4L-B | - |
| 50 | X-Limit DT50 | 97 | - | - | YB3L-A | - |

World number one for motorcycle batteries

| CC | Model | Year | High Performance Maintenance Free | Maintenance Free VRLA | YuMicron | Conventional |
|----------------------|---------------------------------|-------|-----------------------------------|-----------------------|----------|--------------|
| MBK continued | | | | | | |
| 80 | Evolis | - | - | - | YB4L-B | - |
| 100 | Booster | 95-96 | - | YTX5L-BS | - | - |
| 100 | Nitro | - | - | YTX4L-BS | - | - |
| 100 | Ovetto | - | - | YTX4L-BS | - | - |
| 125 | Doodo | - | - | - | YB7L-B | - |
| 125 | Flame | 95-97 | - | YTX7A-BS | - | - |
| 125 | Flame R | -98 | - | YTX7A-BS | - | - |
| 125 | Skyliner 125 | - | - | - | YB7L-B2 | 12N7-3B |
| 125 | XC Flame/Flame R | - | - | YTX7A-BS | - | - |
| 125 | YZFR 125 | 14- | - | - | - | 12N5.5-4A |
| 150 | Skyliner | - | - | - | YB7L-B | - |
| 150 | Vertex | - | - | YTX7A-BS | - | - |
| 250 | Skyliner 250 | 00 | - | YT7B-BS | - | - |
| 300 | Kilibre | 04 | - | YTX9-BS | - | - |
| 660 | XT660R | - | - | YT9B-BS | - | - |
| MORINI | | | | | | |
| 125 | Corsaro | - | - | - | - | 6N11A-1B |
| 125 | Country | - | - | - | - | 6N11A-1B |
| 150 | 150SS | - | - | - | - | 6N11A-1B |
| 175 | Turiso, Spor | - | - | - | - | B49-6 |
| 350 | Coguardo | - | - | - | YB18L-A | - |
| 350 | Dart | - | - | - | YB14L-A2 | - |
| 350 | Excalibur | - | - | - | YB18L-A | - |
| 350 | Kanguro | - | - | - | YB18L-A | - |
| 350 | New York | - | - | - | YB18L-A | - |
| 350 | Sport bicil. | - | - | - | - | 12N9-3B |
| 350 | Sport bicil. (Electric-Starter) | - | - | - | YB18L-A | - |
| 500 | Enduro | - | - | - | - | 6N2-2A |
| 500 | Turbo | - | - | - | YB18L-A | - |
| 501 | Camel | - | - | - | YB18L-A | - |
| 501 | Coguardo | - | - | - | YB18L-A | - |
| 501 | Excalibur | - | - | - | YB18L-A | - |
| 501 | New York | - | - | - | YB18L-A | - |
| 1200 | 9 1/2 | - | - | YTX20CH-BS | - | - |
| 1200 | Sport | - | - | YTX20CH-BS | - | - |
| 1200 | Scrambler | - | - | YTX20CH-BS | - | - |
| 1200 | Granpasso | - | - | YTX20CH-BS | - | - |
| 1200 | Corsaro | - | - | YTX20CH-BS | - | - |
| 1200 | Corsaro Veloce | - | - | YTX20CH-BS | - | - |
| 1200 | Corsaro Avio | - | - | YTX20CH-BS | - | - |
| MOTO GUZZI | | | | | | |
| 125 | Bicilindrico | - | - | - | - | 6N11A-3A |
| 125 | Bizylinder | - | - | - | - | 6N11A-3A |
| 125 | Custom | - | - | - | - | 12N9-4B-1 |
| 125 | Stornello Scrambler | - | - | - | - | B38-6A |
| 125 | Stornello Sport | - | - | - | - | B39-6 |
| 125 | TT | - | - | - | - | 12N5.5-4A |
| 160 | Stornello Scrambler | - | - | - | - | B38-6A |
| 175 | Lodola | - | - | - | - | B49-6 |
| 200 | Galletto | - | - | - | - | 12N24-3A |
| 200 | Motocarro Ercolino | - | - | - | - | B38-6A |

| CC | Model | Year | High Performance Maintenance Free | Maintenance Free VRLA | YuMicron | Conventional |
|-----------------------------|---------------------|-------|-----------------------------------|-----------------------|------------|--------------|
| MOTO GUZZI continued | | | | | | |
| 250 | 4 cylinder | - | - | - | YB12A-A | - |
| 250 | Bicilindrico | - | - | - | - | 6N11A-3A |
| 250 | Bizylinder | - | - | - | - | 6N11A-3A |
| 350 | Florida | - | - | - | YB18L-A | - |
| 350 | GTS (4 cylinder) | - | - | - | 52515 | - |
| 350 | Nevada/Nevda club | - | - | - | YB18L-A | - |
| 350 | NTX | - | - | - | YB18L-A | - |
| 350 | V35 | - | - | - | 53030 | - |
| 350 | V35 Custom | 82-86 | - | - | YB18L-A | - |
| 350 | V35 II | 81-86 | - | - | 53030 | - |
| 350 | V35 Imola/V35 Monza | - | - | - | 53030 | - |
| 350 | V35/V35 GT/V35 C | - | - | - | 53030 | - |
| 400 | GTS (4 cylinder) | - | - | - | 52515 | - |
| 500 | Falcone | - | - | - | - | B38-6A |
| 500 | Falcone u.t. | - | - | - | YB18L-A | - |
| 500 | V50 | - | - | - | 53030 | - |
| 500 | V50 Custom | 81-86 | - | - | YB18L-A | - |
| 500 | V50 III | 81-86 | - | - | 53030 | - |
| 500 | V50 Imola/V50 Monza | - | - | - | 53030 | - |
| 500 | V50/V50C | - | - | - | 53030 | - |
| 650 | Nevada | 91-93 | - | - | Y50-N18L-A | - |
| 650 | Nevada N.T | 94-98 | - | - | 53030 | - |
| 650 | NTX | - | - | - | YB18L-A | - |
| 650 | V65 | - | - | - | 53030 | - |
| 650 | V65 Custom | 82-86 | - | - | YB18L-A | - |
| 650 | V65 Florida | - | - | - | YB18L-A | - |
| 650 | V65 Florida | 86-93 | - | - | 53030 | - |
| 650 | V65 GT | 87-94 | - | - | 53030 | - |
| 650 | V65 Lario | 84-87 | - | - | 53030 | - |
| 650 | V65 Sport | 82-87 | - | - | 53030 | - |
| 750 | Breva | 05- | YTX14AHL-BS | - | YB14L-A2 | - |
| 750 | Nevada | 05-08 | - | - | YB14L-A2 | - |
| 750 | Nevada | 08 | YTX14AHL-BS | - | - | - |
| 750 | Nevada, Club | 00-02 | - | - | YB18L-A | - |
| 750 | Nevada, Club | 08 | YTX14AHL-BS | - | - | - |
| 750 | Nevada 750 Classic | - | YTX14AHL-BS | - | YB14L-A2 | - |
| 750 | Nevada 750 S.E. 07 | - | YTX14AHL-BS | - | YB14L-A2 | - |
| 750 | V7 Classic | - | YTX14AHL-BS | - | YB14L-A2 | - |
| 750 | NTX | 88-92 | - | - | YB18L-A | - |
| 750 | Strada | - | - | - | YB18L-A | - |
| 750 | Strada | 93-96 | - | - | 53030 | - |
| 750 | Targa | 90-93 | - | - | 53030 | - |
| 750 | V7 | - | - | - | 53030 | - |
| 750 | V7 | - | - | - | YB14L-A2 | - |
| 750 | V7 | 08 | YTX14AHL-BS | - | - | - |
| 750 | V7 | 15 | - | YTX14-BS | - | - |
| 750 | V75 | 95-97 | - | - | YB18L-A | - |
| 750 | V75 | 08 | YTX14AHL-BS | - | - | - |
| 750 | V7 Racer 2012 | 12- | - | YTX14-BS | - | - |
| 750 | V7 Stone | 13- | - | YTX14-BS | - | - |
| 750 | V7 Special | 13- | - | YTX14-BS | - | - |
| 850 | Breva | - | YTX20CH-BS | - | - | - |
| 850 | Griso | - | YTX20CH-BS | - | - | - |

Can't find your vehicle listed?
Visit www.yuasa.com for our latest application data

| CC | Model | Year | High Performance Maintenance Free | Maintenance Free VRLA | YuMicron | Conventional |
|-----------------------------|---|-------|-----------------------------------|-----------------------|------------|--------------|
| MOTO GUZZI continued | | | | | | |
| 850 | Le Man | - | - | - | 53030 | - |
| 850 | Norge | - | YTX20CH-BS | - | - | - |
| 850 | T3, T4, T5 | - | - | - | 53030 | - |
| 850 | T3, T4, T5 III | 81-88 | - | - | 53030 | - |
| 850 | V9 | 16 | - | YTX14-BS | - | - |
| 936 | Bellagio | - | - | YTX20L-BS | - | - |
| 938 | Bellagio | 13- | - | YTX20CH-BS | - | - |
| 1000 | 1000NT | - | - | - | 53030 | - |
| 1000 | 1000S | 94-98 | - | - | 53030 | - |
| 1000 | California II/III | 82-98 | - | - | 53030 | - |
| 1000 | Convert | - | - | - | 53030 | - |
| 1000 | Daytona, RS | 92-98 | - | - | 53030 | - |
| 1000 | G5/Convert | - | - | - | 53030 | - |
| 1000 | GT | - | - | - | 53030 | - |
| 1000 | Le Mans | - | - | - | 53030 | - |
| 1000 | Le Mans III | 85-93 | - | - | 53030 | - |
| 1000 | Mille | - | - | - | 53030 | - |
| 1000 | Mille GT | 87-93 | - | - | 53030 | - |
| 1000 | Quota | - | - | - | 53030 | - |
| 1000 | Quota | 92-95 | - | - | Y50-N18L-A | - |
| 1000 | SP/California/III | - | - | - | 53030 | - |
| 1000 | SP/II/III | 77-91 | - | - | 53030 | - |
| 1000 | Strada | 93-96 | - | - | 53030 | - |
| 1000 | V10 Centauro Sport/GT/SP | 97-00 | - | - | 53030 | - |
| 1000 | V10 Centauro Sport, GT | 00- | - | YTX15L-BS | - | - |
| 1064 | California Classic | - | - | YTX20L-BS | - | - |
| 1064 | California Vintage | - | - | YTX20L-BS | - | - |
| 1100 | 1100 Sport/1 | 94-01 | - | - | 53030 | - |
| 1100 | Breva | - | - | YTX20L-BS | - | - |
| 1100 | Breva | - | YTX20CH-BS | - | - | - |
| 1100 | Breva ABS | -07 | YTX20CH-BS | - | - | - |
| 1100 | Breva, Griso | 05-06 | YTX20CH-BS | - | - | - |
| 1100 | California | - | - | YTX20L-BS | - | - |
| 1100 | California (CA only) | 03-05 | - | YTX15L-BS | - | - |
| 1100 | California EV, Stone | 99-04 | - | - | 53030 | - |
| 1100 | California, Special, Jackal, Breva, Griso | - | YTX20CH-BS | - | - | - |
| 1100 | Griso | - | YTX20CH-BS | - | - | - |
| 1100 | Jackal | - | - | - | 53030 | - |
| 1100 | Quota 1100 ES | 99-02 | - | YTX15L-BS | - | - |
| 1100 | Quota1100ES | 00-01 | - | - | 53030 | - |
| 1100 | Sport 1100i | 97-99 | - | YTX15L-BS | - | - |
| 1100 | Stone, EV | 94-05 | - | - | 53030 | - |
| 1100 | V11 Ballabgio | - | - | YTX15L-BS | - | - |
| 1100 | V11 Ballabgio | - | - | YTX20L-BS | - | - |
| 1100 | V11 Bassa | 99-00 | - | - | 53030 | - |
| 1100 | V11 Cafe Sports | - | - | YTX15L-BS | - | - |
| 1100 | V11 EV | 98-99 | - | - | 53030 | - |
| 1100 | V11 Le Mans | - | - | - | 53030 | - |
| 1100 | V11 Le Mans Rosso Corsa | - | - | YTX15L-BS | - | - |
| 1100 | V11 Le Mans, Sport | 99-05 | - | YTX15L-BS | - | - |
| 1100 | V11 Sport | 99- | - | - | 53030 | - |
| 1200 | Griso 1200 8V | 13- | YTX20CH-BS | - | - | - |

| CC | Model | Year | High Performance Maintenance Free | Maintenance Free VRLA | YuMicron | Conventional |
|-----------------------------|----------------------|-------|-----------------------------------|-----------------------|------------|--------------|
| MOTO GUZZI continued | | | | | | |
| 1200 | Norge 1200 T | - | YTX20CH-BS | - | - | - |
| 1200 | Norge GT8V | 13- | - | YTX20-BS | - | - |
| 1200 | Sport | - | YTX20CH-BS | - | - | - |
| 1200 | Sport ABS | - | YTX20CH-BS | - | - | - |
| 1200 | Stelvio 4V | - | YTX20CH-BS | - | - | - |
| 1200 | Stelvio NTX 1200 8V | 13- | YTX20CH-BS | - | - | - |
| 1200 | Breva 1200 | - | YTX20CH-BS | - | - | - |
| 1200 | Breva 1200 ABS | - | YTX20CH-BS | - | - | - |
| 1256 | MGS-01 Corsa | - | - | YTX20L-BS | - | - |
| 1380 | California | 13- | YTX20H-BS | YTX20-BS | - | - |
| 1380 | Eldorado | 16 | YTX20CH-BS | - | - | - |
| 1400 | Audace | 16 | YTX20CH-BS | - | - | - |
| 1400 | MGX-21 | 16 | - | YTX20-BS | - | - |
| MOTOTRANS | | | | | | |
| - | 250 Strada | - | - | - | - | 12N12A-4A-1 |
| - | 350 Forsa | - | - | - | Y50-N18L-A | - |
| - | 350 Vento | - | - | - | - | 12N12A-4A-1 |
| - | 500 Desmo | - | - | - | YB14L-A2 | - |
| - | 500 Twin | - | - | - | Y50-N18L-A | - |
| MOTRON | | | | | | |
| 50 | Compact Racing RZ1 | - | - | - | YB4L-B | - |
| 50 | Invader | - | - | - | YB4L-B | - |
| 50 | Spike | - | - | - | YB4L-B | - |
| 50 | Sting | - | - | - | YB4L-B | - |
| 50 | Syncro | - | - | - | YB4L-B | - |
| 50 | Thunder | - | - | - | YB4L-B | - |
| 50 | XLE | - | - | - | YB4L-B | - |
| MuZ | | | | | | |
| 125 | All Models | All | - | - | YB9L-A2 | - |
| 660 | Skorpion | 95-01 | - | - | YB9L-A2 | - |
| MV AGUSTA | | | | | | |
| 675 | F3, Brutale | 16 | YTZ10S | - | - | - |
| 750 | F4, Brutale | 00-08 | YTZ10S | - | - | - |
| 750 | F4, Brutale | 04- | YTZ10S | - | - | - |
| 750 | F4, Serie Oro | - | - | - | 53030 | - |
| 800 | Brutale | 16 | YTZ10S | - | - | - |
| 910 | Brutale | 06-08 | YTZ10S | - | - | - |
| 1000 | Brutale 1078RR, 1090 | 09-16 | YTZ10S | - | - | - |
| 1000 | F4 | 05-16 | YTZ10S | - | - | - |
| 1000 | F4 1000 | - | - | - | Y60-N24L-A | - |
| MZ | | | | | | |
| 125 | 125ES, ETS | - | - | - | - | 6N11A-1B |
| 125 | 125ETZ | - | - | - | - | 12N9-3B |
| 125 | 125TS | - | - | - | - | 6N11A-1B |
| 125 | 150ETZ | - | - | - | - | 12N9-3B |
| 125 | Roadstar | 93-94 | - | - | YB5L-B | - |
| 125 | Sazson Sport Star | 93-97 | - | - | YB5L-B | - |

World number one for motorcycle batteries

| CC | Model | Year | High Performance Maintenance Free | Maintenance Free VRLA | YuMicron | Conventional |
|---------------------------|-----------------------------|-------|-----------------------------------|-----------------------|----------|--------------|
| MZ continued | | | | | | |
| 150 | TS150 | - | - | - | - | 6N11A-1B |
| 250 | ETS250 | - | - | - | - | 6N11A-1B |
| 250 | ETZ250 | - | - | - | - | 12N9-3B |
| 250 | TS250 | - | - | - | - | 6N11A-1B |
| 251/301 | Saxson Fun, Tour | 93-94 | - | - | YB5L-B | - |
| 500 | Green Star | 97 | - | - | YB14L-A2 | - |
| 500 | Red Star | 97 | - | - | YB14L-A2 | - |
| 500 | Saxon Fun | 93 | - | - | YB14L-A2 | - |
| 500 | Saxson Country | 93-97 | - | - | YB14L-A2 | - |
| 500 | Silver Star Classic | 93-96 | - | - | YB14L-A2 | - |
| 500 | Tour | 93-94 | - | - | YB14L-A2 | - |
| 660 | Skorpion Classic | 97 | - | - | YB9L-B | - |
| 660 | Skorpion Race Replica | 95-96 | - | - | YB9L-B | - |
| 660 | Skorpion Replica | 97 | - | - | YB9L-B | - |
| 660 | Skorpion Sport | 94-97 | - | - | YB9L-B | - |
| 660 | Skorpion Tour | 94-97 | - | - | YB9L-B | - |
| 660 | Skorpion Traveller | 97 | - | - | YB9L-B | - |
| NANJING JINCHENG | | | | | | |
| - | SJ110 | - | - | - | YB5L-B | - |
| NORTON | | | | | | |
| 350 | 350 Navigator | - | - | - | - | 6N11A-1B |
| 750 | 750 Ranger Commando | - | - | - | YB9-B | - |
| 850 | 850 Commando, Commando (75) | - | YTX14AHL-BS | - | - | - |
| OZBIKE | | | | | | |
| All Models | All | - | YTX5L-BS | - | - | - |
| PANDA MOTOR SPORTS | | | | | | |
| 50 | Com-ute | 96-02 | - | - | - | 6N4-2A |
| 50 | Cub | 96-99 | - | YTX4L-BS | - | - |
| 50 | Fun Rider | 96-02 | - | - | - | 6N2-2A |
| 50 | Retro | 01-02 | - | - | YB7-A | - |
| 70 | Trail Rider | 99-02 | - | YTX4L-BS | - | - |
| PEUGEOT | | | | | | |
| 25 | Fox LA | 95-97 | - | - | YB4L-B | - |
| 50 | Buxy | 95-97 | - | - | YB4L-B | - |
| 50 | Buxy RS | 96-97 | - | - | YB4L-B | - |
| 50 | Elyseo | 98 | - | - | YB4L-B | - |
| 50 | Elystar TDS | 03- | - | - | YB4L-B | - |
| 50 | Fox Lux | 95-97 | - | - | YB4L-B | - |
| 50 | Liverty | - | - | - | YB4L-B | - |
| 50 | Looxor | 01- | - | - | YB4L-B | - |
| 50 | Looxor TDS | 02- | - | - | YB7L-B | - |
| 50 | Rapido/Rapido3 | 01- | - | - | YB4L-B | - |
| 50 | SCLI Metropolis | 01- | - | - | YB4L-B | - |
| 50 | Speedake | 01- | - | - | YB4L-B | - |
| 50 | Speedfight/LC | 97-99 | - | - | YB4L-B | - |
| 50 | Speedfight 2 | 00- | - | - | YB4L-B | - |
| 50 | Squab | 96-97 | - | - | YB4L-B | - |

| CC | Model | Year | High Performance Maintenance Free | Maintenance Free VRLA | YuMicron | Conventional |
|--------------------------|--------------------------------|-------|-----------------------------------|-----------------------|----------|--------------|
| PEUGEOT continued | | | | | | |
| 50 | ST | 01- | - | - | YB4L-B | - |
| 50 | SV Blue Star | 97 | - | - | YB4L-B | - |
| 50 | SV Junior | 93-96 | - | - | YB4L-B | - |
| 50 | SV/SV Geo | 93-97 | - | - | YB4L-B | - |
| 50 | Trekker Road/Off Road | 99 | - | - | YB4L-B | - |
| 50 | Vivacity | 99 | - | - | YB4L-B | - |
| 50 | X-Fight | - | - | - | YB4L-B | - |
| 50 | Zenith | 95-96 | - | - | YB4L-B | - |
| 50 | Jet Force | 03 | - | - | YB4L-B | - |
| 50 | Ludix | 04 | - | - | YB4L-B | - |
| 80 | SV80 | 93-96 | - | - | YB5L-B | - |
| 100 | Elyseo | 99 | - | - | YB7L-B | - |
| 100 | Elyseo | 01- | - | YTX5L-BS | - | - |
| 100 | Looxor | 01- | - | YTX5L-BS | - | - |
| 100 | Speedfighter | 98- | - | YTX5L-BS | - | - |
| 100 | SV | -97 | - | - | YB5L-B | - |
| 100 | Trekker | 98- | - | YTX5L-BS | - | - |
| 100 | Vivacity | 99- | - | YTX5L-BS | - | - |
| 100 | X-Fight | 01- | - | YTX5L-BS | - | - |
| 100 | Zenith | 01- | - | - | YB4L-B | - |
| 105 | Ciclomotore (Electric-Starter) | 01- | - | - | YB4L-B | - |
| 125 | Jet Force | 03 | - | - | YB12AL-A | - |
| 125 | Jet Force Compressor | 03 | - | - | YB12AL-A | - |
| 125 | Satelis | 05 | - | - | YB12AL-A | - |
| 125 | Satelis Compressor | 07 | - | - | YB14L-A2 | - |
| 125 | Geopolis | 05 | - | - | YB12AL-A | - |
| 125 | Elyseo | - | - | - | YB7-A | - |
| 125 | Elystar | 02- | - | - | YB7-A | - |
| 125 | SV125 | 93-97 | - | - | YB5L-B | - |
| 125 | CityStar | 11 | - | - | YB12AL-A | - |
| 125 | Django | 14- | - | YTX7A-BS | - | - |
| 125 | 8F. QP125. | - | - | YTX7A-BS | - | - |
| 200 | QP200T | - | - | YTX14-BS | - | - |
| 125 | ET 4 | 04 | - | - | YB9-B | - |
| 150 | Elyseo | 98 | - | - | YB7-A | - |
| 150 | Elystar | 02- | - | - | YB7-A | - |
| 200 | GILERA NEW RUNNER 200 VXR | 08 | - | - | YB9-B | - |
| 250 | ST/SV | 01- | - | YTX12-BS | - | - |
| 250 | Satelis | 06 | - | - | YB12AL-A | - |
| 250 | Geopolis | 05 | - | - | YB12AL-A | - |
| 400 | Satelis | 07 | - | YTX12-BS | - | - |
| 500 | Satelis | 07 | - | YTX12-BS | - | - |
| PGO | | | | | | |
| 25 | Comet | 95-97 | YTX4L-BS | YT4L-BS | - | - |
| 25 | Galaxy | 97 | YTX4L-BS | YT4L-BS | - | - |
| 25 | Mega | 97 | YTX4L-BS | YT4L-BS | - | - |
| 50 | Big Max | 95-96 | - | - | YB4L-B | - |
| 50 | Big Max Sport | 96-97 | YTX4L-BS | YT4L-BS | - | - |
| 50 | Comet | 93-96 | YTX4L-BS | YT4L-BS | - | - |
| 50 | Comet Junior | 94-97 | YTX4L-BS | YT4L-BS | - | - |
| 50 | Galaxy | 93-97 | YTX4L-BS | YT4L-BS | - | - |
| 50 | Mega | 97 | YTX4L-BS | YT4L-BS | - | - |

Can't find your vehicle listed?
Visit www.yuasa.com for our latest application data

| CC | Model | Year | High Performance Maintenance Free | Maintenance Free VRLA | YuMicron | Conventional |
|----------------------|------------------------------|-------|-----------------------------------|-----------------------|----------|--------------|
| PGO continued | | | | | | |
| 50 | Star-Star II | 93-96 | - | - | YB4L-B | - |
| 50 | Tornado | 97 | YTX4L-BS | YT4L-BS | - | - |
| 80 | Star | 93-96 | YTX4L-BS | YT4L-BS | - | - |
| 90 | Big Max | 97 | YTX4L-BS | YT4L-BS | - | - |
| 90 | Galaxy | 94-97 | YTX4L-BS | YT4L-BS | - | - |
| 90 | Tornado | 97 | YTX4L-BS | YT4L-BS | - | - |
| PIAGGIO | | | | | | |
| 25 | Free, FL | 94-98 | - | - | YB4L-B | - |
| 25 | Velofax | -98 | - | - | YB4L-B | - |
| 25 | Zip | 94-98 | - | - | YB4L-B | - |
| 50 | D-M.B.NRG 2T H2O POW. | - | - | - | YB9-B | - |
| 50 | Diesis | - | - | - | YB4L-B | - |
| 50 | DNA | - | - | YTX4L-BS | - | - |
| 50 | Easy Moving | - | - | - | YB4L-B | - |
| 50 | FANCY 50 | - | - | - | YB5L-B | - |
| 50 | Fly | 09-12 | - | - | YB4L-B | - |
| 50 | Fly 2T | 13- | - | - | YB4L-B | - |
| 50 | Fly 4T | - | - | - | YB9-B | - |
| 50 | Free 50 Poste | - | - | YTX4L-BS | - | - |
| 50 | Free PTT | - | - | YTX4L-BS | - | - |
| 50 | Free, FD | 94-99 | - | - | YB4L-B | - |
| 50 | Free | - | - | YTX4L-BS | - | - |
| 50 | GPR 50 | - | - | YTX4L-BS | - | - |
| 50 | ICE 50 | - | - | YTX4L-BS | - | - |
| 50 | Liberty | -99 | - | - | YB4L-B | - |
| 50 | Liberty 2T, 2T RST | - | - | YTX4L-BS | YB4L-B | - |
| 50 | Liberty 2T Sport | - | - | - | YB4L-B | - |
| 50 | Liberty 4T, 4T RST | - | - | - | YB9-B | - |
| 50 | Liberty 50 2 Tempi | - | - | YTX4L-BS | - | - |
| 50 | Liberty 504T PTT Belgio | - | - | - | YB9-B | - |
| 50 | Liberty 504T PTT(D) | - | - | - | YB9-B | - |
| 50 | Liberty 50 4T PTT Portogallo | - | - | - | YB9-B | - |
| 50 | Liberty 504T PTT Slovenia | - | - | - | YB9-B | - |
| 50 | Liberty 504T RST PTT Fran | - | - | - | YB9-B | - |
| 50 | Liberty 504T PTT RST Ital | - | - | - | YB9-B | - |
| 50 | Liberty 504T RST Europa | - | - | - | YB9-B | - |
| 50 | Liberty IGET 3V | 16 | - | YTX7L-BS | - | - |
| 50 | Liberty IGET 3V 25km/h | 16 | - | YTX7L-BS | - | - |
| 50 | Liberty PTT | - | - | YTX4L-BS | - | - |
| 50 | LX50 | 10-12 | - | - | YB9-B | - |
| 50 | New Fly 50 4T | 13- | - | YTX7L-BS | - | - |
| 50 | NRG | 94-98 | - | - | YB4L-B | - |
| 50 | NRG | - | - | YTX4L-BS | - | - |
| 50 | NRG 2T H2O Power | - | - | - | YB9-B | - |
| 50 | NRG Extreme, DT, DD | -99 | - | YTX4L-BS | - | - |
| 50 | NRG MC2 | 96-98 | - | - | YB4L-B | - |
| 50 | NRG MC3 | 01- | - | YTX4L-BS | YB4L-B | - |
| 50 | NRG Power | - | - | - | YB4L-B | - |
| 50 | NRG Power DD | - | - | - | YB4L-B | - |
| 50 | NRG Power DT | - | - | - | YB4L-B | - |
| 50 | NRG Power D/T | - | - | - | YB9-B | - |
| 50 | NRG Power PureJet | - | - | - | YB9-B | - |

| CC | Model | Year | High Performance Maintenance Free | Maintenance Free VRLA | YuMicron | Conventional |
|--------------------------|--|-------|-----------------------------------|-----------------------|----------|--------------|
| PIAGGIO continued | | | | | | |
| 50 | NRG PureJet | 03- | - | - | YB9-B | - |
| 50 | NTT | - | - | - | YB4L-B | - |
| 50 | PK 50 | - | - | - | YB4L-B | - |
| 50 | Quartz | 93-98 | - | - | YB4L-B | - |
| 50 | RCR | - | - | - | YB4L-B | - |
| 50 | Runner 50 IN. Replica UK | - | - | - | YB9-B | - |
| 50 | Runner Iniez. PureJet | - | - | - | YB9-B | - |
| 50 | Runner Iniez. Europ | - | - | - | YB9-B | - |
| 50 | Runner Iniez. UK | - | - | - | YB9-B | - |
| 50 | Runner Poggiali | - | - | YTX4L-BS | - | - |
| 50 | Runner Replica | - | - | - | YB9-B | - |
| 50 | Runner SP, DD, FL | - | - | - | YB4L-B | - |
| 50 | Runner SP Race | - | - | - | YB4L-B | - |
| 50 | Runner SP SC | - | - | - | YB4L-B | - |
| 50 | SALUTE 50 | - | - | - | YB5L-B | - |
| 50 | Scatto | - | - | - | YB4L-B | - |
| 50 | Siera, RST | 93-98 | - | - | YB4L-B | - |
| 50 | SMT | - | - | - | YB4L-B | - |
| 50 | SP 50 | 10-12 | - | - | YB4L-B | - |
| 50 | SR 50 PureJet | - | - | - | YB9-B | - |
| 50 | Stalker 50 | - | - | YTX4L-BS | YB4L-B | - |
| 50 | Stalker Naked | - | - | - | YB4L-B | - |
| 50 | Storm 50 | 95-96 | - | YTX4L-BS | YB4L-B | - |
| 50 | Typhoon 50 | 94-99 | - | YTX4L-BS | YB4L-B | - |
| 50 | Typhoon 50 2T | 13- | - | - | YB9-B | - |
| 50 | Typhoon 50 USA | - | - | - | YB9-B | - |
| 50 | Typhoon 50 Canada | - | - | - | YB9-B | - |
| 50 | Velofax | -98 | - | - | YB4L-B | - |
| 50 | Vespa 4T | - | - | YTX4L-BS | YB9-B | - |
| 50 | Vespa Elestar | - | - | - | - | 6N11A-3A |
| 50 | Vespa ET2 Iniez | - | - | YTX5L-BS | YB5L-B | - |
| 50 | Vespa ET2, Injection | 98- | - | YTX4L-BS | YB4L-B | - |
| 50 | Vespa ET4 | - | - | - | YB9-B | - |
| 50 | Vespa ET4 Euro 2 | - | - | - | YB9-B | - |
| 50 | Vespa LX 2T | - | - | YTX4L-BS | YB4L-B | - |
| 50 | Vespa LX 4T, LXV 2T | - | - | - | YB9-B | - |
| 50 | M.B. Vespa 25 KM/H LX (B-NL-D-DK) | 08 | - | - | YB9-B | - |
| 50 | M.B. Vespa 25 KM/H LX (B-NL) Vers. Spec. | 08 | - | - | YB9-B | - |
| 50 | M.B. Vespa 50/2T LX Germania | 08 | - | - | YB9-B | - |
| 50 | M.B. Vespa 50/2T LX Europa | 08 | - | - | YB9-B | - |
| 50 | M.B. Vespa 50 LXS Budget | 07 | - | - | YB9-B | - |
| 50 | M.B. Vespa 50 LX E.3 Svizzera | 08 | - | - | YB9-B | - |
| 50 | M.B. Vespa 50/2T LX 30 Km/h DK | 08 | - | - | YB9-B | - |
| 50 | Vespa PK FL/FL2 | - | - | - | YB7-A | - |
| 50 | Vespa PK Marce A.EL | - | - | YTX5L-BS | YB5L-B | - |
| 50 | Vespa PK N, S | - | - | - | YB7-A | - |
| 50 | Vespa PK Rush | - | - | - | YB7-A | - |
| 50 | Vespa PK/HP | - | - | - | YB7-A | - |
| 50 | Vespa S 50 2T | 13- | - | - | YB4L-B | - |
| 50 | Vespa S 50 4T | 13- | - | - | YB9-B | - |
| 50 | Vespa PX | - | - | - | YB9-B | - |
| 50 | Zip 4T | 02- | - | YTX9-BS | - | - |
| 50 | Zip 4 Tempi Euro 2 | - | - | YTX7L-BS | - | - |

World number one for motorcycle batteries

| CC | Model | Year | High Performance Maintenance Free | Maintenance Free VRLA | YuMicron | Conventional |
|--------------------------|----------------------------|-------|-----------------------------------|-----------------------|----------|--------------|
| PIAGGIO continued | | | | | | |
| 50 | Zip Catalyzed. 2T | 02- | - | YTX4L-BS | - | - |
| 50 | Zip FR, RST, SP 2T H2O | - | - | - | YB4L-B | - |
| 50 | Zip SP (Euro 2) | 06-08 | - | - | YB4L-B | - |
| 50 | Zip | - | - | YTX4L-BS | YB4L-B | - |
| 50 | Zip, Fast Rider | - | - | - | YB4L-B | - |
| 80 | P80X | - | - | - | - | 12N5.5-3B |
| 80 | PK80 | - | - | - | - | 12N5.5-3B |
| 80 | PK80 S, XL | - | - | - | YB7-A | - |
| 80 | PX80 E | - | - | - | YB9-B | YB7-A |
| 80 | PX80 E Lusso | 90-96 | - | - | YB7-A | - |
| 80 | Sfera | 93-95 | - | - | YB7-A | - |
| 100 | Diesis | 07- | - | YTX4L-BS | - | - |
| 100 | Free 100 4T | - | - | YTX7L-BS | - | - |
| 125 | Beverly | 00- | - | YT12B-BS | - | - |
| 125 | Beverly, Sport (Euro 3) | - | - | YTX12-BS | - | - |
| 125 | Beverly 125 GT, 4T | - | - | - | YB9-B | - |
| 125 | Beverly 125 EUR | - | - | - | YB9-B | - |
| 125 | Beverly 125 UK | - | - | - | YB9-B | - |
| 125 | Carnaby 124 4T | - | - | YTX12-BS | - | - |
| 125 | Cosa, CL, FL, X | -95 | - | - | YB7-A | - |
| 125 | CORSA MATIC | - | - | YTX5L-BS | - | - |
| 125 | DNA 125 | - | - | - | YB9-B | - |
| 125 | DNA 125 4T | - | - | - | YB10L-B | - |
| 125 | Excutive | 00- | - | - | YB9-B | - |
| 125 | Fly | - | - | - | YB9-B | - |
| 125 | Granturismo | - | - | YTX12-BS | - | - |
| 125 | Hexagon | - | - | - | YB9-B | - |
| 125 | Hexagon 4T | - | - | - | YB10L-BP | - |
| 125 | Hexagon GTX | - | - | - | YB10L-B | - |
| 125 | Hexagon LX4 | 00- | - | YTX12-BS | - | - |
| 125 | Hexagon, Hexagon LX, RST | -99 | - | - | YB9-B | - |
| 125 | IMP. ELETTR. V. 125 ET4 | - | - | - | YB9-B | - |
| 125 | Liberty | 99 | - | - | YB9-B | - |
| 125 | Liberty 125 3V | 13- | - | YTX7L-BS | - | - |
| 125 | Liberty 4T, Sport | 08 | - | YTX12-BS | - | - |
| 125 | Liberty IGET E3 ABS | 16 | - | YTX7L-BS | - | - |
| 125 | LX 125 | - | - | - | YB9-B | 12N9-4B-1 |
| 125 | LXV 125 | - | - | YTX12-BS | - | - |
| 125 | Medley | 16- | - | YTX7L-BS | - | - |
| 125 | MP3 | 07- | - | YTX14-BS | - | - |
| 125 | New Fly 125 3V | 13- | - | YT12B-BS | - | - |
| 125 | Nexus 125 | - | - | YTX12-BS | - | - |
| 125 | RS 125 ES, Racing | - | - | - | YB9-B | - |
| 125 | Runner 125 | 10-12 | - | - | YB9-B | - |
| 125 | Runner 125 VX 4T | 07 | - | YTX12-BS | YB9-B | - |
| 125 | Runner, DT, DD, 4T, VX | - | - | - | YB9-B | - |
| 125 | RUNNER 125 E2 | - | - | - | YB9-B | - |
| 125 | M. Base Liberty 125 RST | - | - | - | YB9-B | - |
| 125 | Vespa PX 125 E2 Belgio 05- | - | - | - | YB9-B | - |
| 125 | Vespa PX 125 E2 | - | - | - | YB9-B | - |
| 125 | S125 | - | - | - | YB9-B | 12N9-4B-1 |
| 125 | Sfera RST | - | - | YTX9-BS | YB9-B | - |
| 125 | Sfera 4T | 96-98 | - | YTX7L-BS | YB7-A | - |

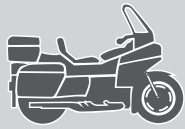
| CC | Model  | Year | High Performance Maintenance Free | Maintenance Free VRLA | YuMicron | Conventional |
|--------------------------|---|-------|-----------------------------------|-----------------------|----------|--------------|
| PIAGGIO continued | | | | | | |
| 125 | Skipper | - | - | - | YB7-A | - |
| 125 | Skipper 125 2T | - | - | - | YB9-B | - |
| 125 | Skipper 4T | - | - | - | YB9-B | - |
| 125 | Skipper LX/ST4T | 99 | - | - | YB9-B | - |
| 125 | SKR | 94-98 | - | - | YB7-A | - |
| 125 | ST4 Leader | 00- | - | YTX9-BS | - | - |
| 125 | Superhexagon GTX | 00- | - | YTX12-BS | - | - |
| 125 | New Fly 125 3V | 13- | - | YT12B-BS | - | - |
| 125 | Typhoon, X, XR | 96-99 | - | - | YB9-B | - |
| 125 | V. 125 ET4 Euro2 | - | - | - | YB9-B | - |
| 125 | V.125 ET4 Euro2 Europa | - | - | - | YB9-B | - |
| 125 | Vespa ET4, LX | 96-00 | - | - | YB9-B | - |
| 125 | Vespa ETS | - | - | - | YB7-A | - |
| 125 | Vespa Granturismo | - | - | - | YB9-B | - |
| 125 | Vespa GT H20, UK | - | - | - | YB9-B | - |
| 125 | New Fly 125 3V | 13- | - | YT12B-BS | - | - |
| 125 | Vespa GTV 4T Navy, LXV | - | - | YTX12-BS | - | - |
| 125 | Vespa LX 125 3V | 13- | - | YTX7L-BS | - | - |
| 125 | Vespa LXV 125 4T | - | - | YTX12-BS | - | - |
| 125 | Vespa P125X | -98 | - | - | - | 12N5.5-3B |
| 125 | Vespa PK-S, -FL, -XL | - | - | - | YB7-A | - |
| 125 | Vespa PX | 13- | - | - | YB9-B | - |
| 125 | Vespa PX E | -98 | - | - | YB9-B | - |
| 125 | Vespa PX S | -98 | - | - | YB7-A | - |
| 125 | Vespa S 125 3V | 13- | - | YTX7L-BS | - | - |
| 125 | Vespa Sprint | - | - | - | - | B39-6 |
| 125 | Vespa T5 | - | - | - | YB7-A | - |
| 125 | X7 (Euro 3) | 08 | - | YTX12-BS | - | - |
| 125 | X8 Premium | - | - | YTX14-BS | - | - |
| 125 | X8 Street, Premium (Euro 2) | - | - | - | YB10L-BP | - |
| 125 | X9, Evolution | 00- | - | - | YB10L-B | YB9-B |
| 125 | Zip 4T | 00- | - | YTX9-BS | - | - |
| 125 | X8 125 Premium (Euro 3) | - | - | YTX14-BS | - | - |
| 125 | Beverly 125 Tourer (Euro 3) | - | - | YTX12-BS | - | - |
| 125 | Vespa GTV 125 4T Navy (Euro 3) | - | - | YTX12-BS | - | - |
| 125 | Vespa LXV 125 4T Navy (Euro 3) | - | - | YTX12-BS | - | - |
| 125 | Runner 125 VX 4T -ST- (Euro 3) | - | - | YTX12-BS | - | - |
| 125 | X Evo 125 (Euro 3) | - | - | YTX14-BS | - | - |
| 125 | X10 125 | 12- | - | YTX12-BS | - | - |
| 150 | Cosa CL, X | - | - | - | YB7-A | - |
| 150 | Excutive | - | - | - | YB9-B | - |
| 150 | Fly 150 | 09-12 | - | - | YB9-B | - |
| 150 | Hexagon | 95-97 | - | - | YB9-B | - |
| 150 | Liberty | 00- | - | - | YB9-B | - |
| 150 | Liberty 150 3V | 13- | - | YTX7L-BS | - | - |
| 150 | Liberty 4T, Sport | - | - | YTX12-BS | - | - |
| 150 | Liberty IGET E3 ABS | 16 | - | YTX7L-BS | - | - |
| 150 | LX150 | 10 | - | - | YB9-B | 12N9-4B-1 |
| 150 | LX150 MATIC | 12 | - | YTX7L-BS | - | - |
| 150 | Medley | 16- | - | YTX7L-BS | - | - |
| 150 | Skipper | - | - | - | YB7-A | - |
| 150 | Skipper 150 2T | - | - | - | YB9-B | - |
| 150 | Skipper LX/ST 4T | -99 | - | YTX9-BS | YB9-B | - |

Can't find your vehicle listed?
Visit www.yuasa.com for our latest application data

| CC | Model | Year | High Performance Maintenance Free | Maintenance Free VRLA | YuMicron | Conventional |
|--------------------------|-------------------------------|------|-----------------------------------|-----------------------|----------|--------------|
| PIAGGIO continued | | | | | | |
| 150 | Typhoon 150 | - | - | - | YB9-B | - |
| 150 | Vespa ET4 (sealed) | 99- | - | YTX9-BS | - | - |
| 150 | Vespa ET4, LX, PX | - | - | - | YB9-B | - |
| 150 | Vespa GL | - | - | - | - | B39-6 |
| 150 | Vespa GS | - | - | - | - | B49-6 |
| 150 | Vespa LX 4T | - | - | YTX12-BS | - | - |
| 150 | Vespa PX X | - | - | - | YB7-A | - |
| 150 | Vespa Sprint | - | - | - | - | B49-6 |
| 150 | Skipper 150cc | - | - | - | YB9-B | - |
| 150 | Fly 150 | - | - | - | YB9-B | - |
| 150 | Fly 150 4T USA | - | - | - | YB9-B | - |
| 150 | S150 | - | - | - | YB9-B | 12N9-4B-1 |
| 150 | Vespa 150 LX 3V | 13- | - | YTX7L-BS | - | - |
| 150 | Vespa 151 ET4 Euro2 Europa | - | - | - | YB9-B | - |
| 150 | Vespa 150 LX Canada 2007 | - | - | - | YB9-B | - |
| 150 | Vespa 150 LX USA 2007 | - | - | - | YB9-B | - |
| 150 | Liberty 150cc. | - | - | YT12A-BS | - | - |
| 150 | Liberty Sport 150cc. | - | - | YT12A-BS | - | - |
| 150 | Liberty 150 4T (Euro 3) | - | - | YTX12-BS | - | - |
| 150 | Liberty 150 4T Sport (Euro 3) | - | - | YTX12-BS | - | - |
| 150 | PX-150 EXCEL | 90 | - | - | - | 12N10-3B |
| 150 | Vespa PX 151 E2 | - | - | - | YB9-B | - |
| 150 | Vespa PX 150 USA | - | - | - | YB9-B | - |
| 150 | Vespa PX 150 | - | - | - | YB9-B | 12N9-4B-1 |
| 150 | X8 Street (Euro 2) | - | - | - | YB10L-BP | - |
| 180 | DNA 180 | - | - | - | YB9-B | - |
| 180 | DNA 180 4T | - | - | - | YB10L-BP | - |
| 180 | Hexagon 4T | - | - | - | YB10L-BP | - |
| 180 | Hexagon LXT | -99 | - | - | YB10L-B | - |
| 180 | Hexagon LXT | 00- | - | YTX12-BS | - | - |
| 180 | Runner 180 2T | - | - | - | YB9-B | - |
| 180 | Runner 180 4T | 07- | - | YTX12-BS | - | - |
| 180 | Superhexagon GTX | 01- | - | YTX12-BS | - | - |
| 180 | Vespa SS | 01- | - | - | - | B49-6 |
| 180 | X9 | 01- | - | - | YB10L-BP | - |
| 200 | Beverly | - | - | YT12B-BS | YB10L-BP | - |
| 200 | Beverly 200 | 07- | - | YTX12-BS | - | - |
| 200 | Carnaby 4T | - | - | YTX14-BS | - | - |
| 200 | Cosa | -96 | - | - | YB9-B | - |
| 200 | Granturismo L | - | - | - | YB10L-BP | - |
| 200 | Liberty | - | - | YTX12-BS | YB10L-BP | - |
| 200 | Liberty 200 4T | - | - | YTX12-BS | YB10L-BP | - |
| 200 | Liberty 200 4T Sport | 07 | - | YTX12-BS | - | - |
| 200 | Runner 4T | - | - | - | YB10L-BP | - |
| 200 | Runner VXR 4T, RST | - | - | YTX12-BS | YB10L-BP | - |
| 200 | Vespa Granturismo | - | - | - | YB10L-BP | - |
| 200 | Vespa GT200 | - | - | - | YB10L-BP | - |
| 200 | Vespa P E | - | - | - | YB7-A | - |
| 200 | Vespa PX E Lusso | -98 | - | - | YB9-B | YB7-A |
| 200 | X8 | - | - | - | YB10L-BP | - |
| 200 | X9 Evolution | - | - | - | YB10L-BP | - |
| 200 | Motore Go-Kart 200cc | - | - | YTX7L-BS | - | - |
| 200 | Vespa PX 200 | - | - | - | YB9-B | - |

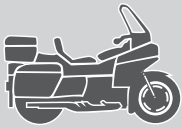
| CC | Model  | Year | High Performance Maintenance Free | Maintenance Free VRLA | YuMicron | Conventional |
|--------------------------|---|-------|-----------------------------------|-----------------------|----------|--------------|
| PIAGGIO continued | | | | | | |
| 200 | Liberty 200cc. | - | - | YT12A-BS | - | - |
| 200 | Carnaby 200 4T (Euro 3) (2007-08) | - | - | YTX14-BS | - | - |
| 200 | Runner 200 VXR 4T -ST- (Euro 3) | 10-12 | - | YTX12-BS | - | - |
| 250 | Beverly, Cruiser, Tourer | - | - | YTX14-BS | - | - |
| 250 | Beverly, RST, Euro 3 | - | - | - | YB10L-BP | - |
| 250 | Carnaby 4T ie | - | - | YTX14-BS | - | - |
| 250 | GTS250 | 10 | YTX14H-BS | YTX14-BS | - | - |
| 250 | GTV250 | 10 | YTX14H-BS | YTX14-BS | - | - |
| 250 | Hexagon | 99 | - | - | YB10L-BP | - |
| 250 | Hexagon | 98 | - | - | YB9-B | - |
| 250 | Hexagon GT | 00- | - | YTX12-BS | - | - |
| 250 | MP3 | 07-12 | - | YTX14-BS | - | - |
| 250 | Nexus, Euro 3 | - | - | YTX14-BS | - | - |
| 250 | Nexus, SP Euro 3 | - | - | YTX14-BS | YB14L-A2 | - |
| 250 | Superhexagon GTX | 00 | - | - | YB10L-B | - |
| 250 | Superhexagon GTX | 01-03 | - | YTX12-BS | - | - |
| 250 | Superhexagon GTX | 03- | - | - | YB10L-BP | - |
| 250 | Vespa GTS, GTV, ie 60 | - | - | - | YB10L-BP | - |
| 250 | Vespa GTV ie Navy | - | - | YTX14-BS | - | - |
| 250 | X Evo | - | - | YTX14-BS | - | - |
| 250 | X7 ie | 08 | - | YTX14-BS | - | - |
| 250 | X8 | - | - | - | YB10L-BP | - |
| 250 | X8 ie | - | - | YTX14-BS | - | - |
| 250 | X9 Evolution | 01- | - | YTX12-BS | YB10L-B | - |
| 250 | MP3 250 | - | - | YTX14-BS | - | - |
| 250 | X9 250cc. | - | - | - | YB14L-A2 | - |
| 250 | Nexus 250cc. | - | - | - | YB14L-A2 | - |
| 250 | Beverly 250 | - | - | YTX14-BS | - | - |
| 250 | X8 250 ie | - | - | YTX14-BS | - | - |
| 250 | Beverly 250 (Euro 3) (MIC 2007) | - | - | YTX14-BS | - | - |
| 250 | Carnaby 250 4T ie (Euro 3) | - | - | YTX14-BS | - | - |
| 250 | X Evo 250 (Euro 3) | - | - | YTX14-BS | - | - |
| 250 | Nexus 250 (Euro 3) (2007) | - | - | YTX14-BS | - | - |
| 250 | X7 250 ie (Euro 3) | - | - | YTX14-BS | - | - |
| 250 | Beverly 250 Tourer (Euro 3) | - | - | YTX14-BS | - | - |
| 250 | Vespa GTV 250 ie Navy | - | - | YTX14-BS | - | - |
| 250 | Beverly 250 Cruiser (Euro 3) | - | - | YTX14-BS | - | - |
| 300 | Beverly | 13- | - | YTX12-BS | - | - |
| 300 | GTS300 | 10-12 | YTX14H-BS | YTX14-BS | - | - |
| 300 | MP3 | 13- | - | YTX14-BS | - | - |
| 300 | MP3 Hybrid | 13- | - | YTX14-BS | - | - |
| 300 | Nexus 300 ie (Euro 3) | - | - | YTX14-BS | - | - |
| 300 | Nexus ie | - | - | YTX14-BS | - | - |
| 300 | Vespa GTS | 13- | - | YTX12-BS | - | - |
| 300 | Vespa GTS ie Super | - | - | YTX14-BS | - | - |
| 300 | Vespa GTS Super | 13- | - | YTX12-BS | - | - |
| 300 | X7 Evo | 13- | - | YTX12-BS | - | - |
| 300 | Yourban | 13- | - | YTX14-BS | - | - |
| 300 | MP3 300 LT ABS | 16 | GYZ16H | - | - | - |
| 330 | X10 350 | - | - | YTX12-BS | - | - |
| 350 | Beverly Sports Touring | 13- | - | YTX12-BS | - | - |
| 400 | Beverly 400 Euro 3 | - | - | - | YB10L-BP | - |
| 400 | Beverly ie Tourer | - | - | YTX14-BS | - | - |

World number one for motorcycle batteries

| CC | Model | Year | High Performance Maintenance Free | Maintenance Free VRLA | YuMicron | Conventional |
|--------------------------|--------------------------------------|-------|-----------------------------------|-----------------------|----------|--------------|
| PIAGGIO continued | | | | | | |
| 400 | MP3 | - | - | YTX14-BS | - | - |
| 400 | X Evo | - | - | YTX14-BS | - | - |
| 400 | X8 ie, Euro 3 | - | - | YTX14-BS | - | - |
| 400 | X8, Euro 3 | - | - | - | YB10L-BP | - |
| 401 | X Evo 400 (Euro 3) | - | - | YTX14-BS | - | - |
| 401 | X8 400 ie (Euro 3) | - | - | YTX14-BS | - | - |
| 400 | Beverly 400 ie (Euro 3) | - | - | YTX14-BS | - | - |
| 400 | Beverly 400 ie Tourer (Euro 3) | - | - | YTX14-BS | - | - |
| 400 | MP3 400cc | 08-12 | YTX14H-BS | YTX14-BS | - | - |
| 493 | X10 500 | - | - | YTX12-BS | - | - |
| 500 | Beverly, Cruiser, Euro 3 | - | - | YTX14-BS | - | - |
| 500 | Beverly, Euro 3 | - | - | - | YB10L-BP | - |
| 500 | BV500 | 08-12 | YTX14H-BS | YTX14-BS | - | - |
| 500 | MP3 | 08-16 | YTX14H-BS | YTX14-BS | - | - |
| 500 | Nexus, Euro 3 | - | - | - | YB14L-A2 | - |
| 500 | X9 Evolution | 01- | - | - | YB14L-A2 | - |
| 500 | X9 Evolution USA | - | - | YTX14-BS | - | - |
| 500 | Beverly 500 (Euro 3) | - | - | YTX14-BS | - | - |
| 500 | X9 500cc. | - | - | - | YB14L-A2 | - |
| 500 | Nexus 500cc. | - | - | - | YB14L-A2 | - |
| 500 | Beverly 500 Cruiser (Euro 3) | - | - | YTX14-BS | - | - |
| 502 | Beverly 500 Cruiser (Euro 3) | - | - | YTX14-BS | - | - |
| 500 | X9 500cc | - | - | YTX16-BS | - | - |
| 500 | Fuoco 500cc | 10-12 | YTX20CH-BS | YTX16-BS | - | - |
| - | Vespa 946 | 13- | - | YTX12-BS | - | - |
| POLARIS VICTORY | | | | | | |
| 1507 | V92C, DC Classic, Deluxe Cruiser | 98-04 | YTX20HL-BS | YTX20L-BS | - | - |
| 1507 | V92SC Sport Cruiser | 00-01 | YTX20HL-BS | YTX20L-BS | - | - |
| 1507 | V92TC Touring Cruiser | 02-06 | YTX20HL-BS | YTX20L-BS | - | - |
| 1507 | Vegas, Kingpin, 8-ball, Hammer | 03-05 | YTX20HL-BS | YTX20L-BS | - | - |
| 1634 | Vegas, Kingpin, 8-ball, Hammer (-08) | 06-10 | YTX20HL (WC) | - | - | - |
| 1731 | All models | 08-16 | YTX20HL (WC) | - | - | - |
| PUCH | | | | | | |
| - | Cobra 80 | - | - | - | - | B39-6 |
| - | Cobra GTL, Daytona N50, Monza | - | - | - | - | B39-6 |
| - | Lido SL50, Lido Vario | - | - | - | YB4L-B | - |
| - | Monza GP, Monza GX, Monza X | - | - | - | - | B39-6 |
| QIANJIANG | | | | | | |
| 50 | B01 | - | YTX4L-BS | YT4L-BS | - | - |
| 50 | QJ36-A | - | - | - | YB4L-B | - |
| 50 | QJ50T, QJ50T-2 | - | - | - | YB4L-B | - |
| 50 | QJ50T-2A | - | YTX4L-BS | YT4L-BS | - | - |
| 50 | T08/B01 | - | - | YT4L-BS | - | - |
| 50 | QJ50T-8 | - | - | YTX5L-BS | - | - |
| 50 | T08 | - | YTX4L-BS | YT4L-BS | - | - |
| 100 | QJ110-6 | - | - | - | YB5L-B | - |
| 100 | T12 | - | - | YTX7L-BS | - | - |
| 125 | QJ125 | - | - | YTX7A-BS | - | 12N7-4A |
| 125 | QJ125J | - | - | - | - | 12N9-4B-1 |

| CC | Model | Year | High Performance Maintenance Free | Maintenance Free VRLA | YuMicron | Conventional |
|----------------------------|---------------------------|-------|-----------------------------------|-----------------------|----------|--------------|
| QIANJIANG continued | | | | | | |
| 125 | QJ125T | - | - | YTX7A-BS | - | - |
| 125 | QJ125T-3F | - | - | YTX7A-BS | - | - |
| 125 | QJ125T-27C | - | - | YTX7A-BS | - | - |
| 125 | QJ125T-30A | - | - | YTX7L-BS | - | - |
| 150 | QJ150T | 07- | - | YTX7A-BS | - | - |
| 150 | QJ150-26 | - | - | - | - | 12N7-4A |
| 250 | QJ250-3 | - | - | - | - | 12N9-4B-1 |
| 250 | QJ250T | 07- | - | YTX9-BS | - | - |
| RIZZATO | | | | | | |
| 50 | Byte AT10 | - | - | - | YB4L-B | - |
| 50 | Carosello | - | - | - | YB4L-B | - |
| 50 | Hacker AT12, LC/Racing | - | - | - | YB4L-B | - |
| ROYAL ENFIELD | | | | | | |
| 350 | All Electric Start Models | 00-03 | YTX14AHL-BS | - | - | - |
| 350 | All Kick-start Models | 95-99 | - | - | YB7-A | - |
| 350 | All Kick-start Models | 00-03 | - | - | YB5L-B | - |
| 500 | Bullet Electra | 11- | YTX14AHL-BS | - | - | - |
| SYM | | | | | | |
| 50 | Cinderella | 89 | - | YTX7A-BS | - | - |
| 50 | DD | - | - | YTX4L-BS | - | - |
| 50 | Fiddle | 75-77 | - | YTX4L-BS | - | - |
| 50 | Fiddle | 10-12 | - | YTX7A-BS | - | - |
| 50 | Jet | 79-81 | - | YTX4L-BS | - | - |
| 50 | JetEuro 50 | 10-12 | YTZ7S | - | - | - |
| 50 | Jungle | 89 | - | YTX4L-BS | - | - |
| 50 | Mask | - | - | YTX5L-BS | - | - |
| 50 | Mio | 10-12 | - | YTX7A-BS | - | - |
| 50 | Reddevil | 75-77 | - | YTX4L-BS | - | - |
| 50 | Superfancy | 79-81 | - | YTX4L-BS | - | - |
| 50 | Wind 50 | - | YTZ7S | TTZ7S | - | - |
| 100 | Bonus | - | - | - | YB5L-B | - |
| 100 | Cinderella | 99-01 | - | YTX7A-BS | - | - |
| 100 | Woo 100 | 13-14 | YTZ10S | TTZ10S | - | - |
| 100 | Jet | 75-77 | - | YTX5L-BS | - | - |
| 100 | Mio | - | - | YTX7A-BS | - | - |
| 100 | Wind 100 | - | YTZ7S | TTZ7S | - | - |
| 100 | Wo Wow 100 | - | - | - | YB5L-B | - |
| 110 | Magic | - | - | - | YB5L-B | - |
| 110 | Rvi | - | - | - | YB5L-B | - |
| 110 | mii 110 | - | YTZ10S | TTZ10S | - | - |
| 110 | New mii 110 | 14- | - | YTX7A-BS | - | - |
| 110 | RX 110 | - | YTZ10S | TTZ10S | - | - |
| 110 | WOWOW | 14- | - | TTZ7S | - | - |
| 115 | IRX 115 | 14- | - | YTX7A-BS | - | - |
| 125 | Attila | 99-00 | - | YTX7A-BS | - | - |
| 125 | Husky | 89 | - | YTX7L-BS | - | - |
| 125 | Newduke | 00-01 | - | YTX7A-BS | - | - |
| 125 | Shark | - | - | YTX9-BS | - | - |
| 125 | Superduke | 00-01 | - | YTX7A-BS | - | - |

Can't find your vehicle listed?
Visit www.yuasa.com for our latest application data

| CC | Model | Year | High Performance Maintenance Free | Maintenance Free VRLA | YuMicron | Conventional |
|------------------------|-----------------------------|-------|-----------------------------------|-----------------------|----------|--------------|
| SYM continued | | | | | | |
| 125 | GR125 EFI | - | YTZ10S | TTZ10S | - | - |
| 125 | GT125 EFI, EVO | 12- | - | YTX7A-BS | - | - |
| 125 | Jet Power 125 | 13-14 | YTZ10S | TTZ10S | - | - |
| 125 | Jet power Evo | - | YTZ10S | TTZ10S | - | - |
| 125 | GT 125 EFI | - | YTZ10S | TTZ10S | - | - |
| 125 | GT 125 EVO | 13-14 | YTZ10S | TTZ10S | - | - |
| 125 | GT 125 Super | 14- | - | YTX7A-BS | - | - |
| 125 | GT Super 2 | 14- | - | YTX7A-BS | - | - |
| 125 | Wild Wolf 125 | -13 | YTZ10S | TTZ10S | - | - |
| 125 | Wild Wolf 125 | 14- | - | - | - | 12N7A-3A |
| 125 | Wild Wolf Legend 125 | - | YTZ10S | TTZ10S | - | - |
| 125 | Wild Wolf Legend R 125 | - | YTZ10S | TTZ10S | - | - |
| 125 | Wolf 125 | - | YTZ10S | TTZ10S | - | - |
| 125 | Wolf R125 | - | YTZ10S | TTZ10S | - | - |
| 125 | Z1 125 | - | YTZ10S | TTZ10S | - | - |
| 150 | Attila | 00-01 | - | YTX7A-BS | - | - |
| 150 | Joyride | - | - | YTX9-BS | - | - |
| 150 | Shark | - | - | YTX9-BS | - | - |
| 150 | Super Duke | 96 - | - | YTX9-BS | - | - |
| 150 | VS/EXCEL | - | - | YTX9-BS | - | - |
| 150 | GT 150 | 13-14 | YTZ10S | TTZ10S | - | - |
| 150 | New Fighter | - | YTZ10S | TTZ10S | - | - |
| 150 | Fighter 6th | 14- | YTZ10S | TTZ10S | - | - |
| 150 | Fighter 150 | - | YTZ10S | TTZ10S | - | - |
| 150 | Golden Wolf 150 | - | YTZ10S | TTZ10S | - | - |
| 150 | Wild Wolf Legend R 150 | - | YTZ10S | TTZ10S | - | - |
| 150 | Wolf 150 | - | YTZ10S | TTZ10S | - | - |
| 150 | Wolf Classic | 14- | - | - | - | 12N7A-3A |
| 150 | Wolf R150 | - | YTZ10S | TTZ10S | - | - |
| 150 | T1 | 13-14 | - | YTX9-BS | - | - |
| 180 | RV 180 | - | - | YTX9-BS | - | - |
| 180 | RV 180 Euro | - | - | YTX9-BS | - | - |
| 200 | HD | 10-12 | - | YTX9-BS | - | - |
| 200 | Joyride | - | - | YTX9-BS | - | - |
| 250 | RV 250 | 10-14 | - | YTX12-BS | - | - |
| 250 | GTS | - | - | YTX12-BS | - | - |
| 250 | T2 250 | 13-14 | - | YT12A-BS | - | - |
| 300 | SB300 | - | YTZ10S | TTZ10S | - | - |
| 300 | SB300CR | - | YTZ10S | TTZ10S | - | - |
| 300 | T3 | 14- | - | YT12A-BS | - | - |
| 300 | GTS300i | -13 | YTZ14S | TTZ14S | - | - |
| 300 | GTS300i | 14- | - | YT12A-BS | - | - |
| 300 | RV 270 | 14- | - | YTX12-BS | - | - |
| 400 | MAXSYM | - | YTZ14S | TTZ14S | - | - |
| 400 | MAXSYM400i | 14- | YTZ14S | TTZ14S | - | - |
| 600 | MAXSYM600i | - | YTZ14S | TTZ14S | - | - |
| SHANGHAI YAMAHA | | | | | | |
| - | ES4 (for Brazil) | - | - | YTX7L-BS | - | - |
| SIMSON | | | | | | |
| 50 | Albatros | 97 | - | - | - | 12N5.5-3B |
| 50 | Albatros (Electric-Starter) | 97 | - | - | YB5L-B | - |



| CC | Model | Year | High Performance Maintenance Free | Maintenance Free VRLA | YuMicron | Conventional |
|-------------------------|----------------------------------|-------|-----------------------------------|-----------------------|----------|--------------|
| SIMSON continued | | | | | | |
| 50 | Classic | 96-97 | - | - | - | 12N5.5-3B |
| 50 | S51/1 B, C, E | - | - | - | - | 12N5.5-3B |
| 50 | S53 | 93-95 | - | - | - | 12N5.5-3B |
| 50 | SD CT, CTE | 95 | - | - | - | 12N5.5-3B |
| 50 | SR50 1B, 1C | 93-95 | - | - | - | 12N5.5-3B |
| 50 | SR50 2CE (Electric-Starter) | 93 | - | - | YB5L-B | - |
| 50 | SR50 CC | 94 | - | - | - | 12N5.5-3B |
| 50 | SR50 CCE (Electric-Starter) | 94 | - | - | YB5L-B | - |
| 50 | SR50 M, XC, XG | 94-95 | - | - | - | 12N5.5-3B |
| 50 | SR50 XCE, XGE (Electric-Starter) | 95 | - | - | YB5L-B | - |
| 80 | Classic | 96-97 | - | - | - | 12N5.5-3B |
| 80 | S83 | 93-95 | - | - | - | 12N5.5-3B |
| 80 | SR80 1B, 1C, CC | 93-95 | - | - | - | 12N5.5-3B |
| 80 | SR80 2CE (Electric-Starter) | 93 | - | - | YB5L-B | - |
| 80 | SR80 CCE (Electric-Starter) | 94 | - | - | YB5L-B | - |
| 80 | SR80 XCE, XGE | 95 | - | - | YB5L-B | - |
| SUNDIRO HONDA | | | | | | |
| 50 | SDH50QT 16 | - | - | - | YB4L-B | - |
| 50 | Today | - | - | YTX4L-BS | - | - |
| 100 | SDH100-41 | - | - | - | YB5L-B | - |
| 100 | WAVE | - | - | - | YB5L-B | - |
| 100 | 100-6B/6G | - | - | YTX7A-BS | - | - |
| 125 | 125 | - | - | - | YB6L-B | - |
| 125 | 125T-2D / 8D | - | - | YTX7A-BS | - | - |
| 125 | SDH125 | - | YTX7A-BS | YTX7L-BS | - | 12N9-4B-1 |
| 125 | SDH125-6 | - | - | - | - | 12N7A-3A |
| 125 | SDH125-7B | - | - | - | YB6L-B | - |
| SUZUKI | | | | | | |
| 50 | A50KM | 92 | - | - | - | 6N4-2A-4 |
| 50 | AC50, AS50 | 71 | - | - | - | 6N4-2A |
| 50 | AD50 | 91-95 | YTX4L-BS | YT4L-BS | - | - |
| 50 | Address 50 | -97 | YTX4L-BS | YT4L-BS | - | - |
| 50 | Address V 50 | 08- | - | YT4L-BS | - | - |
| 50 | AE50, 50M | 91-95 | YTX4L-BS | YT4L-BS | - | - |
| 50 | AG50T | 95 | YTX4L-BS | YT4L-BS | - | - |
| 50 | AH50 | 92-95 | YTX4L-BS | YT4L-BS | - | - |
| 50 | AJ50 | 95 | YTX4L-BS | YT4L-BS | - | - |
| 50 | AJ50 ZGS | -02 | - | YT4B-BS | - | - |
| 50 | AP50, R7 | 94- | YTX4L-BS | YT4L-BS | - | - |
| 50 | AY50, W, WR Katana | -98 | - | YT4B-BS | - | - |
| 50 | AZ50 | 06 | - | YT4B-BS | - | - |
| 50 | AZ50 (Lets II ZZ) | -02 | - | YT4B-BS | - | - |
| 50 | CP50 | 85-95 | - | YTX4L-BS | - | - |
| 50 | DR-Z50 | 08- | - | YT4B-BS | - | - |
| 50 | F50, F50R | 71 | - | - | - | 6N4-2A |
| 50 | FA50 Shuttle | 80-91 | - | - | - | 6N2-2A-4 |
| 50 | FB50, M | 91-95 | YTX4L-BS | YT4L-BS | - | - |
| 50 | FE50 | - | - | YTX4L-BS | - | - |
| 50 | FS50, FZ50 | 79-83 | - | - | - | 6N4-2A |
| 50 | GS50 | - | - | YTX4L-BS | - | - |
| 50 | GT50E, K, KE, U | 77-80 | - | - | - | 6N4B-2A |

World number one for motorcycle batteries

| CC | Model | Year | High Performance Maintenance Free | Maintenance Free VRLA | YuMicron | Conventional |
|-------------------------|------------------------------|-------|-----------------------------------|-----------------------|----------|--------------|
| SUZUKI continued | | | | | | |
| 50 | Katana 50LC | 97 | YTX4L-BS | YT4L-BS | - | - |
| 50 | LetOs 4, Pallet, Basket | 04-15 | - | YT4L-BS | - | - |
| 50 | OR50 | 79-80 | - | - | - | 6N4B-2A |
| 50 | Birdie 50 | 04- | - | YT4L-BS | - | - |
| 50 | RB50 | 91 | - | - | - | 6N4-2A |
| 50 | RC50 | -02 | YTX4L-BS | YT4L-BS | - | - |
| 50 | RG50 | 91 | - | - | YB4L-B | - |
| 50 | RV50 | -81 | - | - | - | 6N4B-2A |
| 50 | Sepia 50 | 97- | - | YT4B-BS | - | - |
| 50 | Sport 50 (Model M12) | 68 | - | - | - | 6N4-2A |
| 50 | TR50 Street Magic | -02 | - | YT4B-BS | - | - |
| 50 | TR50S | 98 | - | YT4B-BS | - | - |
| 50 | TS50 | 74 | - | - | - | 6N4-2A |
| 50 | TS50ERK, K | 78-81 | - | - | - | 6N4B-2A |
| 50 | TS50W, XA, XK | 91 | - | - | YB4L-B | - |
| 50 | Tune 50 | 97- | - | YTX4L-BS | - | - |
| 50 | UR50 (Velde) | -02 | - | YT4B-BS | - | - |
| 50 | UX50 W Zillion | 99 | - | YTX4L-BS | - | - |
| 50 | UZ50X | 06 | - | YTX4L-BS | - | - |
| 50 | X5 | - | - | YTX4L-BS | - | - |
| 50 | YR50 | -02 | - | YT4B-BS | - | - |
| 50 | Zillion | - | - | YTX4L-BS | - | - |
| 50 | ZR50K, KE | 79 | - | - | - | 6N4B-2A |
| 50 | ZZ50 | 97 | - | YTX4L-BS | - | - |
| 55 | Model 31 | 68 | - | - | - | 6N2-2A-4 |
| 70 | DRZ70 | 08 | - | YT4B-BS | - | - |
| 75 | TS75 Colt | 75-77 | - | - | - | 6N4-2A |
| 80 | A80 | 92 | - | - | - | 6N4-2A |
| 80 | CP80 | 92 | - | - | YB5L-B | - |
| 80 | DG80 | 91 | - | - | YB4L-B | - |
| 80 | FB80, M | 91-95 | YTX4L-BS | YT4L-BS | - | - |
| 80 | FB80D | 95 | - | YTX5L-BS | - | - |
| 80 | FR80 | 95 | YTX4L-BS | YT4L-BS | - | - |
| 80 | GT80E, EX, L, LX | -81 | - | - | - | 6N4B-2A |
| 80 | RG80, C | 85-95 | - | - | YB4L-B | - |
| 80 | Sport 80 (Models K11 & K11P) | 68 | - | - | - | 6N4-2A |
| 80 | Trail 80 (Models K15 & K15P) | 68 | - | - | - | 6N4-2A |
| 80 | TS80ER | 91 | - | - | - | 6N4B-2A |
| 80 | TS80X | 84-87 | - | - | YB4L-B | - |
| 90 | CS90G | 91 | - | - | YB5L-B | - |
| 90 | FB90 | -02 | YTX4L-BS | YT4L-BS | - | - |
| 90 | Model K10, Model K10P | 68 | - | - | - | 6N4-2A |
| 90 | RV90 Rover | 72 | - | - | - | 6N2-2A-4 |
| 90 | RV90 Rover | 73-77 | - | - | - | 6N4B-2A |
| 90 | RV90 Rover, Vanvan | -92 | - | - | - | 6N4B-2A |
| 90 | TC90 | - | - | - | - | 6N4-2A |
| 90 | TC90J, TC90R | - | - | - | - | 6N2-2A-4 |
| 90 | TS90 | - | - | - | - | 6N4-2A |
| 90 | TS90J, R | - | - | - | - | 6N2-2A-4 |
| 100 | A100 Go-fer | 69-91 | - | - | - | 6N4-2A |
| 100 | AG100 | 91-95 | - | YTX5L-BS | - | - |
| 100 | AH100 Address | 95-96 | - | YTX5L-BS | - | - |
| 100 | AX100 | 91 | - | - | - | 6N4-2A |

| CC | Model | Year | High Performance Maintenance Free | Maintenance Free VRLA | YuMicron | Conventional |
|-------------------------|-------------------------------|-------|-----------------------------------|-----------------------|----------|--------------|
| SUZUKI continued | | | | | | |
| 100 | B100P | 91 | - | - | - | 6N4-2A |
| 100 | FB100 | 91 | - | - | YB5L-B | - |
| 100 | GP100V | 91 | - | - | - | 6N4-2A |
| 100 | GT100 | 92 | - | - | - | 6N4B-2A |
| 100 | Scrambler AC100 | 69 | - | - | - | 6N4-2A |
| 100 | SP100 | 83 | - | - | - | 6N4B-2A |
| 100 | Sport AS100 | 69 | - | - | - | 6N4-2A |
| 100 | TC100 Blazer | 73-77 | - | - | - | 6N4-2A |
| 100 | TS100 Honcho | 73-77 | - | - | - | 6N4-2A |
| 100 | TS100 Honcho | 78-81 | - | - | - | 6N4B-2A |
| 105 | B105P | - | - | - | - | 6N4-2A |
| 110 | Address 110 | 15- | - | YTX5L-BS | - | - |
| 110 | E-Starter | - | YTZ5S | - | - | - |
| 110 | Hokuto | - | - | YTX5L-BS | - | - |
| 110 | Smash (Kick-Starter) | 04 | YTZ3 | - | - | - |
| 110 | UG110 Hokuto | 00 | - | YTX5L-BS | - | - |
| 110 | LETS | 12 | YTZ4V | - | - | - |
| 115 | SHOOTER | 13 | YTZ4V | - | - | - |
| 115 | NEX | 12 | YTZ4V | - | - | - |
| 120 | B120P | - | - | - | - | 6N4-2A |
| 120 | TC120, TC120-II, TC120R | 71 | - | - | - | 6N4B-2A |
| 120 | SATRIA 2 TAK | 02 | - | - | YB3L-B | - |
| 125 | AN125 (Vecstar) | -02 | - | YTX7A-BS | - | - |
| 125 | Address V 125,S,G | 05- | - | YTX7A-BS | - | - |
| 125 | RV125 Tracker | -02 | - | YTX7L-BS | - | - |
| 125 | SP125 | 82-83 | - | - | - | 6N4B-2A |
| 125 | AN125 (Vecstar) | 95-96 | - | YTX7A-BS | - | - |
| 125 | Best, Shogun R (Kick-Starter) | 04 | YTZ3 | - | - | - |
| 125 | Burgman | - | - | YTX9-BS | - | - |
| 125 | DN125 | 91 | - | - | YB7-A | - |
| 125 | DR125, D, S | - | - | YTX4L-BS | - | - |
| 125 | DR125, SE, SES | 94-96 | - | YTX7L-BS | - | - |
| 125 | DR125R, SZ | 91 | - | - | - | 6N4-2A |
| 125 | DR125SE | 94-97 | - | YTX7A-BS | - | - |
| 125 | DZ125 | -02 | - | YTX7L-BS | - | - |
| 125 | EN125 | - | - | - | YB7-A | - |
| 125 | Epicuro | - | - | YTX7A-BS | - | - |
| 125 | E-Starter | - | YTZ5S | - | - | - |
| 125 | GK 125 | - | - | - | - | 12N11-3A-1 |
| 125 | GN125 | - | - | - | YB7-A | - |
| 125 | GN125, E | 82-83 | - | - | YB7-A | - |
| 125 | GN125, E | 91-96 | - | - | YB7-A | - |
| 125 | GN125, E, U | 82-98 | - | - | YB7-A | - |
| 125 | GP125, U | 78 | - | - | - | 6N4-2A |
| 125 | GS125ES | 91-92 | - | - | YB7-A | - |
| 125 | GS125S | -99 | - | - | YB7-A | - |
| 125 | GSR 125 | - | - | YTX7A-BS | - | - |
| 125 | GT125, E, T, ET | 74-79 | - | - | - | 12N5-3B |
| 125 | GZ125 Marauder | 99 | - | YTX7L-BS | - | - |
| 125 | HAYATE | 12- | YTZ4V | - | - | - |
| 125 | HJ125 | - | - | - | - | 12N7A-3A |
| 125 | HJ125J | - | - | - | YB7-A | - |
| 125 | HJ125T-9 | - | - | YTX7A-BS | - | - |

Can't find your vehicle listed?
Visit www.yuasa.com for our latest application data

| CC | Model | Year | High Performance Maintenance Free | Maintenance Free VRLA | YuMicron | Conventional |
|-------------------------|-----------------------------|-------|-----------------------------------|-----------------------|----------|--------------|
| SUZUKI continued | | | | | | |
| 125 | HS125T | - | - | YTX7L-BS | - | - |
| 125 | K125 | 91 | - | - | YB10L-B | - |
| 125 | MUSIC 125 | - | - | YTX7A-BS | - | - |
| 125 | NEX GSR 125 | - | - | YTX7A-BS | - | - |
| 125 | NEW SPIN 125 | 10- | YTZ4V | - | - | - |
| 125 | NEW SKY DRIVE | 10- | YTZ4V | - | - | - |
| 125 | PG125 Gamma | - | - | YTX5L-BS | - | - |
| 125 | QS125 | - | - | - | - | 12N7-3A |
| 125 | QS125T-4K | - | - | YTX7A-BS | - | - |
| 125 | RG125, F | 92-95 | - | YTX7L-BS | - | - |
| 125 | RV125 SE, R | 94 | - | YTX7L-BS | - | - |
| 125 | RV125 SE, R | 94 | - | YTX7L-BS | - | - |
| 125 | RV125 Tracker | 73-77 | - | - | - | 6N4-2A |
| 125 | RV125 Tracker | 79-92 | - | - | - | 6N4-2A |
| 125 | SP125 | 82-83 | - | - | - | 6N4B-2A |
| 125 | SP125 | 86-88 | - | - | - | 6N4-2A |
| 125 | SPIN 125 | 06- | YTZ5S | - | - | - |
| 125 | SR 125 | - | - | - | - | 12N14-3A |
| 125 | SHOGUN 125 | 04- | YTZ5S | - | - | - |
| 125 | SHOGUN AXELO | 12- | YTZ4V | - | - | - |
| 125 | SWING 125 | - | - | YTX7A-BS | - | - |
| 125 | THUNDER 125 | 00- | - | - | YB7-A | - |
| 125 | TC125 Prospector | 73-77 | - | - | - | 6N4B-2A |
| 125 | TF125 | -02 | - | - | - | 6N4B-2A |
| 125 | TR-s | 90- | - | - | - | 6N4-2A |
| 125 | TS125 Duster, ER | 71-92 | - | - | - | 6N4B-2A |
| 125 | TS125R, SZ | 91-92 | - | YTX4L-BS | - | - |
| 125 | TS125X | 92 | - | - | YB4L-B | - |
| 125 | VL125 | -02 | - | YTX7L-BS | - | - |
| 150 | AN150 | -02 | - | YTX7A-BS | - | - |
| 150 | Burgman | - | - | YTX9-BS | - | - |
| 150 | SATRIA FU 150 | 12 | YTZ6V | - | - | - |
| 150 | UC150 Epicuro | 99 | - | YTX7A-BS | - | - |
| 185 | GT185 Adventurer (6V) | 73-77 | - | - | - | 6N2-2A-4 |
| 185 | GT185 Adventurer (12V) | 73-77 | - | - | - | 12N11-3A-1 |
| 185 | GT185, E (Electric-Starter) | 73-78 | - | - | - | 12N11-3A-1 |
| 185 | TC185 Ranger | 74-77 | - | - | - | 12N11-3A-1 |
| 185 | TC185 Suerra | 77-81 | - | - | - | 6N4B-2A |
| 185 | TC185 Suerra | 71-76 | - | - | - | 6N4-2A |
| 185 | TF185 | - | - | - | - | 6N4B-2A |
| 185 | TS185 Sierra | 71-76 | - | - | - | 6N4-2A |
| 185 | TS185 Sierra | 77-81 | - | - | - | 6N4B-2A |
| 185 | TS185ER | -02 | - | YTX4L-BS | - | - |
| 185 | TS185ER | 79 | - | - | - | 6N4B-2A |
| 200 | B200 | 91 | - | - | - | 12N7-4A |
| 200 | DR200S | 15-16 | - | YTX7L-BS | - | - |
| 200 | DR200SE | 96-13 | - | YTX7L-BS | - | - |
| 200 | GT200N, EN | 79 | - | - | YB7-A | - |
| 200 | RV200 | -02 | - | YTX7L-BS | - | - |
| 200 | SP200 | 86-88 | - | - | YB4L-B | - |
| 200 | T200, TC200 | - | - | - | YB5L-B | 12N5-3B |
| 200 | TS200R, RM | 91-92 | YTX4L-BS | YT4L-BS | - | - |
| 200 | UH200A Burgman | 14-16 | - | YTX9-BS | - | - |

| CC | Model | Year | High Performance Maintenance Free | Maintenance Free VRLA | YuMicron | Conventional |
|-------------------------|-----------------------------|-------|-----------------------------------|-----------------------|----------|--------------|
| SUZUKI continued | | | | | | |
| 200 | Van Van 200 | 02- | - | YTX7L-BS | - | - |
| 250 | AN250 Burgman | 02- | - | YT12A-BS | - | - |
| 250 | AN250 Burgman | 99 | - | YTX7A-BS | - | - |
| 250 | AN250 Sky Wave | 98 | - | YTX7A-BS | - | - |
| 250 | Big Boy | -02 | - | - | YB10L-A2 | - |
| 250 | DR250 | -01 | YTZ7S | YTX5L-BS | - | - |
| 250 | DR250S | -87 | - | - | YB4L-B | - |
| 250 | DR250S | 90-92 | - | YTX4L-BS | - | - |
| 250 | DR250S (Europe) | 90-95 | - | YTX7L-BS | - | - |
| 250 | DR250S EP, ER, ES | 93-95 | - | YTX7L-BS | - | - |
| 250 | DR-Z250 | 01-07 | YTZ7S | - | - | - |
| 250 | Gemma | 08- | Not Available | - | - | - |
| 250 | Glass Tracker | -02 | - | - | YB10L-A2 | - |
| 250 | Glass Tracker Big Boy | 04- | - | YTX7L-BS | - | - |
| 250 | GN250, E | 82-98 | - | - | YB10L-A2 | - |
| 250 | GNX250, E | 85-92 | - | - | YB10L-A2 | - |
| 250 | GS250T | 80-81 | - | - | YB10L-A2 | - |
| 250 | GSF250 | 95 | - | YTX7A-BS | - | - |
| 250 | GSX250, ES, EZ | 82-92 | - | - | YB12B-B2 | - |
| 250 | GSX250, ET | 80-81 | - | - | YB10L-A2 | - |
| 250 | GW250 | 13-16 | - | YTX9-BS | - | - |
| 250 | GW250F Inazuma | 15 | - | YTX9-BS | - | - |
| 250 | GSX250F, S | 91-95 | - | YTX7A-BS | - | - |
| 250 | GT250, E Hustler | 73-77 | - | - | YB5L-B | 12N5-3B |
| 250 | GT250ET | 94 | - | - | YB10L-A2 | - |
| 250 | GZ250 | 99-12 | - | YTX7L-BS | - | - |
| 250 | GZ250 Marauder | 99-03 | - | YTX7L-BS | - | - |
| 250 | INAZUMA 250 | 12 | - | YTX9-BS | - | - |
| 250 | Model T20 | 69 | - | - | YB5L-B | 12N5-3B |
| 250 | RG250C, E, FC | -92 | - | - | - | 12N5-3B |
| 250 | RGV250 | 89-93 | YTX4L-BS | YT4L-BS | - | - |
| 250 | Scrambler TC250 | 69 | - | - | YB5L-B | 12N5-3B |
| 250 | NEW SKY WAVE | 10 | YTZ4V | - | - | - |
| 250 | SKY WAVE | 8 | YTZ5S | - | - | - |
| 250 | SP250 | 92 | - | - | YB4L-B | - |
| 250 | SP250 | 82-85 | - | - | - | 6N4B-2A |
| 250 | ST250, E type | - | - | YTX7L-BS | - | - |
| 250 | T250, T250-II, T250J, T250R | 72 | - | - | YB5L-B | 12N5-3B |
| 250 | THUNDER 250 | 0 | - | - | - | 12N10-3B |
| 250 | TS250 | 92 | - | - | - | 6N4B-2A |
| 250 | TS250 Savage | 69-72 | - | - | - | 6N2-2A-4 |
| 250 | TS250 Savage | 73-81 | - | - | - | 6N4B-2A |
| 250 | TS250X | -94 | - | - | YB4L-B | - |
| 250 | TU250G | - | - | YTX7L-BS | - | - |
| 250 | TU250X | 95-99 | - | - | YB10L-A2 | - |
| 250 | TU250X | 09-13 | - | YTX7L-BS | - | - |
| 250 | VL250 | -02 | - | YTX7L-BS | - | - |
| 250 | Volty | -02 | - | - | YB10L-A2 | - |
| 300 | GS300L | 82-85 | - | - | YB12B-B2 | - |
| 305 | Scramble TC305 | 69 | - | - | YB5L-B | 12N5-3B |
| 305 | T305 | 69 | - | - | YB5L-B | 12N5-3B |
| 350 | DR350S | 90-96 | - | YTX4L-BS | - | - |
| 350 | DR350S, SH | 90-93 | YTX4L-BS | YT4L-BS | - | - |

World number one for motorcycle batteries

| CC | Model | Year | High Performance Maintenance Free | Maintenance Free VRLA | YuMicron | Conventional |
|-------------------------|---------------------------------|-------|-----------------------------------|-----------------------|----------|--------------|
| SUZUKI continued | | | | | | |
| 350 | DR350SE | 94-99 | - | YTX7L-BS | - | - |
| 350 | T350 Series | 79 | - | - | YB5L-B | 12N5-3B |
| 370 | SP370 | 78-79 | - | - | - | 6N4B-2A |
| 380 | GT380 Sebring | 72-77 | - | - | YB7-A | 12N7-4A |
| 400 | AN400 Burgman | 99-16 | - | YTX9-BS | - | - |
| 400 | Boulevard 400 | 06-16 | - | YTX12-BS | - | - |
| 400 | DR400S | 92 | - | - | - | 6N4B-2A |
| 400 | DR-Z400, E, S, SM | 00-16 | - | YT7B-BS | - | - |
| 400 | Gladius 400 ABS | 09- | - | YT12A-BS | - | - |
| 400 | GN400, L, T, TD, X | 80-92 | - | - | - | 6N4B-2A-3 |
| 400 | GN400T, X | 80-82 | - | - | - | 6N4B-2A |
| 400 | GS 400 SERIES | 06 | - | YTX7L-BS | - | - |
| 400 | GS400 B/N | 77-79 | - | - | YB10L-A2 | - |
| 400 | GS400, E | 91 | - | YTX9-BS | - | - |
| 400 | GS400X | 91-95 | - | YTX9-BS | - | - |
| 400 | GS400X | 77-78 | - | - | YB7-A | 12N7-4A |
| 400 | GSF400 Bandit | 91-93 | - | YTX9-BS | - | - |
| 400 | GSF400 M | - | - | YTX9-BS | - | - |
| 400 | GSR400 | 06-07 | - | YT12A-BS | - | - |
| 400 | GSR400 ABS | 07- | - | YTX9-BS | - | - |
| 400 | GSX400 | - | - | YTX9-BS | - | - |
| 400 | GSX400 EZ | 82 | - | - | YB12B-B2 | - |
| 400 | GSX400 X | 87 | - | - | YB10L-B2 | - |
| 400 | GSX400E, ES, T, S | 83-92 | - | - | YB12B-B2 | - |
| 400 | GSX400E, FE, FX, L, T, S | 80-81 | - | - | YB10L-A2 | - |
| 400 | GSX400FS Inazuma | -02 | - | YTX7A-BS | - | - |
| 400 | GSX400T, S, ES | 82-93 | - | - | YB10L-A2 | - |
| 400 | GSX-R400R, RF | 91-95 | - | YTX9-BS | - | - |
| 400 | Intruder Classic 400 | 08-16 | - | YTX12-BS | - | - |
| 400 | Skywave 400 | 02- | Not Available | - | - | - |
| 400 | SP400 | 80-92 | - | - | - | 6N4B-2A |
| 400 | SV400S | -02 | - | YTX9-BS | - | - |
| 400 | TS400 Apache (Electric-Starter) | 72-75 | - | - | YB5L-B | 12N5-3B |
| 400 | TS400 Apache | 76-77 | - | - | - | 6N4B-2A |
| 400 | TS400T | 92 | - | - | YB10L-A2 | - |
| 400 | VL400 | - | - | YTX12-BS | - | - |
| 400 | VZ400 | -02 | - | YTX7A-BS | - | - |
| 425 | GS425, E, L | 79 | - | - | YB10L-A2 | - |
| 450 | GS450, E | 83-88 | - | - | YB12B-B2 | - |
| 450 | GS450, E | 80-82 | - | - | YB10L-A2 | - |
| 450 | GS450GA | 82-83 | - | - | YB12B-B2 | - |
| 450 | GS450L | 83-86 | - | - | YB12B-B2 | - |
| 450 | GS450L | 80-82 | - | - | YB10L-A2 | - |
| 450 | GS450S | -88 | - | - | YB12B-B2 | - |
| 450 | GS450T, TU | 81-82 | - | - | YB10L-A2 | - |
| 450 | GS450TX | 83 | - | - | YB12B-B2 | - |
| 450 | GS450TX | 82 | - | - | YB10L-A2 | - |
| 500 | DR500, S | 81-83 | - | - | - | 6N4B-2A-3 |
| 500 | DR500S | 92 | - | - | YB4L-B | - |
| 500 | GS500 | 01-04 | - | - | YB10L-A2 | - |
| 500 | GS500, F | 01-07 | - | - | YB10L-B2 | - |
| 500 | GS500E | 89-04 | - | - | YB10L-A2 | - |
| 500 | GS500E, EU | 89-00 | - | - | YB10L-B2 | - |

| CC | Model | Year | High Performance Maintenance Free | Maintenance Free VRLA | YuMicron | Conventional |
|-------------------------|------------------------------|-------|-----------------------------------|-----------------------|----------|--------------|
| SUZUKI continued | | | | | | |
| 500 | GS500EN | - | - | - | YB10L-A2 | - |
| 500 | GS500F | 04- | - | - | YB10L-A2 | - |
| 500 | GT500 Titan | 76-77 | - | - | YB7-A | 12N7-4A |
| 500 | GT500B | 92 | - | - | YB10L-A2 | - |
| 500 | RG500 Gamma | -94 | YTX5L-BS | YT5L-BS | - | - |
| 500 | SP500 | 92 | - | - | YB4L-B | - |
| 500 | SP500 | 81-83 | - | - | - | 6N4B-2A |
| 500 | T500 Titan | 68-92 | - | - | YB7-A | 12N7-4A |
| 550 | GS550, D, E, EG, L, M, T | 77-82 | - | - | YB10L-A2 | - |
| 550 | GS550E, ES, L | 83-86 | - | - | YB10L-B | - |
| 550 | GSX550 | 94 | - | - | YB10L-B | - |
| 550 | GSX550E, L, ES, EF, EV | -92 | - | - | YB10L-B | - |
| 550 | GT550 Indy | 72-77 | - | - | - | 12N11-3A-1 |
| 550 | GT550A, B, K, L, M | 73-77 | - | - | - | 12N11-3A-1 |
| 550 | GT550J, K, L, M | -92 | - | - | YB10L-A2 | - |
| 600 | DR600R, RU, S, SU | 85-89 | - | - | - | 12N5-3B |
| 600 | GSF600, S, SU, U, U II | 95- | - | YTX9-BS | - | - |
| 600 | GSF600S Bandit | 96-03 | - | YTX9-BS | - | - |
| 600 | GSR600 | -03 | - | YTX9-BS | - | - |
| 600 | GSX600F Katana | 88-97 | - | - | YB10L-B2 | - |
| 600 | GSX600F Katana | 98-06 | - | YTX9-BS | - | - |
| 600 | GSX-R600 | 97-16 | - | YTX9-BS | - | - |
| 600 | GSX-R600W | 92-93 | - | YTX9-BS | - | - |
| 600 | RF600R, RU, S | 93-97 | - | YTX9-BS | - | - |
| 600 | SP600 | 85 | - | - | YB5L-B | 12N5-3B |
| 600 | SP6600 | -85 | - | - | - | 12N5-3B |
| 600 | VS600 GLS | - | - | YTX9-BS | - | - |
| 600 | VS600GLF | 95-97 | - | - | YB16B-A | - |
| 600 | GSX-R600 | 11- | - | YTX9-BS | - | - |
| 650 | AN650 Burgman | 03-16 | YTX14H-BS | YTX14-BS | - | - |
| 650 | DL650 V-Strom ABS, Adventure | 04- | - | YTX12-BS | - | - |
| 650 | DR650R, RU | 90-91 | - | - | YB5L-B | - |
| 650 | DR650R, RU | 92-94 | YTX4L-BS | YT4L-BS | - | - |
| 650 | DR650RE, REU | 94-95 | - | YTX12-BS | - | - |
| 650 | DR650RS, RSU | 90-91 | - | - | YB5L-B | - |
| 650 | DR650RSE, RSEU | 91- | - | YTX14-BS | - | - |
| 650 | DR650S | 90-91 | - | - | YB5L-B | 12N5-3B |
| 650 | DR650S ER, ES | 94-95 | - | YTX12-BS | - | - |
| 650 | DR650S N, P | 92-93 | - | YTX4L-BS | - | - |
| 650 | DR650SE | 96-97 | - | - | YB10L-B2 | - |
| 650 | DR650SE | 98-13 | - | YTX9-BS | - | - |
| 650 | DR650SE (CN) | 96-97 | - | YTX9-BS | - | - |
| 650 | DR650SE, SEU | 91-04 | - | YTX9-BS | - | - |
| 650 | DR650SESES | 95- | - | YTX12-BS | - | - |
| 650 | GR650 Tempter, X | 83 | YTX14AHL-BS | - | YB14L-A2 | - |
| 650 | GS650, E, G, GLX, GTZ | 81-83 | YTX14AHL-BS | - | YB14L-A2 | - |
| 650 | GS650EX | 83-92 | - | - | YB10L-A2 | - |
| 650 | GSF650/U | - | - | YTX9-BS | - | - |
| 650 | GSX650/F | - | - | YTX9-BS | - | - |
| 650 | LS650 Savage, S40 | 86-13 | YTX14AHL-BS | - | YB14L-B2 | - |
| 650 | LS650, F, P Savage | -03 | - | - | YB14L-B2 | - |
| 650 | LS650, F, P Savage | 95-01 | - | - | YB14L-B2 | - |
| 650 | LS650, F, P Savage | 86-94 | - | - | YB14L-B2 | - |

Can't find your vehicle listed?
Visit www.yuasa.com for our latest application data

| CC | Model | Year | High Performance Maintenance Free | Maintenance Free VRLA | YuMicron | Conventional |
|-------------------------|---|-------|-----------------------------------|-----------------------|-----------|--------------|
| SUZUKI continued | | | | | | |
| 650 | Skywave 650LX | 05- | Not Available | - | - | - |
| 650 | SV650 | 99-02 | - | YT12A-BS | - | - |
| 650 | SV650, A, SA | 03-10 | - | YT12A-BS | - | - |
| 650 | SV650, S | 83-13 | - | YTX12-BS | - | - |
| 650 | SFV650 Gladius | 09-10 | - | YT12A-BS | - | - |
| 650 | XF650 Freewind | -02 | - | YTX9-BS | - | - |
| 650 | XN85 Turbo | 83-92 | YTX14AHL-BS | - | YB14L-A2 | - |
| 700 | GS700E, GS700ES | 85 | YTX14AHL-BS | - | YB14L-A2 | - |
| 700 | GV700GL Madura | 85 | YTX14AHL-BS | - | YB14L-B2 | - |
| 700 | VS700GL Intruder | 85-87 | - | - | YB16B-A1 | - |
| 750 | DR750S, SU Big | 88-89 | - | - | YB14L-B2 | - |
| 750 | GS750, D, E, ES, L, S, T, Katana | 77-83 | YTX14AHL-BS | - | YB14L-A2 | - |
| 750 | GS750 ABS | 13- | - | YT12A-BS | - | - |
| 750 | GSX750, E, EF, ES, L | 80-86 | - | - | YB14L-A2 | - |
| 750 | GSX750EG Silver Suzi | 80 | - | - | YB14L-A2 | - |
| 750 | GSX750F Katana | 89-97 | YTX14AHL-BS | - | YB14L-B2 | - |
| 750 | GSX750F Katana | 98-06 | - | YTX9-BS | - | - |
| 750 | GSX750P | - | - | YTX12-BS | - | - |
| 750 | GSX750S Katana | 82 | - | - | YB14L-A2 | - |
| 750 | GSX-R750 | 00-16 | - | YT12A-BS | - | - |
| 750 | GSX-R750 | 96-99 | - | YTX9-BS | - | - |
| 750 | GSX-R750 | 86-92 | YTX14AHL-BS | - | YB14L-A2 | - |
| 750 | GSX-R750, W | 92-93 | - | YTX12-BS | - | - |
| 750 | GSX-R750, W | 94-95 | - | YTX9-BS | - | - |
| 750 | GSX-S750 | 15-16 | - | YT12A-BS | - | - |
| 750 | GT750 Le Mans | 72-77 | YTX14AHL-BS | - | YB14L-A2 | - |
| 750 | VS750GL Intruder, GLP | 86-91 | - | - | YB16B-A1 | - |
| 800 | DR800S, SU Big | 90-97 | - | YTX14-BS | - | - |
| 800 | DR800ST | 92 | - | - | YB14L-B2 | - |
| 800 | VL800 Intruder Volusia, Boulevard C50, T, M50 | 01-08 | - | YTX12-BS | - | - |
| 800 | VS800 GL, S Intruder, Boulevard S50 | 92-12 | - | - | YB16B-A1 | - |
| 800 | VX800 | 90-93 | - | - | YB16B-A | - |
| 800 | VX800, U | 96-97 | - | - | YB16B-A1 | - |
| 800 | VZ800 Marauder | 97-08 | - | YTX12-BS | - | - |
| 850 | GS850G, GL, GT, GZ | 79-83 | YTX14AHL-BS | - | YB14L-A2 | - |
| 850 | X1-E | 92 | - | - | - | 6N4-2A |
| 900 | RF900, R, RR, S, ZS | 94-97 | - | YTX9-BS | - | - |
| 1000 | DL1000 | -02 | - | YTX14-BS | - | - |
| 1000 | DL1000 V-Strom | 02- | YTX14H-BS | YTX14-BS | - | - |
| 1000 | GS1000, E, G, GL, H, L, S | 78-82 | YTX14AHL-BS | - | YB14L-A2 | - |
| 1000 | GSX-R1000 | 01-04 | - | YTX12-BS | - | - |
| 1000 | GSX-R1000 | 05-16 | - | YT12A-BS | - | - |
| 1000 | GSX-R1000 ABS | 14- | - | YT12A-BS | - | - |
| 1000 | SV1000, S | 03-07 | GYZ16H | YTX14-BS | - | - |
| 1000 | TL1000R | 98-03 | - | YT12A-BS | - | - |
| 1000 | TL1000S | 97-01 | - | YTX12-BS | - | - |
| 1100 | GS1100, E, EF, ES, EX | 80-86 | - | - | SYB14L-A2 | - |
| 1100 | GS1100G | 91-95 | - | YTX14-BS | - | - |
| 1100 | GS1100G, K, L, Katana | 82-86 | YTX14AHL-BS | - | YB14L-A2 | - |
| 1100 | GSX1100F Katana | 88-94 | YTX14AHL-BS | - | YB14L-B2 | - |
| 1100 | GSX1100G | 91-93 | GYZ16H | YTX14-BS | - | - |
| 1100 | GSX1100L | 80 | - | - | SYB14L-A2 | - |
| 1100 | GSX1100S Katana | 82 | - | - | SYB14L-A2 | - |

| CC | Model | Year | High Performance Maintenance Free | Maintenance Free VRLA | YuMicron | Conventional |
|-------------------------|-----------------------------|-------|-----------------------------------|-----------------------|--------------|---------------|
| SUZUKI continued | | | | | | |
| 1100 | GSX1100SZ | 82 | - | - | YB14L-A2 | - |
| 1100 | GSX-R1100 | 86-92 | YTX14AHL-BS | - | YB14L-A2 | - |
| 1100 | GSX-R1100 | 93-98 | - | YTX12-BS | - | - |
| 1100 | GSX-R1100W | 93-99 | - | YTX12-BS | - | - |
| 1100 | TL1000R, S | 98-03 | - | YT12A-BS | - | - |
| 1100 | TL1000S V | 97-01 | - | YTX12-BS | - | - |
| 1150 | GS1150E, ES, S | 83-86 | - | - | YB14L-B2 | - |
| 1200 | Bandit 1200S | - | - | YTX12-BS | - | - |
| 1200 | GS1200SS | -02 | - | YTX12-BS | - | - |
| 1200 | GSF1200, S, SA Bandit | 97-06 | YTX12-BS | YT12A-BS | - | - |
| 1200 | GSX1200 | 99-00 | - | YTX12-BS | - | - |
| 1200 | GV1200GL Marauder | 85-86 | YTX14AHL-BS | - | YB14L-B2 | - |
| 1250 | GSF1250/S | - | - | YT12A-BS | - | - |
| 1250 | GSF1250S, A Bandit | 07-08 | - | YT12A-BS | - | - |
| 1250 | GFS1250-FA | 11- | - | YT12A-BS | - | - |
| 1250 | GSX1250S, A Bandit, FA | 07- | - | YT12A-BS | - | - |
| 1300 | Bandit 1250S ABS | 14- | - | YT12A-BS | - | - |
| 1300 | GSX1300BK B-King | 08 | - | YTX12-BS | - | - |
| 1300 | GSX1300R Hayabusa | 99-07 | - | YT12A-BS | - | - |
| 1300 | GSX1300R, Z Hayabusa | 08- | - | YTX12-BS | - | - |
| 1400 | GSX1400 | -02 | - | YTX14-BS | - | - |
| 1400 | GV1400GC, D, T Cavalcade | 86-88 | - | - | SY50-N18L-AT | - |
| 1400 | VS1400GL Intruder, GLP, S83 | 87-08 | - | YTX16-BS-1 | - | - |
| 1400 | VS1400GLF, GLP | 88-03 | - | YTX16-BS-1 | - | - |
| 1500 | VL1500 Intruder, C90, T | 98-08 | - | YTX16-BS-1 | - | - |
| 1500 | VL 1500 Boulevard C90 | 14-16 | YTX20CH-BS | - | - | - |
| 1500 | VZ1500 Boulevard M90 | 09-16 | YTX20CH-BS | - | - | - |
| 1600 | Marauder, Boulevard M95 | 04-05 | YTX20CH-BS | YTX16-BS | - | - |
| 1800 | VLR1800 | - | YTX20CH-BS | - | - | - |
| 1800 | VLR1800 (C109R) | 08-12 | YTX20CH-BS | - | - | - |
| 1800 | VZR1800 (M109R) | 06-16 | YTX20CH-BS | - | - | - |
| TGB/WINKING | | | | | | |
| 50 | 50 Akros | 97 | YTX4L-BS | YT4L-BS | - | - |
| 50 | 50 Ergon | 97 | YTX4L-BS | YT4L-BS | - | - |
| 50 | AS25 Bunny | 96 | - | - | YB4L-B | - |
| 50 | AS50 X Bunny | 94-95 | - | - | YB4L-B | - |
| 50 | AS50 X Kurier | 95 | - | - | YB4L-B | - |
| 50 | AT50 Bunny | 93 | - | - | YB4L-B | - |
| 50 | AT50 Bunny Gespann | 93-94 | - | - | YB4L-B | - |
| TRIUMPH | | | | | | |
| 120 | Bonneville | - | - | - | - | 12N7-3B |
| 150 | T150 | - | - | - | - | 12N7-4A |
| 150 | Trident | - | - | - | - | 12N7-3B |
| 173 | Tigress | - | - | - | - | 6N11A-1B |
| 200 | Tiger | - | - | - | - | 6N11A-1B |
| 250 | T250 | - | - | - | - | 12N7-4A |
| 250 | Tigress (12V) | - | - | - | - | 6N11A-1B (x2) |
| 250 | Tigress (6V) | - | - | - | - | 6N11A-1B |
| 350 | 350 (12V) | - | - | - | - | B39-6 (x2) |
| 350 | 350 (6V) | - | - | - | - | 6N11A-1B |

World number one for motorcycle batteries

| CC | Model | Year | High Performance Maintenance Free | Maintenance Free VRLA | YuMicron | Conventional |
|--------------------------|-----------------------------|-------|-----------------------------------|-----------------------|----------|--------------|
| TRIUMPH continued | | | | | | |
| 350 | 350 3TA, Twenty One | - | - | - | - | B38-6A |
| 500 | 500 (12V) | - | - | - | - | B39-6 (x2) |
| 500 | 5TA, TR5A/R | - | - | - | - | 6N11A-1B |
| 600 | 600 (12V) | - | - | - | - | B39-6 (x2) |
| 600 | 6T, T20B | - | - | - | - | 6N11A-1B |
| 600 | Daytona 600/650, Speed Four | 03-05 | - | YTX9-BS | - | - |
| 600 | TT600 | 00-03 | - | YTX12-BS | - | - |
| 650 | 600 | - | - | - | - | B39-6 (x2) |
| 650 | 600 (12V) | - | - | - | - | B39-6 (x2) |
| 650 | 6T, T20B | - | - | - | - | 6N11A-1B |
| 650 | T120 Bonneville | - | - | - | YB7L-B | - |
| 675 | Daytona 675 | 06-10 | - | YT7B-BS | - | - |
| 675 | Daytona 675 | 11-16 | - | YTX9-BS | - | - |
| 675 | Street Triple | 07- | - | YTX9-BS | - | - |
| 675 | Street Triple R | 08- | - | YTX9-BS | - | - |
| 750 | Bonneville, Tiger | - | - | - | YB9-B | 12N9-4B-1 |
| 750 | Daytona/Trident | 93-00 | - | - | YB14L-A2 | - |
| 750 | Speed Triple | 97 | - | - | YB14L-A2 | - |
| 750 | T150 Trident | - | - | - | YB7L-B | - |
| 750 | T750 | - | - | - | - | 12N7-4A |
| 750 | All Other Models | 93-97 | YTX14AHL-BS | - | - | - |
| 800 | Bonneville | 01-05 | - | YTX12-BS | - | - |
| 800 | Speedmaster | 03-05 | - | YTX12-BS | - | - |
| 800 | Tiger | 11-16 | - | YTX16-BS | - | - |
| 800 | Tiger XR | 15 | - | YTX20L-BS | - | - |
| 865 | America | 09- | - | YTX12-BS | - | - |
| 865 | Bonneville T100, SE | 05-07 | - | YTX12-BS | - | - |
| 865 | Bonneville T100, SE,FI | 08-10 | - | YT12B-BS | - | - |
| 865 | Bonneville T100, SE, FI | 11- | - | YTX12-BS | - | - |
| 865 | Scrambler | 05-07 | - | YTX12-BS | - | - |
| 865 | Scrambler | 08-10 | - | YT12B-BS | - | - |
| 865 | Scrambler | 11- | - | YTX12-BS | - | - |
| 865 | Speedmaster | 03-15 | - | YTX12-BS | - | - |
| 865 | Thrupton | 09- | - | YTX12-BS | - | - |
| 885 | Legend TT | 99-02 | - | - | YB14L-A2 | - |
| 885 | T509 Speed Triple | - | - | - | YB14L-A2 | - |
| 885 | Thunderbird Sport | - | - | YTX14-BS | - | - |
| 885 | Tiger | -98 | - | - | YB14L-A2 | - |
| 885 | Tiger | 99-01 | - | YTX14-BS | - | - |
| 885 | Trophy | - | - | - | YB14L-A2 | - |
| 900 | Adventurer | 96-02 | - | - | YB14L-A2 | - |
| 900 | Bonneville 100 | 15-16 | - | YTX12-BS | - | - |
| 900 | Daytona | 93-99 | - | - | YB14L-A2 | - |
| 900 | Legend TT | 98- | - | - | YB14L-A2 | - |
| 900 | Scrambler, Bonneville | 06-07 | - | YTX12-BS | - | - |
| 900 | Speed Triple | 94-00 | - | - | YB14L-A2 | - |
| 900 | Sport Sprint | 98 | - | - | YB14L-A2 | - |
| 900 | Sprint | 92-99 | - | - | YB14L-A2 | - |
| 900 | Street Twin | 15-16 | - | YTX12-BS | - | - |
| 900 | Super III | 94-99 | - | - | YB14L-A2 | - |
| 900 | T509 Speed Triple | 97-01 | - | - | YB14L-A2 | - |
| 900 | T90 | - | - | - | - | 6N11A-1B |
| 900 | Thrupton | 03-07 | - | YTX12-BS | - | - |



| CC | Model | Year | High Performance Maintenance Free | Maintenance Free VRLA | YuMicron | Conventional |
|--------------------------|---|-------|-----------------------------------|-----------------------|-----------|--------------|
| TRIUMPH continued | | | | | | |
| 900 | Thunderbird | 02-03 | YTX14AHL-BS | - | - | - |
| 900 | Thunderbird | 95-02 | - | - | YB14L-A2 | - |
| 900 | Tiger | 93-98 | - | - | YB14L-A2 | - |
| 900 | Tiger | 99-01 | - | YTX14-BS | - | - |
| 900 | Trident | 91-00 | - | - | YB14L-A2 | - |
| 900 | Trident Sprint | 93-96 | - | - | YB14L-A2 | - |
| 900 | Trophy | 91-98 | - | - | YB14L-A2 | - |
| 900 | All Other Models | 91-01 | YTX14AHL-BS | - | - | - |
| 955 | Daytona 955i, Speed Triple, Sprint ST, RS | 99-04 | - | YTX14-BS | - | - |
| 955 | Sprint RS | 00-04 | - | YTX14-BS | - | - |
| 955 | T595 Daytona | 97-98 | - | - | YB14L-A2 | - |
| 955 | Tiger | 02-06 | - | YTX14-BS | - | - |
| 955 | All Other Models | 96-97 | YTX14AHL-BS | - | - | - |
| 956 | Masterblaster | 96-97 | - | - | YB14L-A2 | - |
| 1000 | Daytona | 91-93 | YTX14AHL-BS | - | YB14L-A2 | - |
| 1050 | Speed Triple | 05-10 | - | YTX12-BS | - | - |
| 1050 | Speed Triple | 11-16 | - | YTX14-BS | - | - |
| 1050 | Sprint GT | 11-16 | - | YTX14-BS | - | - |
| 1050 | Tiger | 07-11 | - | YT12B-BS | - | - |
| 1050 | Tiger | 12-16 | - | YTX14-BS | - | - |
| 1050 | Tiger Sport | 12-14 | - | YTX14-BS | - | - |
| 1200 | Bonneville 120 | 15-16 | - | YTX12-BS | - | - |
| 1200 | Daytona | 93-99 | - | - | YB14L-A2 | - |
| 1200 | Thrupton | 15-16 | - | YTX12-BS | - | - |
| 1200 | Trophy | 00-04 | - | YTX14-BS | - | - |
| 1200 | Trophy | 91-98 | - | - | YB14L-A2 | - |
| 1200 | Trophy | 13- | - | YTX20L-BS | - | - |
| 1215 | Trophy | 12-16 | - | YTX20L-BS | - | - |
| 1215 | Trophy SE | 12-14 | - | YTX20L-BS | - | - |
| 1215 | Tiger Explorer | 12-16 | - | YTX20L-BS | - | - |
| 1215 | VG2 | 14- | - | YTX20L-BS | - | - |
| 1215 | VN2 Tiger Explorer | 14- | - | YTX20L-BS | - | - |
| 1597 | Thunderbird BF | 14-16 | - | YTX20L-BS | - | - |
| 1597 | Thunderbird BFL | 14-16 | - | YTX20L-BS | - | - |
| 1597 | Thunderbird BKX | 14-16 | - | YTX20L-BS | - | - |
| 1700 | Thunderbird | 09- | - | YTX20L-BS | - | - |
| 2294 | XJX Rocket III | 14-16 | - | YTX20L-BS | - | - |
| 2300 | Rocket III | 03-16 | - | YTX20L-BS | - | - |
| | All Other Models | 93-99 | YTX14AHL-BS | - | - | - |
| VALPADANA | | | | | | |
| 850 | Motori agricoli | 89 | - | - | Y60-N24-A | - |
| VELOCETTE | | | | | | |
| 200 | LE | - | - | - | - | B38-6A (x2) |
| 1200 | 350, 500, Early Venson | - | - | - | - | B38-6A |
| 1200 | Early Thrupton, Viper | - | - | - | - | B38-6A |
| 1200 | Vogue | - | - | - | - | B38-6A (x2) |
| WuYang-HONDA | | | | | | |
| 100 | WH100T | - | - | YTX5L-BS | - | - |
| 125 | WH125T | - | - | YTX9-BS | - | - |

Can't find your vehicle listed?
 Visit www.yuasa.com for our latest application data

| CC | Model | Year | High Performance Maintenance Free | Maintenance Free VRLA | YuMicron | Conventional |
|-------------------------------|----------------------------|-------|-----------------------------------|-----------------------|----------|--------------|
| WuYang-HONDA continued | | | | | | |
| 125 | WH125T-2 | - | - | YTX7L-BS | - | - |
| 125 | LEAD | - | - | YTX7L-BS | - | - |
| 125 | WY125-3,C,F | - | - | - | - | 12N7A-3A |
| XinDaZhou HONDA | | | | | | |
| 50 | REN50 | - | - | YTX4L-BS | - | - |
| 50 | SDH50QT 16 | - | - | - | YB4L-B | - |
| 50 | Today | - | - | YTX4L-BS | - | - |
| 125 | SDH125 | - | - | - | - | 12N9-4B-1 |
| 125 | SDH125T-21,80 | - | - | YTX7A-BS | - | - |
| YAMAHA | | | | | | |
| 50 | Aero X R, Max | - | - | - | YB4L-B | - |
| 50 | Axis | - | - | YTX4L-BS | - | - |
| 50 | BA50, S, N, C | 06- | YTX4L-BS | YT4L-BS | - | - |
| 50 | Beluga | - | - | - | YB4L-B | - |
| 50 | Breeze | - | - | - | YB4L-B | - |
| 50 | BWs Bump, Spy | 99 | - | - | YB4L-B | - |
| 50 | BWs Original | 00 | - | - | YB4L-B | - |
| 50 | BWs | - | - | YTX5L-BS | - | - |
| 50 | BX50S, N, S Gear | - | - | YTX5L-BS | - | - |
| 50 | CA50, E Riva | 83-84 | - | - | - | 6YB8L-B |
| 50 | CE50 Riva Jog | 86-87 | - | - | YB4L-B | - |
| 50 | CE50, D, P, ZR Jog | - | - | YTX5L-BS | - | - |
| 50 | CE50S Riva | 86-87 | - | - | YB4L-B | - |
| 50 | CG50, Riva | 88-91 | - | - | YB4L-B | - |
| 50 | CR50, Z | 89-93 | - | - | YB4L-B | - |
| 50 | CS50, Z | 05 | - | YTX4L-BS | - | - |
| 50 | CS50, M, Z | 09- | - | YT4L-BS | - | - |
| 50 | CV50 Riva | 84 | - | - | - | 6YB8L-B |
| 50 | CV50, ZR | 84 | - | YTX4L-BS | - | - |
| 50 | CV50A, R, ZR | 04 | - | YTX4L-BS | - | - |
| 50 | CW50 Zuma | 89-90 | - | - | YB4L-B | - |
| 50 | CW50 Zuma II | 97-01 | - | - | YB4L-B | - |
| 50 | CW50, RS, RSX BWs | 91-97 | - | - | YB4L-B | - |
| 50 | CW50L, LN, N, RS, RSP | 04-09 | - | - | YB4L-B | - |
| 50 | CW50, N, RS, RSP | 09- | - | - | YB4L-B | - |
| 50 | CW50RSP NG | 96-97 | - | - | YB4L-B | - |
| 50 | CY50 Riva Jog | 92-01 | - | YTX4L-BS | - | - |
| 50 | CY50, B, D, E, G, R, Z | 89-95 | - | YTX4L-BS | - | - |
| 50 | CY50R | 09- | - | YT4L-BS | - | - |
| 50 | DT50 Enduro | 88-90 | - | - | - | 6N4B-2A-3 |
| 50 | DT50, M | 80-81 | - | - | - | 6N4A-4D |
| 50 | DT50MX | 82-87 | - | - | - | 6N4B-2A-3 |
| 50 | DT50R | 89-97 | - | - | YB3L-A | - |
| 50 | EW50 | 05 | - | - | YB4L-B | - |
| 50 | EW50N | 05- | - | - | YB4L-B | - |
| 50 | FS1-DX | 75-79 | - | - | - | 6N4A-4D |
| 50 | Gear BX50,N, Parking Stand | 07- | - | YTX5L-BS | - | - |
| 50 | Jog 50Z | - | - | YT4B-BS | - | - |
| 50 | JOG, ZR | -13 | YTZ7S | YTX5L-BS | - | - |
| 50 | LB-2M Chappy | 79 | - | - | - | 6N4-2A-4 |
| 50 | LB50P Chappy | 78-82 | - | - | - | 6N4-2A-5 |

| CC | Model | Year | High Performance Maintenance Free | Maintenance Free VRLA | YuMicron | Conventional |
|-------------------------|--------------------|-------|-----------------------------------|-----------------------|----------|--------------|
| YAMAHA continued | | | | | | |
| 50 | LC50 Champ | 80-81 | - | - | - | 6N4-2A-5 |
| 50 | LC50P Champ | 80-81 | - | - | - | 6N4-2A-5 |
| 50 | MJ50 Towny | 82 | - | - | - | 6N4-2A-5 |
| 50 | NEOOS | 98 | - | - | YB4L-B | - |
| 50 | NG | - | - | - | YB4L-B | - |
| 50 | Original | - | - | - | YB4L-B | - |
| 50 | QT50 Yamahopper | 79-87 | - | - | - | 6N4-2A-5 |
| 50 | RD50, DX, M | 78-81 | - | - | - | 6N4A-4D |
| 50 | RD50M | 82 | - | - | - | 6N4B-2A-3 |
| 50 | RX50, Special | 83-84 | - | - | - | 6N4-2A-5 |
| 50 | RZ50 | - | - | YT4B-BS | - | - |
| 50 | SG50 Sting | 84 | - | - | YB2.5L-C | - |
| 50 | SH50 Riva Razz | 87-01 | - | - | YB4L-B | - |
| 50 | SH50, E, D, M Riva | 87-94 | - | - | YB4L-B | - |
| 50 | Slider | 00 | - | - | YB4L-B | - |
| 50 | Spy | - | - | - | YB4L-B | - |
| 50 | STS/SS | - | - | - | YB4L-B | - |
| 50 | TTR50E, EY, EV | 06-16 | - | YT4B-BS | - | - |
| 50 | TY50M | 80 | - | - | - | 6N4A-4D |
| 50 | TZR50 | 09- | - | YT4L-BS | - | - |
| 50 | V50D, N | 93 | - | YT4B-BS | - | - |
| 50 | Vino Deluxe | - | - | YTX5L-BS | - | - |
| 50 | Vino Molfe | - | - | YTX5L-BS | - | - |
| 50 | Vox Deluxe | - | - | YTX5L-BS | - | - |
| 50 | Why | 99 | - | - | YB4L-B | - |
| 50 | XC50 Vino Classic | 06-12 | YTZ7S | YTX5L-BS | - | - |
| 50 | XC50, D, H Vino | 04 | - | YTX5L-BS | - | - |
| 50 | XF50, D Vox | 07-09 | - | YTX5L-BS | - | - |
| 50 | XF50W (C3) | 07-12 | YTZ7S | YTX5L-BS | - | - |
| 50 | YA50R Axis | 96- | YTX4L-BS | YT4L-BS | - | - |
| 50 | YA50T | 93 | YTX4L-BS | YT4L-BS | - | - |
| 50 | YB-1 | - | - | YT4B-BS | - | - |
| 50 | YB50 | 98 | - | - | - | 6N4-2A-2 |
| 50 | YB50 | - | - | YT4B-BS | - | - |
| 50 | YE50 Zest | 93-97 | - | - | YB4L-B | - |
| 50 | YH50 | 09- | - | - | YB4L-B | - |
| 50 | YL50 | - | - | YTX4L-BS | - | - |
| 50 | YM50 Breeze | 95-96 | - | - | YB4L-B | - |
| 50 | YN50, M | 09- | - | - | YB4L-B | - |
| 50 | YN50F | 09- | - | - | YB5L-B | - |
| 50 | YQ50, L | 05- | - | - | YB4L-B | - |
| 50 | YSR50 | 87-92 | - | - | - | 6N4-2A-5 |
| 50 | YV50H | 06 | - | YT4B-BS | - | - |
| 50 | YW50A Zuma | 02-12 | YTZ7S | YTX5L-BS | - | - |
| 50 | YW50F BWOS | - | YTZ7S | YTX5L-BS | - | - |
| 50 | YZ50, D, ZS | - | - | YT4B-BS | - | - |
| 60 | JT2 Mini Enduro | 72 | - | - | - | 6N2-2A-3 |
| 60 | RD60 | 73-75 | - | - | - | 6N4A-4D |
| 65 | CW65 | 94 | - | - | YB4L-B | - |
| 75 | V-75 | 88- | - | - | - | 6N4-2A-2 |
| 80 | CV80 Riva | 83-87 | - | - | 6YB11-2D | 6N11-2D |
| 80 | DT80 Mini Enduro | 81-83 | - | - | - | 6N4-2A-5 |
| 80 | DT80LC, LC II | 83-96 | - | - | YB3L-B | - |
| 80 | DT80MX, MXS | 81-83 | - | - | - | 6N4-2A-5 |

World number one for motorcycle batteries

| CC | Model | Year | High Performance Maintenance Free | Maintenance Free VRLA | YuMicron | Conventional |
|-------------------------|-------------------------------|-------|-----------------------------------|-----------------------|----------|--------------|
| YAMAHA continued | | | | | | |
| 80 | FS 1DX80 | 80 | - | - | - | 6N4A-4D |
| 80 | FS80SE | 81 | - | - | - | 6N4A-4D |
| 80 | G6S, G6SB | 70-71 | - | - | - | 6N4A-4D |
| 80 | G7S | 72 | - | - | - | 6N4A-4D |
| 80 | GT1 Mini Enduro | 73 | - | - | - | 6N4-2A-5 |
| 80 | GT80 Mini Enduro | 74-80 | - | - | - | 6N4-2A-5 |
| 80 | LB80 Chappy | 76-78 | - | - | - | 6N4-2A-5 |
| 80 | LB80-2A | 95 | - | - | - | 6N4-2A-5 |
| 80 | RD80LC | 82 | - | - | - | 6N4A-4D |
| 80 | RD80LC II | 83-86 | - | - | YB3L-B | - |
| 80 | RD80MX | 81-82 | - | - | - | 6N4B-2A-3 |
| 80 | RX80SE | 82 | - | - | - | 6N4-2A-4 |
| 80 | SV80 | 88-90 | - | - | - | 12N7-3B |
| 80 | TZR80, D | 91- | YTX4L-BS | YT4L-BS | - | - |
| 80 | V-80 E/DX | 90 | - | - | - | 6N11-2D |
| 80 | YE80 Zesyrt | 94-96 | - | - | YB4L-B | - |
| 80 | YG1 | 62-66 | - | - | - | 6N4A-4D |
| 80 | YG5T, YG5S | 68-69 | - | - | YB7L-B | 12N7-3B |
| 80 | YSR80, B, D | 92 | - | - | - | 6N4-2A-5 |
| 90 | CR90 | 91 | - | - | YB4L-B | - |
| 90 | HS1, HS1B | 70-71 | - | - | - | 12N5.5-3B |
| 90 | HT1, HT1B 90 Enduro | 70-71 | - | - | - | 6N2-2A-3 |
| 90 | T90D, N | - | - | YTX4L-BS | - | - |
| 90 | TTR90E, EV (Electric Starter) | 03-07 | - | YT4B-BS | - | - |
| 90 | YA90 | 93- | YTX4L-BS | YT4L-BS | - | - |
| 100 | Aero X100 | 00 | - | YTX4L-BS | - | - |
| 100 | AG100E, F | 93- | - | - | - | 6N4-2A-4 |
| 100 | BWs100 | 99 | - | YTX5L-BS | - | - |
| 100 | CUXI 100 | - | - | YTX5L-BS | - | - |
| 100 | DT100 Enduro | 74-76 | - | - | - | 6N4B-2A-3 |
| 100 | DT100 Enduro | 77-83 | - | - | - | 6N4-2A-5 |
| 100 | DX-100 | 99- | - | - | - | 6N4-2A-2 |
| 100 | L5T, L5TA | 69-70 | - | - | YB7L-B | 12N7-3B |
| 100 | LS2 | 72 | - | - | - | 12N5.5A-3B |
| 100 | LT2, LT3 100 Enduro | 72-73 | - | - | - | 6N4A-4D |
| 100 | NeoOs 100 | 00 | - | YTX4L-BS | - | - |
| 100 | RS100 | 75-76 | - | - | - | 6N4A-4D |
| 100 | RS100, DX | 79-81 | - | - | - | 6N4-2A-4 |
| 100 | RS100T | 95 | - | - | - | 6N4A-4D |
| 100 | RX-S | 99 | - | - | - | 6N4-2A-2 |
| 100 | RXZ100S | 95 | - | - | - | 6N4A-4D |
| 100 | TQ100 | 01 | YTX4L-BS | YT4L-BS | - | - |
| 100 | V100 | 93-94 | - | - | YB3L-B | - |
| 100 | V100E | 93-94 | - | - | YB5L-B | - |
| 100 | XC100 | 07 | - | YT7B-BS | - | - |
| 100 | YB100 | 07 | - | - | YB2.5L-C | - |
| 100 | YFA-1 Breeze | 89-95 | - | - | YB12C-A | - |
| 100 | YL2C/CM | 68 | - | - | YB7L-B | 12N7-3B |
| 100 | YN100 | 09- | - | YT4L-BS | - | - |
| 100 | YT100 (Taiwan) | 99 | - | YTX5L-BS | - | - |
| 100 | YW100EL | 09- | - | YT4L-BS | - | - |
| 105 | T105E, SE | - | - | - | - | 12N5-3B |
| 110 | T110S, SE, SEC, LSE | - | - | - | YB5L-B | 12N5-3B |
| 110 | TTR110EX, EY, EX | - | - | YT4B-BS | - | - |

| CC | Model | Year | High Performance Maintenance Free | Maintenance Free VRLA | YuMicron | Conventional |
|-------------------------|-----------------------------|-------|-----------------------------------|-----------------------|----------|--------------|
| YAMAHA continued | | | | | | |
| 110 | V110, E | 93-95 | - | - | YB5L-B | - |
| 110 | YBR110A | - | - | - | YB5L-B | - |
| 115 | AF115 | - | YTZ5S | - | - | - |
| 115 | AL115, C, F | - | - | - | YB5L-B | - |
| 115 | AL115, S, C | 07- | YTZ5S | - | - | - |
| 115 | AT115, C | - | - | - | YB7B-B | - |
| 115 | CUXI 115 | - | - | YTX5L-BS | - | - |
| 115 | CUXI IS | - | YTZ6V | - | - | - |
| 115 | RT115 | 93 | - | - | - | 6N4-2A-4 |
| 115 | RTX115 | 93 | - | - | - | 6N4-2A-4 |
| 115 | T115LE, LSE | 09- | - | - | YB5L-B | - |
| 115 | X-RIDE | 13 | YTZ4V | - | - | - |
| 125 | 125 Enduro | 69-71 | - | - | - | 12N7-3B |
| 125 | AEROX 125 LC | 16 | YTZ5S | - | - | - |
| 125 | AS2C | 69 | - | - | - | 12N5.5-3B |
| 125 | AT1E, AT1B, AT1C 125 Enduro | 69-71 | - | - | YB7L-B | 12N7-3B |
| 125 | AT2, AT3 125 Enduro | 72-73 | - | - | YB7L-B | 12N7-3B |
| 125 | Axis Treet | - | - | YTX7A-BS | - | - |
| 125 | BL125 Beluga | 85 | - | - | YB7C-A | - |
| 125 | BWs125 | - | - | YT7B-BS | - | - |
| 125 | Cygnus X SR | - | - | YT7B-BS | - | - |
| 125 | DT125 | 74 | - | - | - | 6N6-3B-1 |
| 125 | DT125 Enduro | 74-81 | - | - | YB7L-B | 12N7-3B |
| 125 | DT125LC | 84-87 | - | - | YB3L-B | - |
| 125 | DT125R E | 88-96 | - | - | YB3L-B | - |
| 125 | FINO SPORTY | 12 | YTZ4V | - | - | - |
| 125 | FORCE | 12 | YTZ4V | - | - | - |
| 125 | LEXAM 125 | 06 | YTZ5S | - | - | - |
| 125 | MAJESTY | - | YTZ10S | YTX7A-BS | - | - |
| 125 | Maxster 125 | 00- | - | - | YB7L-B | - |
| 125 | MW125 Tricity | 14- | YTZ7V | - | - | - |
| 125 | MIO SOUL GT 125 | 13 | YTZ5S | - | - | - |
| 125 | MIO GT | 12 | YTZ4V | - | - | - |
| 125 | MIO J | 12 | YTZ4V | - | - | - |
| 125 | MIO SOUL | 8 | YTZ5S | - | - | - |
| 125 | NEW FINO 125 | 15 | YTZ4V | - | - | - |
| 125 | NEW MIO SOUL | 8 | YTZ4V | - | - | - |
| 125 | NMAX | 14- | YTZ7V | - | - | - |
| 125 | NVX125 | - | YTZ7V | - | - | - |
| 125 | NXC125 | 04- | - | YTX7A-BS | - | - |
| 125 | RD125 | 75-76 | - | - | - | 12N5.5A-3B |
| 125 | RD125LC | 82 | - | - | YB5L-B | - |
| 125 | RS125 | - | - | - | YB10L-B | 12N10-3B |
| 125 | RX125 | 95 | - | - | - | 6N4B-2A |
| 125 | SR125, T | 93-95 | - | - | - | 12N7-3B |
| 125 | SV125 | 90 | - | - | - | 12N14-3A |
| 125 | TDR125, R | 93- | - | YTX5L-BS | - | - |
| 125 | TeoOs | - | - | - | YB7L-B | - |
| 125 | TTR125E, LWE | 09- | - | YT4L-BS | - | - |
| 125 | TTR125E, -S, LE, LES, LWE | 03-16 | - | YTX4L-BS | - | - |
| 125 | TW125 | 004 | YTZ7S | - | - | - |
| 125 | TW125 | 99-01 | - | - | YB7C-A | - |
| 125 | TZR125, R | - | - | - | YB5L-B | - |
| 125 | WR125R, X | 09- | - | - | - | 12N5.5-4A |

Can't find your vehicle listed?
Visit www.yuasa.com for our latest application data

| CC | Model | Year | High Performance Maintenance Free | Maintenance Free VRLA | YuMicron | Conventional |
|-------------------------|----------------------------|-------|-----------------------------------|-----------------------|-----------|--------------|
| YAMAHA continued | | | | | | |
| 125 | VP125, R | 09- | - | YTX9-BS | - | - |
| 125 | XC125, CR | 07-09 | - | YT7B-BS | - | - |
| 125 | XC125 Beluga | 86-92 | - | - | YB7C-A | - |
| 125 | XC125 Cygus-X | 04- | - | YTX7A-BS | - | - |
| 125 | XC125 Riva | 87-01 | - | - | YB7C-A | - |
| 125 | XC125 TR Cygnus R | 00 | - | - | YB7C-A | - |
| 125 | XC125E | - | - | YTX7A-BS | - | - |
| 125 | XC125R, T, TR Cygnus | 93- | - | YTX7A-BS | - | - |
| 125 | XC125SR Cygnus X | - | - | YT7B-BS(WC) | - | - |
| 125 | XC125TRB | 07 | - | YTX7A-BS | - | - |
| 125 | XT125 | 82-83 | - | - | - | 6N4A-4D |
| 125 | XTZ125E, K, XE, XK | - | - | - | YB5L-B | - |
| 125 | XV125 | 97- | - | - | YB10L-A2 | - |
| 125 | XV125, S Virago | 99 | - | - | YB5L-B | - |
| 125 | XVS125 | 00 | - | - | YB7L-B | - |
| 125 | XVS125 | 01-04 | YTZ7S | - | - | - |
| 125 | YA6 | 64-66 | - | - | YB10L-B | - |
| 125 | YAS1/C | 68 | - | - | - | 12N5.5A-3B |
| 125 | YBR125DX | 09- | - | - | YB5L-B | - |
| 125 | YB125E, C, CE | - | - | - | YB5L-B | - |
| 125 | YBR125ED | 07-09 | - | YTX7L-BS | - | - |
| 125 | YBR125EG, EGD | 05 | - | - | YB5L-B | - |
| 125 | YJ125T Vino 125 | 04-07 | - | YTX7A-BS | - | - |
| 125 | YP125R Majesty | 99- | - | YTX9-BS | YB7L-B2 | - |
| 125 | YP125, E | 09 | - | YTX9-BS | YB7L-B2 | - |
| 125 | YZFR125 | 09-13 | - | - | - | 12N5.5-3B |
| 125 | YW125 | 09- | - | YT7B-BS | - | - |
| 125 | V-IXION | 13- | YTZ4V | - | - | - |
| 125 | XEON RC | 12 | YTZ5S | - | - | - |
| 125 | Zuma 125 | 09-12 | - | YT7B-BS | - | - |
| 135 | AT135 Cast | - | YTZ5S | - | - | - |
| 135 | JT135, T135FI | 07 | YTZ5S | - | - | - |
| 135 | RX KING SERIES | 04 | - | - | YB3L-B-BA | - |
| 135 | RX-KING | 00 | - | - | - | 6N6-3B-1 |
| 135 | RX-Z | 02 | - | - | - | 6N6-3B-1 |
| 135 | T135SE, SEC, HC | - | - | - | YB5L-B | 12N5-3B |
| 135 | T135FI | 09- | YTZ5S | - | - | - |
| 150 | FZ150 | - | YTZ5S | - | - | - |
| 150 | RX150 | 95 | - | - | YB3L-B | - |
| 150 | SR150 | 93-95 | - | - | YB7-A | - |
| 150 | XC150 Fly One R | 98 | - | YTX7A-BS | - | - |
| 150 | YP150 | 01 | - | - | YB7L-B | - |
| 150 | YP150, E | 09- | - | - | YB7L-B2 | - |
| 150 | YTZF-R15 | - | YTZ5S | - | - | - |
| 150 | YZF R15 | 14 | YTZ4V | - | - | - |
| 150 | XABRE 150 | 16 | YTZ4V | - | - | - |
| 155 | N-MAX | 15 | YTZ7V | - | - | - |
| 155 | NVX155 | - | YTZ7V | - | - | - |
| 155 | Smax | 15-16 | YTZ7S | - | - | - |
| 155 | Tricity 155 | 16- | YTZ7V | - | - | - |
| 155 | XC155 Majesty S | - | - | YT7B-BS(WC) | - | - |
| 175 | 175 Enduro | 69-71 | - | - | - | 6N2-2A-3 |
| 175 | CT1, CT1B, CT1C 175 Enduro | 69-71 | - | - | - | 6N2-2A-3 |
| 175 | CT2, CT3 175 Enduro | 72-73 | - | - | - | 6N4A-4D |

| CC | Model | Year | High Performance Maintenance Free | Maintenance Free VRLA | YuMicron | Conventional |
|-------------------------|-----------------------------|-------|-----------------------------------|-----------------------|----------|--------------|
| YAMAHA continued | | | | | | |
| 175 | DT175 | 07- | - | - | - | 6N6-3B-1 |
| 175 | DT175 Enduro | 74-76 | - | - | - | 6N4B-2A-3 |
| 175 | DT175 Enduro | 78-81 | - | - | - | 6N6-3B-1 |
| 180 | RT180G | 95 | - | - | - | 6N6-3B-1 |
| 180 | XC180 Cygnus | 93 | - | - | YB10L-A2 | - |
| 180 | XC180, D, Z Riva | 83-85 | - | - | YB10L-B | - |
| 180 | YP180E | 09- | - | - | YB7L-B2 | - |
| 185 | SR185, Exciter | 81-82 | - | - | YB7L-B | - |
| 200 | AG200E, F, G | 93- | - | - | - | 6N4B-2A-3 |
| 200 | AG200FE | - | YTZ7S | - | - | - |
| 200 | BW200 | 86-88 | - | - | YB7C-A | - |
| 200 | CS3B, CS3C | 70-71 | - | - | YB9L-A2 | - |
| 200 | CS5 | 72 | - | - | YB9L-A2 | - |
| 200 | DT200RE | 93 | - | - | YB3L-B | - |
| 200 | RD200 | 74-76 | - | - | YB9L-A2 | - |
| 200 | RD200, DX | 75-79 | - | - | - | 12N9-4B-1 |
| 200 | SDR200 | - | - | - | YB3L-B | - |
| 200 | TW200 | 87-16 | - | - | YB7C-A | - |
| 200 | TW200EV, V | 87- | - | - | YB7C-A | - |
| 200 | TW200W1, C, E | 07- | - | - | YB7C-A | - |
| 200 | XC200, Z Riva | 87-91 | - | - | YB10L-B2 | - |
| 200 | XT200 | 82-83 | - | - | - | 6N4A-4D |
| 200 | YCS1 | 68 | - | - | YB9L-A2 | - |
| 223 | SCORPIO Z | 3 | - | - | YB7B-B | - |
| 225 | TTR225 | 99-05 | - | - | YB7B-B | - |
| 225 | TW225E | - | - | - | YB7C-A | - |
| 225 | XT225 | 01-07 | YTZ7S | - | - | - |
| 225 | XT225 Serow | 92-00 | - | YTX7L-BS | - | - |
| 225 | XT225, E, EC, F, FG, G, GC | 93- | - | YTX7L-BS | - | - |
| 225 | XT225, V | 01-03 | YTZ7S | - | - | - |
| 230 | TTR230, T, V | 05- | - | YTX5L-BS | - | - |
| 230 | TTR230E | 06-16 | YTZ7S | YTX5L-BS | - | - |
| 250 | CP250, V | 05- | YTZ10S | - | - | - |
| 250 | Drag Star 250 | - | YTZ7S | - | - | - |
| 250 | DS6B, DS6C | 69-70 | - | - | YB5L-B | 12N5-3B |
| 250 | DS7 | 72 | - | - | - | 12N5.5A-3B |
| 250 | DT1 250 Enduro | 68 | - | - | - | 6N2-2A-3 |
| 250 | DT1B, DT1C, DT1E 250 Enduro | 69-71 | - | - | - | 6N2-2A-3 |
| 250 | DT2 250 Enduro | 72 | - | - | - | 6N4-2A-5 |
| 250 | DT250 Enduro | 74-76 | - | - | - | 6N4B-2A-3 |
| 250 | DT250 Enduro | 77-79 | - | - | - | 6N6-3B-1 |
| 250 | DT250MX | 77-81 | - | - | - | 6N6-3B-1 |
| 250 | DT3 250 Enduro | 73 | - | - | - | 6N4-2A-5 |
| 250 | Majesty | - | YTZ10S | - | - | - |
| 250 | Maxam | - | YTZ10S | - | - | - |
| 250 | Morphous | 06-07 | YTZ10S | - | - | - |
| 250 | R250 | 14- | YTZ8V | - | - | - |
| 250 | RD250, S | 73-79 | - | - | - | 12N5.5A-3B |
| 250 | RD250LC | 80-82 | - | - | - | 12N5.5-3B |
| 250 | SEROW250 | 05- | YTZ7S | - | - | - |
| 250 | SR250, E, ES, Exciter | 80-82 | - | - | YB12A-A | 12N12A-4A-1 |
| 250 | SRV250, G | 93- | - | YTX7A-BS | - | - |
| 250 | SRX250 | 87 | - | - | YB12A-A | 12N12A-4A-1 |
| 250 | TDR250 | 88-90 | - | - | YB5L-B | - |

World number one for motorcycle batteries

| CC | Model | Year | High Performance Maintenance Free | Maintenance Free VRLA | YuMicron | Conventional |
|-------------------------|-----------------------------|-------|-----------------------------------|-----------------------|----------|--------------|
| YAMAHA continued | | | | | | |
| 250 | Tricker | - | YTZ7S | - | - | - |
| 250 | TT250, RV | 99- | - | YT7B-BS | - | - |
| 250 | TTR250, V | 99-06 | - | YT7B-BS | - | - |
| 250 | TZR250 | 89-90 | - | - | YB5L-B | - |
| 250 | VP250 | 07- | - | YTX9-BS | - | - |
| 250 | WR250R, RY, RYC, X, XY, XYC | 08- | YTZ7S | - | - | - |
| 250 | WR250R | 14- | YTZ7S | - | - | - |
| 250 | WR250F, -S | 03-09 | YTZ7S | YTX5L-BS | - | - |
| 250 | WR250FR | 07 | YTZ7S | - | - | - |
| 250 | XG250 | 04- | YTZ7S | - | - | - |
| 250 | XMAX | - | - | YTX9-BS | - | - |
| 250 | XS250 | 77-80 | - | - | YB12A-A | - |
| 250 | XT250 | 84 | - | - | YB3L-B | - |
| 250 | XT250 | 80-83 | - | - | - | 6N6-3B-1 |
| 250 | XT250, X | 08-12 | YTZ7S | - | - | - |
| 250 | XT250V | 06 | - | YTX7L-BS | - | - |
| 250 | XTZ250 | 07- | - | YTX7L-BS | - | - |
| 250 | XV250 | 07 | - | - | YB10L-A2 | - |
| 250 | XV250YCR V Star 250 | 09-16 | - | - | YB10L-A2 | 12N10-3A-2 |
| 250 | XV250 Route 66 | 88-90 | - | - | YB10L-A2 | 12N10-3A-2 |
| 250 | XV250, H Virago | 95-03 | - | - | YB10L-A2 | 12N10-3A-2 |
| 250 | XV250, N, L, S Virago | 89-98 | - | - | YB10L-A2 | - |
| 250 | XVS250, S | 04- | YTZ7S | - | - | - |
| 250 | YBR250 | 07- | - | YTX7L-BS | - | - |
| 250 | YP250 | 07- | YTZ10S | - | - | - |
| 250 | YP250R | - | - | YTX9-BS | - | - |
| 250 | YP250RA | - | - | YTX9-BS | - | - |
| 250 | YP250 DX/ABS Majesty | 96-03 | - | YT7B-BS | - | - |
| 250 | YP250 Majesty | 00 | - | YT7B-BS | - | - |
| 250 | YP250, L, C, G | 04- | - | YT9B-BS | - | - |
| 250 | YP250, YP250R, YP250RA | 07- | - | YTX9-BS | - | - |
| 250 | YP250R | 07- | - | YTX9-BS | - | - |
| 250 | YS250 | 06- | - | YTX7L-BS | - | - |
| 250 | YZ250FX | 15- | YTZ7S(F) | - | - | - |
| 250 | YZF-R25 | 15- | YTZ8V | - | - | - |
| 250 | MT-25 | 15- | YTZ8V | - | - | - |
| 300 | VP300 | 04- | - | YTX9-BS | - | - |
| 320 | MT-03 | 15- | YTZ8V | - | - | - |
| 321 | YZF-R3 | 15- | YTZ8V | - | - | - |
| 350 | BW350, Big Wheel | 87-88 | - | - | YB12B-B2 | - |
| 350 | BW350E | 86-88 | - | - | YB7C-A | - |
| 350 | R3 | 69 | - | - | YB5L-B | 12N5-3B |
| 350 | R5, R5B, R5C | 70-72 | - | - | - | 12N5.5A-3B |
| 350 | RD350 | 73-75 | - | - | - | 12N5.5A-3B |
| 350 | RD350LC, LCF | 85 | - | - | YB5L-B | - |
| 350 | RD350LC, LCF | 80-84 | - | - | - | 12N5.5-3B |
| 350 | RD350LC-FH, FN, H, N | 86-90 | - | - | YB5L-B | - |
| 350 | RZ350 | 84-85 | - | - | - | 12N5.5-3B |
| 350 | TT350E, F | 93-94 | - | - | - | 6N2-2A |
| 350 | XT350, H, N | 85-00 | - | - | YB3L-B | - |
| 350 | YR2/C | 68 | - | - | - | 12N5.5-3B |
| 360 | DT360 Enduro | 74 | - | - | - | 6N4B-2A-3 |
| 360 | RT1, RT1B, 360 Enduro | 70-71 | - | - | - | 6N2-2A-3 |
| 360 | RT2, RT3, 360 Enduro | 72-73 | - | - | - | 6N4-2A-5 |

| CC | Model | Year | High Performance Maintenance Free | Maintenance Free VRLA | YuMicron | Conventional |
|-----|---|-------|-----------------------------------|-----------------------|-----------|--------------|
| 360 | XS360 | 76-78 | - | - | YB12A-A | 12N12A-4A-1 |
| 360 | XS360-2 | 77 | - | - | YB7L-B | 12N7-3B |
| 400 | DragStar XVS,XVS400,Classic,Classic 400 | - | - | YT12B-BS | - | - |
| 400 | DragStar XVS400 (EBL-VH02J/H602E) | 10- | YTZ10S | - | - | - |
| 400 | DragStar 400 DragStar Classic 400 | - | YTZ10S | - | - | - |
| 400 | DT400 Enduro | 75-76 | - | - | - | 6N4B-2A-3 |
| 400 | DT400 Enduro | 77-78 | - | - | - | 6N6-3B-1 |
| 400 | FZR400 (All) | 88-90 | - | - | YB12AL-A2 | - |
| 400 | FZR400RR, RRSP | 92- | - | YTX9-BS | - | - |
| 400 | RD400, S | 76-79 | - | - | - | 12N5.5A-3B |
| 400 | SR400 (FI) | 10- | - | YT4B-BS | - | - |
| 400 | XJR400R | 04- | - | YTX9-BS | - | - |
| 400 | XS400 (All) | 77-83 | - | - | YB12A-A | 12N12A-4A-1 |
| 400 | XV400 | 95 | - | - | YB12AL-A2 | - |
| 400 | XVS400, C | 04 | - | YT12B-BS | - | - |
| 400 | YP400, A, G, Majesty | 04-12 | - | YT9B-BS | - | - |
| 450 | WR450F | 03-16 | YTZ7S | - | - | - |
| 450 | YZ450FX | 16 | YTZ7S(F) | - | - | - |
| 500 | SR500 | 78-81 | - | - | YB7L-B | 12N7-3B |
| 500 | FXR500 | 93 | - | - | YB12AL-A2 | - |
| 500 | RD500LC | 84-85 | - | - | - | 12N5.5-3B |
| 500 | SR500 | 98- | - | YT4B-BS | - | - |
| 500 | SR500, SP | 78- | - | - | - | 12N7-3B |
| 500 | TMAX | 01- | - | YT9B-BS | - | - |
| 500 | TMAX | 11- | YTZ10S | - | - | - |
| 500 | TX500 | 73-74 | YTX14AHL-BS | - | YB14L-A2 | 12N14-3A |
| 500 | XP500, A, W (T-Max) | 01- | - | YT9B-BS | - | - |
| 500 | XP500, A, Y | 08-09 | YTZ10S | - | - | - |
| 500 | XP500 T-Max | 09-12 | YTZ10S | - | - | - |
| 500 | XS500, E | 75-78 | YTX14AHL-BS | - | YB14L-A2 | 12N14-3A |
| 500 | XT500 | 83-85 | - | - | - | 6N6-3B-1 |
| 500 | XT500 | 86-89 | - | - | YB3L-B | - |
| 500 | XT500E | 93- | - | YTX9-BS | - | - |
| 500 | XV500 Virago | 83 | - | - | YB12A-A | 12N12A-4A-1 |
| 535 | XV535 DX Virago | 87-99 | - | - | YB12AL-A2 | - |
| 530 | TMAX 530 | 11- | YTZ12S | - | - | - |
| 535 | XV535, H, N, S, SE Virago | 87-99 | - | - | YB12AL-A2 | - |
| 550 | XJ550 Maxim, R Seca | 81-83 | - | - | YB12A-A | 12N12A-4A-1 |
| 550 | XT550 | 82-83 | - | - | YB5L-B | 12N5-3B |
| 550 | XZ550R Virago | 82-83 | - | - | YB14L-A2 | - |
| 550 | XZ550R Vision | 82-83 | YTX14AHL-BS | - | YB14L-A2 | - |
| 550 | ZX 550 R | 83 | - | - | YB14L-A2 | - |
| 600 | FJ600 | 84-85 | - | - | YB12A-A | 12N12A-4A-1 |
| 600 | FZ600 | 86-88 | - | - | YB12A-A | 12N12A-4A-1 |
| 600 | FZ6, R | 05-16 | - | YT12B-BS | - | - |
| 600 | FZR600 | 89-93 | - | - | YB12AL-A2 | - |
| 600 | FZR600, E, RE, REC | 93- | - | - | YB12AL-A2 | - |
| 600 | FZR600R | 89-93 | - | - | YB12AL-A2 | - |
| 600 | FZR600R | 94-95 | - | YTX12-BS | - | - |
| 600 | FZS600, S, Fazer | 98-03 | - | YT12B-BS | - | - |
| 600 | SRX600, H, N | 86-90 | - | - | YB5L-B | 12N5-3B |
| 600 | TT600E | 94 | - | YTX9-BS | - | - |
| 600 | TT600RE | 04 | - | YT9B-BS | - | - |
| 600 | TT600S | 93 | YTX4L-BS | YT4L-BS | - | - |

Can't find your vehicle listed?
Visit www.yuasa.com for our latest application data

| CC | Model | Year | High Performance Maintenance Free | Maintenance Free VRLA | YuMicron | Conventional |
|-------------------------|-------------------------|-------|-----------------------------------|-----------------------|-----------|--------------|
| YAMAHA continued | | | | | | |
| 600 | TT600T | 86-88 | - | - | - | 6N4-2A-7 |
| 600 | TT600W | 86-92 | - | - | - | 6N4-2A-7 |
| 600 | XJ6, Deversion (EU) | -12 | - | YT12B-BS | - | - |
| 600 | XJ6N, NA, S, SA, SY | 09- | - | YT12B-BS | - | - |
| 600 | XJ600, H, N | 84-91 | - | - | YB12A-A | - |
| 600 | XJ600N | 94-99 | - | YTX9-BS | - | - |
| 600 | XJ600S | 09- | - | YT12B-BS | - | - |
| 600 | XJ600S Diversion | 92-02 | - | YTX9-BS | - | - |
| 600 | XJ600S Seca II | 92-98 | - | YTX9-BS | - | - |
| 600 | XT600 | 84-89 | - | - | YB5L-B | - |
| 600 | XT600E, EH, EN | 90-95 | - | YTX9-BS | - | - |
| 600 | XT600E, EH, EN, H, N, Z | 84-87 | - | - | YB5L-B | - |
| 600 | XT600KH | 91-95 | YTX4L-BS | YT4L-BS | - | - |
| 600 | XT600Z | 83-84 | - | - | YB12AL-A2 | - |
| 600 | YX600 Radian | 86-90 | - | - | YB12A-A | 12N12A-4A-1 |
| 600 | YZF600FGC, RG, RW | 95- | - | YTX12-BS | - | - |
| 600 | YZF600R, Thunder Cat | 95-07 | - | YTX12-BS | - | - |
| 600 | YZF-R6 | 99-00 | YTZ10S | YT12B-BS | - | - |
| 600 | YZF-R6 (Excl. R6S) | 06-16 | YTZ10S | - | - | - |
| 600 | YZF-R6, R6S | 01-07 | - | YT9B-BS | - | - |
| 600 | YZF-R6, S, SC, SV, Y | 01-05 | - | YT9B-BS | - | - |
| 650 | TX650 | 73 | - | - | YB12A-A | 12N12A-4A-1 |
| 650 | TX650 | 74 | YTX14AHL-BS | - | YB14L-A2 | 12N14-3A |
| 650 | X1 | 70-71 | - | - | - | 12N5.5-3B |
| 650 | X2 | 72 | - | - | - | 12N12A-4A-1 |
| 650 | XJ650 (All models) | 80-83 | - | - | YB12A-A | 12N12A-4A-1 |
| 650 | XS1 | 70-71 | - | - | - | 12N5.5-3B |
| 650 | XS2 | 72 | - | - | YB12A-A | 12N12A-4A-1 |
| 650 | XS650, -2, SE | 75-83 | YTX14AHL-BS | - | YB14L-A2 | 12N14-3A |
| 650 | XS650S Heritage Special | 78-83 | - | - | - | 12N14-3A |
| 650 | XVF600RT, C | 05 | - | YTX12-BS | - | - |
| 650 | XVS650 V-Star (All) | 98-16 | - | YT12B-BS* | - | - |
| 650 | XVS650, W, WC | 97- | - | YT12B-BS | - | - |
| 650 | XVS650A Drag Star Cla. | 99- | - | YT12B-BS | - | - |
| 650 | XVS650AY, V, VC | - | - | YT12B-BS | - | - |
| 660 | Burgman | - | - | YTX14-BS | - | - |
| 660 | MT03 | 06-12 | - | YT9B-BS | - | - |
| 660 | SZR660 | 96-98 | - | YTX9-BS | - | - |
| 660 | XT660X,R,Z, Tenere (EU) | 04-12 | YTZ10S | - | - | - |
| 660 | XTZ660 Tenere | 91-97 | - | YTX9-BS | - | - |
| 700 | MT07 | 14- | YTZ10S | - | - | - |
| 700 | FZ700, Fazer | 86-87 | YTX14AHL-BS | - | YB14L-A2 | - |
| 700 | FZX700 Fazer | 86-87 | - | - | YB14L-A2 | - |
| 700 | FZ-07 | 15-16 | YTZ10S | - | - | - |
| 700 | XJ700 Maxim, XJ700X | 85-86 | YTX14AHL-BS | - | YB14L-A2 | - |
| 700 | XJ700X/S/XS | 86 | - | - | YB14L-A2 | - |
| 700 | XV700 Virago | 84-87 | - | - | YB16AL-A2 | - |
| 700 | XV700C | 86-87 | - | - | YB16AL-A2 | - |
| 700 | XV700SS | 86 | - | - | YB16AL-A2 | - |
| 750 | FZ750, Genesis, FZR750 | 85-94 | YTX14AHL-BS | - | YB14L-A2 | - |
| 750 | FZR750 | 91- | - | YTX9-BS | - | - |
| 750 | FZR750RT Genesis | 88 | - | - | YB14L-A2 | - |
| 750 | FZX750 Fazer | 87-94 | - | - | YB14L-A2 | - |
| 750 | TX750 | 73-74 | YTX20HL-BS | YTX20L-BS | YB16L-B | - |

*YT12B-BS - Hold Down requires modification



| CC | Model | Year | High Performance Maintenance Free | Maintenance Free VRLA | YuMicron | Conventional |
|-------------------------|--------------------------------|-------|-----------------------------------|-----------------------|---------------|--------------|
| YAMAHA continued | | | | | | |
| 750 | XJ750 Maxim | 82-83 | - | - | SYB14L-A2 | - |
| 750 | XJ750 Maxim/K | 82-83 | - | - | YB14L-A2 | - |
| 750 | XJ750 Seca | 82-83 | - | - | YB14L-A2 | - |
| 750 | XJ750M Midnight Maxim | 83 | YTX14AHL-BS | - | YB14L-A2 | - |
| 750 | XJ750M Midnight Virago | 83 | - | - | YB14L-A2 | - |
| 750 | XJ750R Seca | 81-83 | - | - | SYB14L-A2 | - |
| 750 | XS750 (All) | 77-80 | YTX14AHL-BS | - | YB14L-A2 | 12N14-3A |
| 750 | XTZ750, H, N Sup. Tenere | 89-97 | - | - | YB14L-A2 | - |
| 750 | XV750 Virago (All) | 81-97 | - | - | YB16AL-A2 | - |
| 750 | YZF750R, SP | 93-97 | - | YTX12-BS | - | - |
| 750 | YZF-R7, OW02 | 99 | - | YT9B-BS | - | - |
| 800 | FZ8 | 11-12 | YTZ10S | - | - | - |
| 850 | FJ-09 | 15-16 | YTZ10S | - | - | - |
| 850 | FZ-09 | 14-16 | YTZ10S | - | - | - |
| 850 | MT09 | 14- | YTZ10S | - | - | - |
| 850 | TDM850 | 96-01 | - | YT12B-BS | - | - |
| 850 | TDM850, N | 91-00 | - | YTX12-BS | - | - |
| 850 | TRX850 | 96-99 | - | YTX12-BS | - | - |
| 850 | XS850 (All) | 80-81 | YTX14AHL-BS | - | YB14L-A2 | - |
| 900 | TDM900, A | 04-12 | - | YT12B-BS | - | - |
| 900 | XJ900, F | 83-91 | - | - | YB14L-A2 | - |
| 900 | XJ900P | - | - | YTX14-BS | - | - |
| 900 | XJ900R Seca | 83-92 | YTX14AHL-BS | - | YB14L-A2 | - |
| 900 | XJ900S Diversion | 95-02 | - | YTX14-BS | - | - |
| 900 | XSR900 | - | YTZ10S | - | - | - |
| 920 | XV920 Virago | 82 | YTX24HL-BS | - | SY50-N18L-AT | - |
| 920 | XV920M Midnight Virago | 83 | YTX24HL-BS | - | Y50-N18L-A-CX | Y50-N18L-A |
| 920 | XV920R Virago | 81-83 | YTX24HL-BS | - | Y50-N18L-A-CX | Y50-N18L-A |
| 950 | Bolt, Bolt R-SPEC, Bolt C-SPEC | 14- | YTZ14S | - | - | - |
| 950 | XVS950A | 09- | YTZ14S | - | - | - |
| 950 | XVS95CT,Y V Star 950, Tourer | 09-16 | YTZ14S | - | - | - |
| 1000 | FZ1-N, S, SA | 06- | YTZ14S | - | - | - |
| 1000 | FZ1 Fazer | 10- | YTZ14S | - | - | - |
| 1000 | FZ1 Fazer GT | 11- | YTZ14S | - | - | - |
| 1000 | FZR1000 | 87-90 | YTX14AHL-BS | - | YB14L-A2 | - |
| 1000 | FZR1000 | 91-95 | YTX14H-BS | YTX14-BS | - | - |
| 1000 | FZR1000 Exup | 89-91 | - | - | YB14L-A2 | - |
| 1000 | FZR1000 Exup | 92-95 | - | YTX14-BS | - | - |
| 1000 | FZR1000 Genesis | 87-91 | - | - | YB14L-A2 | - |
| 1000 | FZS1000, S, T, FZ1 | 01-05 | - | YT14B-BS | - | - |
| 1000 | FZS1000 FZ1 | 06-15 | YTZ14S | - | - | - |
| 1000 | GTS1000, A | 93-97 | - | YTX14-BS | - | - |
| 1000 | XV1000 Virago | 84-85 | - | - | Y50-N18L-A-CX | Y50-N18L-A |
| 1000 | XV1000SE Midnight Sp. | 83 | - | - | Y50-N18L-A | - |
| 1000 | XV1000SE Virago | 86-87 | - | - | Y50-N18L-A | - |
| 1000 | XV1000TR.1 | -92 | - | - | Y50-N18L-A | - |
| 1000 | YTF-R1, W, WC | 04-12 | YTZ10S | - | - | - |
| 1000 | YZF1000R, Thunderace | 96-01 | YTX14H-BS | YTX14-BS | - | - |
| 1000 | YZF-R1, Y, YC | 04-09 | YTZ10S | - | - | - |
| 1000 | YZF-R1 | 98-03 | - | YT12B-BS | - | - |
| 1000 | YZF-R1 LEV | 06 | YTZ10S | - | - | - |
| 1000 | YZF-R1, M, S | 16 | YTZ7S | - | - | - |
| 1000 | YZF-R1S | 06 | YTZ10S | - | - | - |
| 1100 | BT1100 | 02- | - | YT14B-BS | - | - |

World number one for motorcycle batteries

| CC | Model | Year | High Performance Maintenance Free | Maintenance Free VRLA | YuMicron | Conventional |
|-------------------------|--|-------|-----------------------------------|-----------------------|---------------|--------------|
| YAMAHA continued | | | | | | |
| 1100 | FJ1100 | 84-92 | YTX14AHL-BS | - | YB14L-A2 | 12N14-3A |
| 1100 | XJ1100 Maxim | 82 | YTX24HL-BS | - | SY50-N18L-AT | - |
| 1100 | XS1100 (All) | 78-92 | YTX24HL-BS | - | Y50-N18L-A-CX | Y50-N18L-A |
| 1100 | XV1100 | 89-98 | - | - | SY50-N18L-AT | - |
| 1100 | XV1100 Virago | 86-99 | YTX24HL-BS | - | Y50-N18L-A-CX | Y50-N18L-A |
| 1100 | XV1100G, GC | 95 | - | - | Y50-N18L-A | - |
| 1100 | XVS1100 | 99- | - | YT14B-BS | - | - |
| 1100 | XVS1100 Drag Star | 99-00 | - | YT14B-BS | - | - |
| 1100 | XVS1100 V-Star (All) | 99-07 | - | YT14B-BS | - | - |
| 1100 | XVS1100A, W, WC | 01- | - | YT14B-BS | - | - |
| 1100 | YVX11AWY, AWYC, AY | 09- | - | YT14B-BS | - | - |
| 1200 | FJ1200 | 86-90 | YTX14AHL-BS | - | YB14L-A2 | - |
| 1200 | FJ1200 (All) | 91-93 | YTX14H-BS | YTX14-BS | - | - |
| 1200 | VMX1200 V MAX | 85-07 | - | - | YB16AL-A2 | - |
| 1200 | XJR1200, SP | 95-98 | - | YTX14-BS | - | - |
| 1200 | XT1200Z Super Tenere | 12-16 | YTZ12S | - | - | - |
| 1200 | XVZ12 Venture/Royale | 83-85 | YTX24HL-BS | - | SY50-N18L-AT | - |
| 1300 | FJR1300, A, ES | 03- | - | YT14B-BS | - | - |
| 1300 | STRYKER 1300 | 09-15 | - | YTX20L-BS | - | - |
| 1300 | XJR1300 (EU) | 07-15 | YTZ14S | - | - | - |
| 1300 | XJR1300 | - | YTZ14S | - | - | - |
| 1300 | XJR1300, SP | 99- | - | YT14B-BS | - | - |
| 1300 | XVS1300A, AY | 07- | - | YTX20L-BS | - | - |
| 1300 | XVS13AY V Star 1300, Stryker | 09-16 | YTX20HL-BS* | YTX20L-BS | - | - |
| 1300 | XVZ13CT, CTS | 09- | YTX20HL-BS | YTX20L-BS | - | - |
| 1300 | XVZ13 Royal Star/Venture (All) | 96-13 | YTX20HL-BS | YTX20L-BS | - | - |
| 1300 | XVZ13 Venture/Royale | 86-93 | YTX24HL-BS | - | SY50-N18L-AT | - |
| 1300 | XVZ1300 AT Tour Classic | 99- | - | YTX20L-BS | - | - |
| 1300 | XVZ1300 TD | 89-91 | - | - | SY50-N18L-AT | - |
| 1300 | XVZ1300A Royal Star | 96- | - | YTX20L-BS | - | - |
| 1300 | XVZ1300TF Royal Star | 00- | - | YTX20L-BS | - | - |
| 1600 | XV1600 Road Star | 99-03 | YTX20HL-BS | YTX20L-BS | - | - |
| 1600 | XV1600A Wild Star | 00- | - | YTX20L-BS | - | - |
| 1700 | MT-01 (EU) | 05-12 | - | YT14B-BS | - | - |
| 1700 | SILVERADO 1700 | 04-07 | - | YTX20L-BS | - | - |
| 1700 | XV1700A Road Star, Silverado | 04-07 | YTX20HL-BS | YTX20L-BS | - | - |
| 1700 | XV1700ATMV, AV, AVC | - | - | YTX20L-BS | - | - |
| 1700 | XV1700P Road Star Warrior | 02-09 | - | YT14B-BS | - | - |
| 1700 | XV1700PC, CMV | 02- | - | YT14B-BS | - | - |
| 1700 | XV17AWY, AWYC, ATY, ATYC, ATY, ASY, ASYC | - | - | - | - | - |
| 1700 | VMAX | 09- | YTZ14S | - | - | - |
| 1854 | Roadliner, Stratoliner | 06-14 | - | YT14B-BS | - | - |
| 1854 | Raider, Raider S | 08-16 | - | YT14B-BS | - | - |
| 1854 | XV19CSY, CSYC, CY, CYC | 09- | - | YT14B-BS | - | - |
| 1900 | XV1900, A, CT | 07- | - | YT14B-BS | - | - |
| 1900 | XV19SV, SVC, CTSV | 06 | - | YT14B-BS | - | - |
| ZengChengHaiLi | | | | | | |
| 100 | HJ100-3 | - | - | - | YB5L-B | - |
| 100 | HJ100T-A | - | - | YTX7A-BS | - | - |
| 100 | HJ100T-E | - | - | YTX7A-BS | - | - |
| 125 | HJ125 | - | - | - | YB7-A | 12N7A-3A |
| 125 | HJ125-2, 3, 5, 9, 10, 15, 18 | - | - | - | - | 12N9-4B-1 |

*YTX20HL-BS - Hold Down requires modification



| CC | Model | Year | High Performance Maintenance Free | Maintenance Free VRLA | YuMicron | Conventional |
|---------------------------------|-------------------------|------|-----------------------------------|-----------------------|----------|--------------|
| ZengChengHaiLi continued | | | | | | |
| 125 | HJ125-7, 6, 6A | - | - | - | YB7-A | - |
| 125 | HJ125T, -3, 8, B, D, 2D | - | - | YTX7A-BS | - | - |
| 125 | HJ125T | - | - | - | YB5L-B | - |
| 150 | HJ150-9, 10 | - | - | - | - | 12N9-4B-1 |
| 150 | HJ150ST | - | - | YTX9-BS | - | - |
| 250 | HJ250 | - | - | - | - | 12N9-4B-1 |
| ZongShen Piaggio | | | | | | |
| 50 | FLY-50 | - | - | - | YB9-B | - |
| 50 | ZIP50 / 50QT | - | - | YTX9-BS | - | - |
| 50 | ZIP50 | - | - | - | YB4L-B | - |
| 100 | ZS100-6 | - | - | - | - | 6N4-2A |
| 100 | BYQ100T-ZE | - | - | YTX7A-BS | - | - |
| 110 | LZX110 | - | - | - | YB5L-B | - |
| 110 | ZS110-20 | - | - | - | YB6L-B | - |
| 125 | LZX125-2 | - | - | - | - | 12N7-3B |
| 125 | LZX125-4 | - | - | - | - | 12N9-4B-1 |
| 125 | ZS125 | - | - | - | - | 12N7-4A |
| 125 | ZS125-65 | - | - | YTX7L-BS | - | - |
| 125 | ZS125T-2 | - | - | - | YB6L-B | - |
| 125 | BYQ125-2E | - | - | - | - | 12N9-4B-1 |
| 150 | ZS150-15 | - | - | YTX7A-BS | - | - |
| ZUNDAPP | | | | | | |
| 125 | GS125 | - | - | - | - | 6N11A-3A |
| 125 | KS125 | - | - | - | - | 6N11A-3A |
| 175 | KS175 | - | - | - | - | 6N11A-3A |
| 850 | K850 Super | - | - | - | YB9L-B | - |

Can't find your vehicle listed?
Visit www.yuasa.com for our latest application data

| CC | Model | Year | High Performance Maintenance Free | Maintenance Free VRLA | YuMicron | Conventional |
|----------------------|-----------------------------------|-------|-----------------------------------|-----------------------|---------------|--------------|
| AEON (BENZAI) | | | | | | |
| 50 | Cobra/CX-Sport 50 | All | - | YTX4L-BS | - | - |
| 90 | Cobra/CX-Sport 90 | All | - | YTX4L-BS | - | - |
| 100 | Cobra/CX-Sport 100 | All | - | YTX4L-BS | - | - |
| ARCTIC CAT | | | | | | |
| 50 | DVX50 | 06-10 | YTZ7S | YTX5L-BS | - | - |
| 90 | All Models | -06 | - | YTX4L-BS | - | - |
| 90 | 90, 90 Utility | -16 | YTZ7S | YTX5L-BS | - | - |
| 90 | DVX90 | 06-16 | YTZ7S | YTX5L-BS | - | - |
| 150 | 150 | -16 | - | YTX9-BS | - | - |
| 250 | All Models | -10 | - | YTX12-BS | - | - |
| 250 | DVX250, 2x4 | 06 | - | YTX12-BS | - | - |
| 300 | All Models | All | YTX14AHL-BS | - | YB14L-A2 | - |
| 300 | DVX300 | 09-13 | - | YTX12-BS | - | - |
| 366 | 366 | 08-12 | - | - | YB14-A2 | - |
| 400 | All Models | All | YTX14AH-BS | - | YB14-A2 | - |
| 400 | DVX400 | All | - | YTX9-BS | - | - |
| 400 | TRV, CORE | 10-13 | YTX14AH-BS | - | YB14-A2 | - |
| 450 | 450, TRV, CORE | 11-12 | YTX20H-BS | - | - | - |
| 500 | All Other Models | -09 | YTX14AH-BS | - | YB14-A2 | - |
| 500 | Alterra | 16 | YTX20H-BS | - | - | - |
| 550 | TRV550 | 10-13 | YTX20H-BS | - | - | - |
| 650 | 4x4 Automatic | 04-06 | YTX14AH-BS | - | YB14-A2 | - |
| 400 | TRV400 | -09 | - | - | YB14-A2 | - |
| 650 | 650H1, TBX650, Mudpro | 05-12 | YTX14AH-BS | - | YB14-A2 | - |
| 700 | Alterra | 16 | YTX20H-BS | - | YB14A-2 | - |
| 700 | CORE, XT | 13-15 | YTX20H-BS | - | - | - |
| 700 | TRV, Mudpro, LTD, TBX, Diesel | 09-16 | YTX20H-BS | - | - | - |
| 700 | 700 | 06-08 | YTX14AH-BS | - | - | - |
| 1000 | Thundercat | -10 | YTX20H-BS | - | - | - |
| 1000 | Mudpro 1000H2, TRV, 1000i GT, XT | 10-16 | YTX20H-BS | - | - | - |
| BOMBARDIER | | | | | | |
| | See BRP (Can-Am) | - | - | - | - | - |
| BRP (Can-Am) | | | | | | |
| 50 | DS50, Quest | 02-06 | - | YTX4L-BS | - | - |
| 70 | DS70 | -15 | - | YTX4L-BS | - | - |
| 90 | DS90, DS90F, Quest | 02-16 | - | YTX4L-BS | - | - |
| 200 | Rally | 02-06 | YTX14AH-BS | - | YB14A-A2 | - |
| 250 | DS250 | 06-16 | - | YTX12-BS | - | - |
| 330 | Outlander 330 | 04-15 | - | YTX15L-BS | - | - |
| 400 | Outlander 400 | -15 | - | YTX15L-BS | - | - |
| 400 | Outlander 400, XT, MAX | 04-13 | YTX20HL-BS | YTX20L-BS | - | - |
| 450 | DS450 | -13 | - | YT7B-BS | - | - |
| 450 | Outlander | 16 | YTX20HL-BS | YTX20L-BS | - | - |
| 500 | Traxter (All Models), Quest | 99-05 | YTX20HL-BS-PW | - | YB16CL-B | - |
| 500 | Traxter (All Models), Quest (Opt) | 02-05 | YTX24HL-BS | - | Y50-N18L-A-CX | Y50-N18L-A |
| 500 | Outlander, MAX, Renegade | -16 | YTX20HL-BS | YTX20L-BS | - | - |
| 570 | Outlander, Renegade | 16 | YTX20HL-BS | YTX20L-BS | - | - |
| 650 | DS650 | 00-06 | - | YTX15L-BS | - | - |
| 650 | Quest | 02-05 | YTX20HL-BS-PW | - | YB16CL-B | - |
| 650 | Quest (Opt) | 02-05 | YTX24HL-BS | - | Y50-N18L-A-CX | Y50-N18L-A |

| CC | Model  | Year | High Performance Maintenance Free | Maintenance Free VRLA | YuMicron | Conventional |
|-------------------------------|---|-------|-----------------------------------|-----------------------|----------|--------------|
| BRP (Can-Am) continued | | | | | | |
| 650 | Outlander, 6X6 | -16 | YTX20HL-BS | YTX20L-BS | - | - |
| 660 | Outlander 660 EFI | 06 | YTX20HL-BS | YTX20L-BS | - | - |
| 800 | Outlander 800 EFI, MAX, Renegade | 06-15 | YTX20HL-BS | YTX20L-BS | - | - |
| 850 | Outlander, Renegade | 16 | YTX20HL-BS | YTX20L-BS | - | - |
| 1000 | Outlander 1000, Renegade, 6X6 | 12-16 | YTX20HL (WC) | YTX20L (WC) | - | - |
| CANNONDALE | | | | | | |
| All | All Models | 01-03 | - | YTX9-BS | - | - |
| E-TON | | | | | | |
| 50 | All models | 04-05 | YTZ7S | YTX5L-BS | - | - |
| 50 | AXL, TXL, NXL, RXL | 99-03 | - | YTX4L-BS | - | - |
| 70 | Viper 70 | -13 | YTZ7S | YTX5L-BS | - | - |
| 90 | All models | 04-13 | YTZ7S | YTX5L-BS | - | - |
| 90 | AXL, TXL, NXL, RXL | 99-03 | - | YTX4L-BS | - | - |
| 90 | DXL90 Sierra | 99-03 | - | YTX4L-BS | - | - |
| 150 | CXL150 Yukon II | 00-13 | - | YTX9-BS | - | - |
| 150 | YXL150 Yukon | 00-03 | - | YTX9-BS | - | - |
| 150 | Viper150R | -13 | - | YTX9-BS | - | - |
| 250 | Vector250 | -13 | - | YTX12-BS | - | - |
| HONDA | | | | | | |
| 90 | TRX90X, EX | 06-16 | YTZ7S | YTX5L-BS | - | - |
| 125 | ATC125M | 86-87 | - | YTX12-BS | - | - |
| 125 | ATC125M | 84-85 | - | - | YB9A-A | - |
| 125 | TRX125 Fourtrax | 87-88 | - | YTX9-BS | - | - |
| 125 | TRX125 Fourtrax | 85-86 | - | - | YB9A-A | - |
| 200 | ATC200 Big Red | 82-84 | YTX14AH-BS | - | YB14A-A2 | - |
| 200 | ATC200M | 84-85 | YTX14AH-BS | - | YB14A-A2 | - |
| 200 | TRX200 Fourtrax | 90-96 | - | YTX12-BS | - | - |
| 200 | TRX200 Fourtrax | 84 | YTX14AH-BS | - | YB14A-A2 | - |
| 200 | TRX200SX Fourtrax | 86-88 | - | YTX12-BS | - | - |
| 250 | ATC250ES Big Red | 85-87 | - | YTX12-BS | - | - |
| 250 | ATC250SX | 85-87 | - | YTX12-BS | - | - |
| 250 | TRX250 EX, TE, TM | 01-13 | - | YTX9-BS | - | - |
| 250 | TRX250 Fourtrax | 85-87 | - | YTX12-BS | - | - |
| 250 | TRX250 FourTrax Recon, ES | 97-07 | - | YTX12-BS | - | - |
| 250 | TRX250 Recon, ES | 97-03 | - | YTX12-BS | - | - |
| 250 | TR250TE, TM, FourTraxRecon | 97-16 | - | YTX12-BS | - | - |
| 250 | TRX250X, EX | 01-16 | - | YTX9-BS | - | - |
| 300 | TRX300 Fourtrax | 88-00 | YTX14H-BS | YTX14-BS | - | - |
| 300 | TRX300X, EX | 93-12 | - | YTX9-BS | - | - |
| 300 | TRX300FW Fourtrax 4x4 | 88-00 | YTX14H-BS | YTX14-BS | - | - |
| 350 | FL350R Odyssey | 85 | - | YTX12-BS | - | - |
| 350 | TRX350 Rancher | 00-06 | YTX14H-BS | YTX14-BS | - | - |
| 350 | TRX350, D Fourtrax 4x4 | 86-89 | YTX14H-BS | YTX14-BS | - | - |
| 400 | FL400R Pilot | 89-90 | YTX14H-BS | YTX14-BS | - | - |
| 400 | TRX400 Rancher AT | 04-06 | YTX14H-BS | YTX14-BS | - | - |
| 400 | TRX400X, EX, FourTrax, Sportrax | 99-13 | - | YTX9-BS | - | - |
| 400 | TRX400FW Foreman | 95-03 | YTX14H-BS | YTX14-BS | - | - |
| 420 | TRX420 Fourtrax Rancher 4x4 | -13 | YTX14H-BS | YTX14-BS | - | - |
| 420 | TRX420 Fourtrax Rancher 4x4 | 14-16 | GYZ16H | - | - | - |

World number one for motorcycle batteries

| CC | Model | Year | High Performance Maintenance Free | Maintenance Free VRLA | YuMicron | Conventional |
|------------------------|--------------------------------|-------|-----------------------------------|-----------------------|----------|--------------|
| HONDA continued | | | | | | |
| 420 | TRX420 Fourtrax Rancher 2x4 | 16 | YTX14H-BS | YTX14-BS | - | - |
| 450 | TRX450 Fourtrax Foreman S, ES | 98-04 | YTX14H-BS | YTX14-BS | - | - |
| 450 | TRX450ER, TRX450R | 06-13 | YTZ7S | - | - | - |
| 500 | TRX500FA Fourtrax Rubicon | 01-11 | YTX14H-BS | YTX14-BS | - | - |
| 500 | TRX500FE, FPE, FM, FPM | 05-11 | YTX14H-BS | YTX14-BS | - | - |
| 500 | TRX500FE, FPE, FM, FPM | 11-16 | GYZ16H | - | - | - |
| 500 | FourTrax Foreman ES, 4x4 | 05-09 | YTX14H-BS | YTX14-BS | - | - |
| 650 | TRX650 FourTrax Rincon (Std.) | 03-05 | YTX14H-BS | YTX14-BS | - | - |
| 650 | (Optional cold starting) | 03-04 | YTX20HL-BS | YTX20L-BS | - | - |
| 680 | TRX680FA Four Trax Rincon | 06-16 | YTX20HL-BS | YTX20L-BS | - | - |
| 700 | TRX700XX | 08-13 | - | YTX9-BS | - | - |
| 700 | MUV700 Big Red | 08-13 | YTX14H-BS | YTX14-BS | - | - |
| HYOSUNG | | | | | | |
| 450 | TE450S | -13 | - | YTX9-BS | - | - |
| JOHN DEERE | | | | | | |
| - | All Models | All | YTX20HL-BS-PW | - | YB16CL-B | - |
| KASEA | | | | | | |
| 50 | Mini Skyhawk | All | - | YTX4L-BS | - | - |
| 50 | Skyhawk 50 | All | YTZ7S | YTX4L-BS | - | - |
| 65 | KS, KU Models | All | - | YTX7A-BS | - | - |
| 90 | KS, KU Models | All | - | YTX7A-BS | - | - |
| 90 | Skyhawk 90 | All | YTZ7S | YTX7A-BS | - | - |
| 125 | KS, KU Models, Adventure Buggy | All | - | YTX7A-BS | - | - |
| 150 | Skyhawk 150, Adventure Buggy | All | - | YTX7A-BS | - | - |
| 170 | Skyhawk 170 | All | - | YTX7A-BS | - | - |
| 250 | Skyhawk 250 | All | - | YTX7A-BS | - | - |
| KAWASAKI | | | | | | |
| 50 | KFX50 | 07-16 | YTZ7S | YTX5L-BS | - | - |
| 80 | KSF80-A (KFX80) | 03-05 | YTZ7S | YTX5L-BS | - | - |
| 90 | KFX90 | 07-16 | YTZ7S | YTX5L-BS | - | - |
| 110 | KLF110-B Mojave | 87-88 | - | - | YB9L-A2 | - |
| 185 | KLF185-A Bayou | 85-88 | - | - | YB10L-B | - |
| 200 | KLT200-A, C | 81-84 | - | - | YB10L-B | - |
| 200 | KLT200-B, C | 83 | - | - | YB12A-A | - |
| 220 | KLF220-A Bayou | 88-02 | - | - | YB10A-A2 | - |
| 220 | KLF220-A Bayou (CN) | 92-02 | YTX14AH-BS | - | YB14A-A2 | - |
| 250 | KLF250-A Bayou | 03-12 | - | - | YB10A-A2 | - |
| 250 | KLF250-A Bayou (CN) | 03-05 | YTX14AH-BS | - | YB14A-A2 | - |
| 250 | KLT250-A | 82-83 | - | - | YB12A-A | - |
| 250 | KLT250-C Prairie | 83 | - | - | YB12A-A | - |
| 250 | KLT250-C Prairie | 84-85 | - | - | YB10L-B | - |
| 300 | KEF300-A Lakota | 95-00 | YTX14AH-BS | - | YB14A-A2 | - |
| 300 | KEF300-A Lakota Sport | 01-03 | YTX14AH-BS | - | YB14A-A2 | - |
| 300 | KEF300-B Lakota Sport | 01-03 | YTX14AH-BS | - | YB14A-A2 | - |
| 300 | KLF300-A Bayou | 86-87 | YTX20HL-BS-PW | - | YB16CL-B | - |
| 300 | KLF300-A Bayou | 86-87 | YTX20HL-BS-PW | - | YB16CL-B | - |
| 300 | KLF300-B Bayou | 88-04 | YTX14AH-BS | - | YB14A-A2 | - |
| 300 | KLF300-B Bayou (CN) | 92-99 | YTX20HL-BS-PW | - | YB16CL-B | - |

| CC | Model | Year | High Performance Maintenance Free | Maintenance Free VRLA | YuMicron | Conventional |
|---------------------------|-------------------------------------|-------|-----------------------------------|-----------------------|----------|--------------|
| KAWASAKI continued | | | | | | |
| 300 | KLF300-C Bayou 300 4x4 | 89-04 | YTX14AH-BS | - | YB14A-A2 | - |
| 300 | KLF300-C Bayou 300 4x4 (CN) | 92-05 | YTX20HL-BS-PW | - | YB16CL-B | - |
| 300 | KVF300-A Prairie 300, 4x4 | 99-02 | YTX14AH-BS | - | YB14A-A2 | - |
| 300 | KVF300-A Prairie 300, 4x4 (CN) | 99-01 | YTX20HL-BS-PW | - | YB16CL-B | - |
| 300 | KVF300-B Prairie 300, 4x4 | 99-02 | YTX14AH-BS | - | YB14A-A2 | - |
| 300 | KVF300-B Prairie 300, 4x4 (CN) | 99-02 | YTX20HL-BS-PW | - | YB16CL-B | - |
| 300 | KVF300 Brute Force | 13-16 | - | YTX12-BS | - | - |
| 360 | KVF360 Prairie | -13 | YTX14AH-BS | - | YB14A-A2 | - |
| 400 | KAF400, Mule 600, 610 | 05-12 | YTX14AH-BS | - | - | - |
| 400 | KLF400-B Bayou 400 4x4 | 93-00 | YTX20HL-BS-PW | - | YB16CL-B | - |
| 400 | KSF400-A (KFX400) | 03-06 | - | YTX9-BS | - | - |
| 400 | KVF400-A Prairie 400 4x4 | 97-00 | YTX14AH-BS | - | YB14A-A2 | - |
| 400 | KVF400-A Prairie 400 4x4 (CN) | 97-00 | YTX20HL-BS-PW | - | YB16CL-B | - |
| 400 | KVF400-B Prairie 400 4x4 | 98-00 | YTX14AH-BS | - | YB14A-A2 | - |
| 400 | KVF400-B Prairie 400 4x4 (CN) | 98-00 | YTX20HL-BS-PW | - | YB16CL-B | - |
| 400 | KVF400-C Prairie 400, 4x4 | 99-02 | YTX14AH-BS | - | YB14A-A2 | - |
| 400 | KVF400-C Prairie 400, 4x4 (CN) | 99-02 | - | KMX14-BS* | - | - |
| 400 | KVF400-D Prairie 400, 4x4 | 99-02 | YTX14AH-BS | - | YB14A-A2 | - |
| 400 | KVF400-D Prairie 400, 4x4 (CN) | 99-01 | - | KMX14-BS* | - | - |
| 450 | KFX450R | 08-13 | - | YTX7L-BS | - | - |
| 540 | KAF540, Mule 2010, 2020, 2030 | - | YTX20HL-BS-PW | - | YB16CL-B | - |
| 620 | KAF620, Mule 3010 4.4 | - | - | - | - | - |
| 620 | Advantage Classic | 03-07 | YTX20HL-BS | YTX20L-BS | - | - |
| 620 | Mule 4000 | -10 | Not available | - | - | - |
| 620 | KAF620F, Mule 4010 4x4 (US) | -12 | Not available | - | - | - |
| 620 | KAF620F, Mule 4010 4x4 (CN) | -12 | YTX20HL-BS | - | - | - |
| 620 | Mule 4010 Trans4x4 Diesel, Mule4000 | -12 | Not available | - | - | - |
| 650 | 4x4 Advantage Classic | 02-03 | - | KMX14-BS* | - | - |
| 650 | KVF650 Brute Force | 02-13 | - | KMX14-BS* | - | - |
| 700 | KVF650-A, B, D Prairie 700, 4X4 | 04-06 | - | KMX14-BS* | - | - |
| 700 | KFX700 | 03-10 | - | KMX14-BS* | - | - |
| 700 | KVF700-A, B, D Prairie 700, 4x4 | 04-06 | - | KMX14-BS* | - | - |
| 750 | KVF750 Brute Force | 05-16 | - | KMX14-BS* | - | - |
| 750 | Teryx All models (US) | 08-11 | Not Available | - | - | - |
| 750 | Teryx All Models (CN) | 08-11 | - | KMX14-BS* | - | - |
| 950 | KAF950, Mule 2510, 3010 Diesel | -10 | Not available | - | - | - |
| KTM | | | | | | |
| 450 | SX ATV | 08-12 | YTZ7S | YTX5L-BS | - | - |
| 450 | XC ATV | 08-12 | YTZ7S | YTX5L-BS | - | - |
| 505 | SX ATV | 08-13 | YTZ7S | YTX5L-BS | - | - |
| 505 | SX ATV | 08-09 | YTZ7S | YTX5L-BS | - | - |
| 525 | XC ATV | 08-13 | YTZ7S | YTX5L-BS | - | - |
| KYMCO | | | | | | |
| 50 | Mongoose 50 | All | - | YTX5L-BS | - | - |
| 50 | MXU 50 | - | - | YTX9-BS | - | - |
| 50 | Maxxer 50 | - | - | YTX5L-BS | - | - |
| 90 | Mongoose 90 | All | YTZ7S | YTX5L-BS | - | - |
| 90 | Maxxer 90 | - | - | YTX5L-BS | - | - |
| 125 | MXER | - | - | YTX9-BS | - | - |
| 150 | MXER 150 | 11- | - | YTX9-BS | - | - |
| 150 | MXU150 | All | - | YTX9-BS | - | - |

* Available from Kawasaki Main Dealer only

Can't find your vehicle listed?
Visit www.yuasa.com for our latest application data

| CC | Model | Year | High Performance Maintenance Free | Maintenance Free VRLA | YuMicron | Conventional |
|------------------------|--|-------|-----------------------------------|-----------------------|----------|--------------|
| KYMCO continued | | | | | | |
| 250 | Maxxer 250 | - | - | YTX12-BS | - | - |
| 250 | Mongoose, MXU | All | - | YTX12-BS | - | - |
| 250 | MXU 250 | - | - | YTX12-BS | - | - |
| 300 | Maxxer 300 | 11- | - | YTX12-BS | - | - |
| 300 | MXU300 | 11- | - | YTX12-BS | - | - |
| 300 | MXU300SD | All | - | YTX12-BS | - | - |
| 350 | Maxxer 400 | 11- | - | YTX14-BS | - | - |
| 350 | MXU 400 | 11- | - | - | YB14-A2 | - |
| 450 | Maxxer 450 / MXU450 | -16 | YTX20HL-BS | YTX20L-BS | - | - |
| 500 | UXV 500 | 11- | - | YTX20L-BS | - | - |
| 500 | MXU 500 | -13 | YTX20HL-BS | YTX20L-BS | - | - |
| 500 | MXU 500i | - | YTX20HL-BS | YTX20L-BS | - | - |
| 550 | MXU 550 | - | YTX20HL-BS | YTX20L-BS | - | - |
| 700 | MXU 700 | -16 | YTX20HL-BS | YTX20L-BS | - | - |
| 700 | UXV700 | 14- | YTX20HL-BS | YTX20L-BS | - | - |
| POLARIS | | | | | | |
| 50 | Predator (-07), Outlaw | 04-16 | YTZ7S | YTX5L-BS | - | - |
| 50 | Scrambler | 01-02 | - | YTX4L-BS | - | - |
| 50 | Scrambler | 03 | YTZ7S | YTX5L-BS | - | - |
| 90 | Predator, Sportsman, Outlaw | 03-13 | YTZ7S | YTX5L-BS | - | - |
| 90 | Scrambler, Sportsman | 01-02 | - | YTX4L-BS | - | - |
| 170 | Ranger RZR | -12 | - | YTX12-BS | - | - |
| 200 | Phoenix, Sawtooth | 05-13 | - | YTX12-BS | - | - |
| 250 | All Models | 06-08 | YTX14AH-BS | - | YB14A-A2 | - |
| 250 | All models | 85-05 | - | - | YB14A-A2 | - |
| 300 | Hawkeye, Sportsman 300 | 06-10 | - | - | YB14-B2 | - |
| 325 | ACE | 14-16 | GYZ32HL | - | YB14A-A2 | - |
| 325 | All Models | 87-02 | YTX14AH-BS | - | YB14A-A2 | - |
| 330 | Magnum, Trail | 03-13 | YTX14AH-BS | - | YB14A-A2 | - |
| 335 | Sportsman | 98-01 | YTX14AH-BS | - | YB14A-A2 | - |
| 400 | All Models | 94-12 | YTX14AH-BS | - | YB14A-A2 | - |
| 400 | Ranger 400 | 11-12 | YTX14AH-BS | - | - | - |
| 425 | All Models | 95-02 | YTX14AH-BS | - | YB14A-A2 | - |
| 450 | Diesel .445 Litre (primary) | 99-03 | YIX30L | YIX30L-BS | YB30L-B | - |
| 450 | Diesel .445 Litre (secondary) | 99-03 | YTX14AH-BS | - | YB14A-A2 | - |
| 450 | Outlaw 450 | 07-10 | - | YTX9-BS | - | - |
| 450 | Sportsman HO | 16 | YTX14AH (WC) | - | - | - |
| 500 | All Models (Excl. Predator, Sportsman) | 99-12 | YTX14AH-BS | - | YB14A-A2 | - |
| 500 | Predator, Outlaw | 03-06 | - | YTX9-BS | - | - |
| 500 | Ranger 6x6, 4x4 | 98-04 | - | YIX30L-BS | - | - |
| 500 | Ranger 4x4 | 04-10 | - | YIX30L-BS | - | - |
| 500 | Ranger 4x4 | 11-12 | YTX14AH-BS | - | - | - |
| 500 | Sportsman | -11 | YIX30L-BS | - | - | - |
| 500 | Sportsman HO | 96-13 | YTX14AH-BS | - | - | - |
| 525 | Outlaw 525 | 08-12 | - | YTX9-BS | - | - |
| 550 | Sportsman EPS, XP | 10-12 | - | YTX14AH-BS | - | - |
| 570 | Sportsman | 14-16 | YTX14AH-BS | - | YB14A-A2 | - |
| 570 | ACE, ACE SP | 15-16 | GYZ32HL | - | YB14A-A2 | - |
| 600 | Sportsman | 04-05 | YIX30L-BS | - | YB30L-B | - |
| 700 | Ranger 6x6, 4x4 | 06-10 | - | YIX30L-BS | - | - |
| 700 | Sportsman, Military | 02-08 | YIX30L-BS | - | YB30L-B | - |
| 700 | Sportsman | -10 | YIX30L-BS | - | - | - |

| CC | Model | Year | High Performance Maintenance Free | Maintenance Free VRLA | YuMicron | Conventional |
|--------------------------|--------------------------------|-------|-----------------------------------|-----------------------|------------|--------------|
| POLARIS continued | | | | | | |
| 800 | Sportsman | 05-14 | YTX20HL | - | - | - |
| 800 | Ranger RZR | 09-12 | YTX20HL-BS | - | - | - |
| 800 | Ranger RZR 4 | 10-12 | - | YIX30L-BS | - | - |
| 800 | Ranger | 10-12 | - | YIX30L-BS | - | - |
| 900 | ACE SP | 16 | GYZ32HL | - | - | - |
| QIANJIANG | | | | | | |
| 100 | ATV100 | - | - | YTX4L-BS | - | - |
| 50 | ATV50 | - | - | YTX4L-BS | - | - |
| SUZUKI | | | | | | |
| 50 | LT-Z50 QuadSport | 06-12 | YTZ7S | YTX5L-BS | - | - |
| 80 | LT80 QuadSport 80 | 87-06 | YTZ7S | YTX5L-BS | - | - |
| 90 | LT-Z90 QuadSport | 07-12 | YTZ7S | YTX5L-BS | - | - |
| 160 | LT160 E QuadRunner | 89-04 | - | - | YB9A-A | - |
| 160 | LT-F160 QuadRunner | 91-00 | - | - | YB9A-A | - |
| 230 | LT230E QuadRunner | 87 | Not available | - | - | - |
| 230 | LT230E QuadRunner | 88-93 | - | YTX12-BS | - | - |
| 230 | LT230GE QuadRunner | 85-86 | - | - | YB10A-A2 | - |
| 230 | LT-F230 QuadRunner | 86-87 | - | - | YB10A-A2 | - |
| 250 | LT250EF QuadRunner | 85-86 | - | - | Y50-N18A-A | - |
| 250 | LT-4WD QuadRunner | 87-99 | YTX14AH-BS | - | YB14A-A2 | - |
| 250 | LT-4WD QuadRunner (Opt) | 87-99 | - | - | Y50-N18A-A | - |
| 250 | LT-F250 QuadRunner | 88-01 | YTX14AH-BS | - | YB14A-A2 | - |
| 250 | LT-F250 QuadRunner (Opt) | 88-01 | - | - | Y50-N18A-A | - |
| 250 | LT-F250, Ozark | 02-16 | - | YTX12-BS | - | - |
| 250 | LT-F250F QuadRunner | 99-02 | YTX14AH-BS | - | YB14A-A2 | - |
| 250 | LT-F250F QuadRunner (CN, Opt) | 99-02 | - | - | Y50-N18A-A | - |
| 250 | LT-Z250 QuadSport | 04-12 | - | YTX12-BS | - | - |
| 280 | LT-F4WDX KingQuad | 91-99 | YTX14AH-BS | - | YB14A-A2 | - |
| 280 | LT-F4WDX KingQuad (CN, Opt) | 91-99 | - | - | Y50-N18A-A | - |
| 300 | LT-F4WDX KingQuad | 99-02 | - | - | YB14A-A2 | - |
| 300 | LT-F4WDX KingQuad (Opt) | 99-02 | - | - | Y50-N18A-A | - |
| 300 | LT300E QuadRunner 300E | 87-89 | YTX14AH-BS | - | YB14A-A2 | - |
| 300 | LT-F300F KingQuad | 99-02 | YTX14AH-BS | - | YB14A-A2 | - |
| 300 | LT-F300F KingQuad (CN, Opt) | 99-02 | - | - | Y50-N18A-A | - |
| 400 | LT-A400 Eiger 2WD, F Eiger 4WD | 02-07 | YTX14H-BS | YTX14-BS | - | - |
| 400 | LT-F400 Eiger 2WD, F Eiger 4WD | 02-07 | YTX14H-BS | YTX14-BS | - | - |
| 400 | LT-Z400 QuadSport | 03-16 | - | YTX9-BS | - | - |
| 400 | LT-A400F King Quad | -16 | YTX14H-BS | YTX14-BS | - | - |
| 450 | LT-A450X King Quad | 07-12 | YTX14H-BS | YTX14-BS | - | - |
| 450 | LT-R450 QuadRacer | 06-10 | YTZ10S | YTX7A-BS | - | - |
| 500 | LT-A500 King Quad | -16 | YTX20CH-BS | - | - | - |
| 500 | LT-A500F QuadMaster | 00-01 | - | YTX16-BS-1 | - | - |
| 500 | LT-A500F Vinson 4WD | 04-07 | YTX20CH-BS | - | - | - |
| 500 | LT-A500F Vinson 4WD | 02-03 | YTX20CH-BS | YTX16-BS | - | - |
| 500 | LT-F500F Vinson Manual 4WD | 04-07 | YTX20CH-BS | - | - | - |
| 500 | LT-F500F Vinson Manual 4WD | 03 | YTX20CH-BS | YTX16-BS | - | - |
| 700 | LT700 Twin Peaks | 04- | YTX20CH-BS | - | - | - |
| 700 | LT-A700X King Quad | 05-07 | YTX20CH-BS | - | - | - |
| 700 | LT-V700F Twin Peaks | 04-05 | YTX14H-BS | YTX14-BS | - | - |
| 750 | LT-A750 King Quad | 07-16 | YTX20CH-BS | - | - | - |

World number one for motorcycle batteries

| CC | Model | Year | High Performance Maintenance Free | Maintenance Free VRLA | YuMicron | Conventional |
|---------------|--------------------------|-------|-----------------------------------|-----------------------|----------|--------------|
| YAMAHA | | | | | | |
| 50 | YFM50 Raptor | 04-09 | - | - | - | 12N7D-3B |
| 80 | YFM80 Badger | 85-01 | - | - | - | 12N7D-3B |
| 80 | YFM80 Grizzly | 05-08 | - | - | - | 12N7D-3B |
| 80 | YFM80R Raptor | 02-08 | - | - | - | 12N7D-3B |
| 90 | YFM90R Raptor | 09-16 | YTZ7S | YTX5L-BS | - | - |
| 100 | YFM100 Champ | 87-91 | - | - | - | 12N7D-3B |
| 125 | YFA-1 Breeze | 89-04 | - | - | YB12C-A | - |
| 125 | YFM125A, G | 09- | - | - | - | - |
| 125 | YFM125S, G | 04-13 | - | - | YB12C-A | - |
| 125 | YFM12R, Raptor | 11-13 | YTZ7S | - | - | - |
| 200 | YFM200 Moto-4 | 85 | YTX14AH-BS | - | YB14A-A1 | - |
| 200 | YFM200, DX Moto 4 | 85-89 | YTX14AH-BS | - | YB14A-A1 | - |
| 200 | YTM200, E, ER Tri Moto | 83-85 | YTX14AH-BS | - | YB14A-A1 | - |
| 225 | YFM225 Moto 4 | 86-88 | YTX14AH-BS | - | YB14A-A1 | - |
| 225 | YTM225DR Tri Moto | 85-86 | YTX14AH-BS | - | YB14A-A1 | - |
| 225 | YTM225DR, DX Tri-Moto | 83-86 | YTX14AH-BS | - | YB14A-A1 | - |
| 225 | YTM225DX Tri Moto | 83-85 | YTX14AH-BS | - | YB14A-A1 | - |
| 230 | YFM25BY | 09- | - | - | YB14A-A2 | - |
| 230 | YFU-1/T Pro-Hauler | 89 | YTX14AH-BS | - | YB14A-A1 | - |
| 250 | YFB250, F Timber Wolf | 92-00 | - | - | YB12C-A | - |
| 250 | YFM25 Bear Tracker | 99-04 | YTX14AH-BS | - | YB14A-A2 | - |
| 250 | YFM250 Moto 4 | 89-91 | YTX14AH-BS | - | YB14A-A1 | - |
| 250 | YFM25B Big Bear | 07-10 | YTX14AH-BS | - | YB14A-A2 | - |
| 250 | YFM25B Bruin | 05-06 | YTX14AH-BS | - | YB14A-A2 | - |
| 250 | YFM25RY, RSEY | 09- | YTZ7S | - | - | - |
| 250 | YFM25R Raptor,R | 08-13 | YTZ7S | - | - | - |
| 300 | Grizzly 300 Automatic | 11-13 | - | YTX12-BS | - | - |
| 350 | YFM 350RV Raptor | 04-05 | YTZ10S | - | - | - |
| 350 | YFM350 | 07-09 | YTZ10S | - | - | - |
| 350 | YFM350A, FWA, FWAN, AS | 07-09 | YTX14AH-BS | - | - | - |
| 350 | YFM35B Bruin | 04-06 | YTX14AH-BS | - | - | - |
| 350 | YFM35ER Moto 4 | 87-95 | YTX14AH-BS | - | YB14A-A1 | - |
| 350 | YFM35F, U Big Bear | 87-99 | YTX14AH-BS | - | YB14A-A1 | - |
| 350 | YFM35FW Big Bear 4WD | 87-99 | YTX14AH-BS | - | YB14A-A1 | - |
| 350 | YFM30FX Wolverine | 95-05 | - | - | YB12C-A | - |
| 350 | YFM35FX Wolverine | 06-10 | YTX14AH-BS | - | - | - |
| 350 | YFM35FG Grizzly | 07-13 | YTX14AH-BS | - | - | - |
| 350 | YFM35R Raptor | 04-13 | YTZ10S | - | - | - |
| 350 | YFM35U Big Bear 2WD | 87-99 | YTX14AH-BS | - | YB14A-A1 | - |
| 350 | YFM35X Warrior | 87-03 | - | - | YB12C-A | - |
| 350 | YFM35XY | 09- | YTX14AH | - | - | - |
| 350 | YFP35 TerraPro | 88 | YTX14AH-BS | - | YB14A-A1 | - |
| 400 | YF40FG Grizzly | 07-08 | YTX20HL-BS | YTX20L-BS | - | - |
| 400 | YFM40FB Big Bear | 00-12 | YTX20HL-BS | YTX20L-BS | - | - |
| 400 | YFM40FG Grizzly | 07-08 | YTX14AH-BS | - | - | - |
| 400 | YFM40FW Kodiak | 93-95 | YTX14AH-BS | - | YB14A-A1 | - |
| 400 | YFM40FW Kodiak/Automatic | 03-06 | YTX14AH-BS | - | - | - |
| 400 | YFM40FW Kodiak/Automatic | 96-02 | YTX20HL-BS | YTX20L-BS | - | - |
| 400 | YFM40FWN Big Bear | 00-03 | YTX20HL-BS | YTX20L-BS | - | - |
| 400 | YFM40N Big Bear 2WD | 00-03 | YTX20HL-BS | YTX20L-BS | - | - |
| 450 | YFM45FG Grizzly | 07-13 | YTX14AH-BS | - | - | - |
| 450 | YFM45FW Automatic | 03-09 | YTX20HL-BS | YTX20L-BS | - | - |
| 450 | YFM45FX Wolverine | 03-10 | YTX20HL-BS | YTX20L-BS | - | - |

| CC | Model |  | Year | High Performance Maintenance Free | Maintenance Free VRLA | YuMicron | Conventional |
|-------------------------|------------------|---|-------|-----------------------------------|-----------------------|----------|--------------|
| YAMAHA continued | | | | | | | |
| 450 | YFZ450 | | 04-13 | - | YT7B-BS | - | - |
| 450 | YFZ450X | | -12 | - | YT7B-BS | - | - |
| 450 | YZF450R, X | | 09-16 | YTZ7S | - | - | - |
| 450 | YFZ450V | | -09 | - | YT7B-BS | - | - |
| 550 | YFM5FGPY, GPSEY | | 09- | YTX20HL-BS | YTX20L-BS | - | - |
| 550 | YMF5FG Grizzly | | -13 | YTX20HL-BS | YTX20L-BS | - | - |
| 550 | YFM550G, GY | | 09- | YTX20HL-BS | YTX20L-BS | - | - |
| 550 | YMF550 Grizzly | | -09 | YTX20HL-BS | - | - | - |
| 600 | YFM600FW Grizzly | | 98-01 | YTX20HL-BS | YTX20L-BS | - | - |
| 600 | YFV600FW Grizzly | | 98-01 | YTX20HL-BS | YTX20L-BS | - | - |
| 660 | YFM66FA Grizzly | | 02-08 | YTX20HL-BS | YTX20L-BS | - | - |
| 660 | YFM66R Raptor | | 01-05 | YTX14H-BS | YTX14-BS | - | - |
| 700 | KODIAK EPS | | 16 | YTX20HL-BS | YTX20L-BS | - | - |
| 700 | YFM7FG Grizzly | | 07-16 | YTX20HL-BS | YTX20L-BS | - | - |
| 700 | YFM70R Raptor | | 06-13 | - | YT9B-BS | - | - |
| 700 | YFM70RY | | 09- | - | YT9B-BS | - | - |
| 700 | YFM700FWA | | 09- | YTX20HL-BS | YTX20L-BS | - | - |

Can't find your vehicle listed?
 Visit www.yuasa.com for our latest application data

| CC | Model  | Year | High Performance Maintenance Free | Maintenance Free VRLA | YuMicron | Conventional |
|------------------|---|-------|-----------------------------------|-----------------------|---------------|--------------|
| ARTIC CAT | | | | | | |
| 550 | Prowler 550 | -09 | YTX24HL-BS | - | - | - |
| 550 | Prowler 550 | 10-13 | YIX30L-BS | - | YB30L-B | - |
| 570 | F570, T570, Bearcat | 08-12 | - | - | YB18-A | - |
| 600 | ZR 6000 | 14-15 | YTX20H-BS | - | - | - |
| 650 | Prowler 650 | 06-09 | YTX24HL-BS | - | Y50-N18L-A-CX | - |
| 700 | Prowler 700 | 09 | YTX24HL-BS | - | - | - |
| 700 | Prowler 700 | 10-13 | YIX30L-BS | - | YB30L-B | - |
| 800 | F8 LXR, F800, M800, XF800 | 07-13 | YTX20H-BS | - | - | - |
| 800 | ZR8000 | 14-16 | YTX20H-BS | - | - | - |
| 1000 | Mudpro 1000H2 | 10-12 | - | - | - | - |
| 1000 | Prowler 1000 | -13 | YIX30L-BS | - | YB30L-B | - |
| 1000 | Wildcat 1000, Wildcat 1000 LTD | -13 | YIX30L-BS | - | YB30L-B | - |
| 1100 | Z1, TZ1, F1100, M1100, Bearcat Z1 | 01-14 | YTX20H-BS | - | - | - |
| 1100 | ZR5000, ZR7000, ZR9000 | 14-16 | YTX20H-BS | - | - | - |
| 1100 | XF7000, 8000, 9000 | 14-16 | YTX20H-BS | - | - | - |
| 1100 | M 7000, 8000, 9000 | 14-16 | YTX20H-BS | - | - | - |
| 1100 | Pantera 7000 | 15-16 | YTX20H-BS | - | - | - |
| 1100 | Bearcat 5000, 7000 | 15-16 | YTX20H-BS | - | - | - |
| - | T500, T570 | -09 | - | - | YB18-A | - |
| - | 500cc & Over | 91-01 | - | - | YB18-A | - |
| - | All EFI Models 500cc & Over (W/O EI.-Starter) | 94-01 | - | - | YB7-A | - |
| - | All EFI Models 500cc & Over (W/O EI.-Starter) | 91-93 | - | - | YB14L-A2 | - |
| - | All EFI Models 500cc & Over | 91-01 | - | - | Y50-N18L-A-CX | - |
| - | all carburetor models | | | | | |
| - | All Models Less than 500cc | -93 | - | - | YB14L-A2 | - |
| - | All Models Less than 500cc | 94-01 | - | - | YB14-A2 | - |
| - | Bearcat 340, 440 | 95-00 | YTX14AH-BS | - | YB14-A2 | - |
| - | Bearcat 570 | 04-09 | YTX24HL-BS | - | Y50-N18L-A-CX | - |
| - | Bearcat 570, WT Turbo | 06-07 | YTX24HL-BS | - | - | - |
| - | Bearcat WT | 05-07 | YTX24HL-BS | - | - | - |
| - | Bearcat WT | 03-04 | YTX24HL-BS | - | Y50-N18L-A-CX | - |
| - | Bearcat WT | 95-02 | YTX20H-BS | YTX20-BS | YB18-A | - |
| - | Bearcat WT Turbo | 06-07 | YTX24HL-BS | - | - | - |
| - | Cheetah | 91-93 | YTX14AHL-BS | - | YB14L-A2 | - |
| - | Cheetah | 86-90 | - | - | YB16L-B | - |
| - | Cougar | 95-98 | YTX20H-BS | YTX20-BS | YB18-A | - |
| - | Cougar | 91-94 | YTX14AHL-BS | - | YB14L-A2 | - |
| - | Cougar | 85-90 | - | - | YB16L-B | - |
| - | Crossfire 500 | 07 | YTX20H-BS | - | - | - |
| - | Crossfire 600 | 06-07 | YTX20H-BS | - | - | - |
| - | Crossfire 700 | 06 | YTX20H-BS | - | - | - |
| - | El Tigre 5000 | 87-88 | YTX14AHL-BS | - | YB14L-A2 | - |
| - | EXT | 95-97 | - | - | - | 12N7-4A |
| - | EXT | 92-94 | YTX14AHL-BS | - | YB14L-A2 | - |
| - | EXT | 89-91 | - | - | YB16L-B | - |
| - | EXT (Carb) | 95-96 | YTX20H-BS | YTX20-BS | YB18-A | - |
| - | EXT (EFI) | 98 | YTX20H-BS | YTX20-BS | YB18-A | - |
| - | EXT (EFI) | 95-97 | - | - | - | 12N7-4A |
| - | EXT 600 | 97-98 | YTX20H-BS | YTX20-BS | YB18-A | - |
| - | EXT Dix (EFI) | 97-98 | YTX24HL-BS | - | Y50-N18L-A-CX | - |
| - | EXT Special | 91-92 | YTX14AHL-BS | - | YB14L-A2 | - |
| - | F6, F8, F1000 | 07-09 | YTX20H-BS | - | - | - |
| - | F5 | 07-09 | YTX20H-BS | YTX20-BS | YB18-A | - |

| CC | Model  | Year | High Performance Maintenance Free | Maintenance Free VRLA | YuMicron | Conventional |
|-----------------------------|---|-------|-----------------------------------|-----------------------|---------------|--------------|
| ARCTIC CAT continued | | | | | | |
| - | F5 LXR | 07-12 | - | - | YB18-A | - |
| - | Firecat | 03-06 | YTX24HL-BS | - | Y50-N18L-A-CX | - |
| - | Firecat, Jaguar | 07 | - | - | Y50-N18L-A-CX | - |
| - | Jag AFS | 89-91 | YTX14AHL-BS | - | YB14L-A2 | - |
| - | Jag AFS L/T | 89-93 | YTX14AHL-BS | - | YB14L-A2 | - |
| - | Jag Liquid | 96 | YTX14AH-BS | - | YB14-A2 | - |
| - | Jag Z | 94 | YTX14AH-BS | - | YB14-A2 | - |
| - | Jag Z | 93 | YTX14AHL-BS | - | YB14L-A2 | - |
| - | Jag, Jag Dlx | 94-99 | YTX14AH-BS | - | YB14-A2 | - |
| - | Jag, Jag Dlx | 85-93 | YTX14AHL-BS | - | YB14L-A2 | - |
| - | Jaguar | 07 | YTX20H-BS | - | - | - |
| - | King Cat 900 | 04-06 | YTX24HL-BS | - | Y50-N18L-A-CX | - |
| - | Lynx, M5, M6, M7 | 91-93 | YTX14AHL-BS | - | YB14L-A2 | - |
| - | Lynx, M5, M6, M7 | 91-93 | - | - | YB14L-A2 | - |
| - | M 5 | 05-06 | YTX20H-BS | - | - | - |
| - | M 6 | 05-07 | YTX20H-BS | - | - | - |
| - | M 7 | 05-06 | YTX20H-BS | - | - | - |
| - | Mountain Cat | 01 | YTX20H-BS | YTX20-BS | YB18-A | - |
| - | Mountain Cat 500 | 02 | YTX20H-BS | YTX20-BS | YB18-A | - |
| - | Mountain Cat 570 | 02-04 | YTX24HL-BS | - | Y50-N18L-A-CX | - |
| - | Mountain Cat 600 | 02-04 | YTX20H-BS | YTX20-BS | YB18-A | - |
| - | Mountain Cat 800 | 02-04 | YTX24HL-BS | - | Y50-N18L-A-CX | - |
| - | Mountain Cat 900 | 03-04 | YTX24HL-BS | - | Y50-N18L-A-CX | - |
| - | Mountain Cat 1000 | 02 | YTX20H-BS | YTX20-BS | YB18-A | - |
| - | Pantera | 99-01 | YTX20H-BS | YTX20-BS | YB18-A | - |
| - | Pantera | 95-98 | YTX24HL-BS | - | Y50-N18L-A-CX | - |
| - | Pantera | 94 | YTX20H-BS | YTX20-BS | YB18-A | - |
| - | Pantera | 86-93 | YTX14AHL-BS | - | YB14L-A2 | - |
| - | Pantera | 80-85 | - | - | YB16L-B | - |
| - | Pantera 550, 600 | 02-05 | YTX20H-BS | YTX20-BS | YB18-A | - |
| - | Pantera 800 | 02-04 | YTX24HL-BS | - | Y50-N18L-A-CX | - |
| - | Panther | 94-96 | YTX14AH-BS | - | YB14-A2 | - |
| - | Panther | 89-93 | YTX14AHL-BS | - | YB14L-A2 | - |
| - | Panther | 80-88 | - | - | YB16L-B | - |
| - | Panther 340 | 97-00 | YTX14AH-BS | - | YB14-A2 | - |
| - | Panther 370 | 01-07 | YTX14AH-BS | - | YB14-A2 | - |
| - | Panther 440 | 97-03 | YTX14AH-BS | - | YB14-A2 | - |
| - | Panther 550 | 97-01 | YTX20H-BS | YTX20-BS | YB18-A | - |
| - | Panther 570 | 02-07 | YTX24HL-BS | - | Y50-N18L-A-CX | - |
| - | Panther 660 | 06-07 | YTX24HL-BS | - | Y50-N18L-A-CX | - |
| - | Powder Extreme, Powder Special | 97-98 | YTX20H-BS | YTX20-BS | YB18-A | - |
| - | Powder Special | 95-97 | YTX20H-BS | YTX20-BS | YB18-A | - |
| - | Prowler | 94 | - | - | YB7-A | 12N7-4A |
| - | Prowler | 90-93 | YTX14AHL-BS | - | YB14L-A2 | - |
| - | Prowler 2-Up | 95 | YTX20H-BS | YTX20-BS | YB18-A | - |
| - | Prowler Special | 91-92 | YTX20H-BS | YTX20-BS | YB18-A | - |
| - | Prowler 550 | -10 | YTX24HL-BS | - | - | - |
| - | Prowler 650 | 06-10 | YTX24HL-BS | - | Y50-N18L-A-CX | - |
| - | Prowler 700 | -10 | YTX24HL-BS | - | - | - |
| - | Puma | 94-96 | YTX14AH-BS | - | YB14-A2 | - |
| - | Sabercat 500 | 04-06 | YTX20H-BS | YTX20-BS | YB18-A | - |
| - | Sabercat 600, 700 | 04-06 | YTX24HL-BS | - | Y50-N18L-A-CX | - |
| - | Super Jag | 89-92 | YTX14AHL-BS | - | YB14L-A2 | - |

World number one for motorcycle batteries

| CC | Model | Year | High Performance Maintenance Free | Maintenance Free VRLA | YuMicron | Conventional |
|-----------------------------|-----------------------------|-------|-----------------------------------|-----------------------|---------------|--------------|
| ARCTIC CAT continued | | | | | | |
| - | Super Jag | 87-88 | - | - | YB16L-B | - |
| - | T500, T570 | -09 | - | - | YB18-A | - |
| - | T660 Touring | 04-06 | YTX24HL-BS | - | Y50-N18L-A-CX | - |
| - | T660 Turbo | 04-07 | YTX24HL-BS | - | - | - |
| - | T660 Turbo Touring | 04-07 | YTX24HL-BS | - | - | - |
| - | Thundercat | 97-02 | YTX20H-BS | YTX20-BS | YB18-A | - |
| - | Wildcat (EFI) | 95-96 | - | - | YB7-A | 12N7-4A |
| - | Wildcat (EFI) | 93 | - | - | YB16L-B | - |
| - | Wildcat MC | 94 | - | - | YB7-A | 12N7-4A |
| - | Wildcat Touring | 95-96 | - | - | YB7-A | 12N7-4A |
| - | Z | 98-01 | YTX14AH-BS | - | YB14-A2 | - |
| - | Z 370, 440 | 02-07 | YTX14AH-BS | - | YB14-A2 | - |
| - | Z 570 | 02-08 | YTX24HL-BS | - | Y50-N18L-A-CX | - |
| - | ZL 500 | 02 | YTX20H-BS | YTX20-BS | YB18-A | - |
| - | ZL 550, 600 | 02-03 | YTX20H-BS | YTX20-BS | YB18-A | - |
| - | ZL 800 | 02-03 | YTX24HL-BS | - | Y50-N18L-A-CX | - |
| - | ZR (EFI) | 95-96 | - | - | YB7-A | 12N7-4A |
| - | ZR 500, 600 | 01-02 | YTX20H-BS | YTX20-BS | YB18-A | - |
| - | ZR 800 | 02-03 | YTX24HL-BS | - | Y50-N18L-A-CX | - |
| - | ZR 900 | 03-06 | YTX24HL-BS | - | Y50-N18L-A-CX | - |
| - | ZRT | 97-02 | YTX20H-BS | YTX20-BS | YB18-A | - |
| BOMBARDIER | | | | | | |
| - | See BRP - SKI-DOO | - | - | - | - | - |
| BRP – SKI-DOO | | | | | | |
| - | All 4-stroke | 03 | YTX24HL-BS | - | - | - |
| - | All Models | - | YTX24HL-BS | - | Y50-N18L-A-CX | Y50-N18L-A |
| - | CK3 Types | 99-03 | YTX24HL-BS | - | Y50-N18L-A-CX | Y50-N18L-A |
| - | Elite | 04-06 | YIX30L | - | - | - |
| - | ZX Types | 99-01 | - | YTX15L-BS | - | - |
| - | ZX Types | 02-03 | YTX20HL-BS | YTX20L-BS | - | - |
| 300 | Skandic | -10 | YTX20HL (WC) | YTX20L (WC) | - | - |
| 550 | Expedition, Skandic, Tundra | 05-16 | YTX20HL (WC) | YTX20L (WC) | - | - |
| 550 | Grand Touring, Renegade | -14 | YTX20HL (WC) | YTX20L-BS | - | - |
| 550 | GSX, GTX, MX Z | 07-14 | YTX20HL (WC) | YTX20L (WC) | - | - |
| 600 | Expedition, Skandic, Summit | 06-16 | YTX20HL (WC) | YTX20L (WC) | - | - |
| 600 | Expedition SE, Skandic ACE | 15-16 | GYZ32HL | - | - | - |
| 600 | Grand Touring, Renegade | 04-16 | YTX20HL (WC) | YTX20L (WC) | - | - |
| 600 | GSX, Tundra, MX Z | 04-16 | YTX20HL (WC) | YTX20L (WC) | - | - |
| 800 | Expedition | 07-16 | YTX20HL (WC) | YTX20L (WC) | - | - |
| 800 | Renegade, Summit, Free Ride | 04-13 | YTX20HL (WC) | YTX20L (WC) | - | - |
| 800 | GSX, MX Z | 04-13 | YTX20HL (WC) | YTX20L (WC) | - | - |
| 900 | Renegade MX Z, Expedition | 14-16 | YTX20HL (WC) | YTX20L (WC) | - | - |
| 1000 | Expedition, Legend, Skandic | 03-06 | YTX24HL (WC) | - | - | - |
| 1200 | Expedition SE | 15-16 | GYZ32HL | - | - | - |
| 1200 | Grand Touring, Expedition | 10-13 | YTX20HL (WC) | - | - | - |
| 1200 | Renegade, GSX, MX Z | 09-13 | YTX20HL (WC) | - | - | - |
| KAWASAKI | | | | | | |
| - | All Models | All | YTX24HL-BS | - | Y50-N18L-A-CX | Y50-N18L-A |

| CC | Model  | Year | High Performance Maintenance Free | Maintenance Free VRLA | YuMicron | Conventional |
|----------------|---|-------|-----------------------------------|-----------------------|---------------|--------------|
| POLARIS | | | | | | |
| - | All EFI (RXL, 500 EFI) | 93-97 | - | - | YB9A-A | - |
| - | All Electric Start Kits | 85-93 | YTX24HL-BS | - | Y50-N18L-A-CX | Y50-N18L-A |
| - | All Electric Start Kits | 94-05 | YTX14AH-BS | - | YB14A-A2 | - |
| - | All Other Models | 92-05 | YTX14AH-BS | - | YB14A-A2 | - |
| - | Indy, Indy Trail | 84-91 | YTX24HL-BS | - | Y50-N18L-A-CX | Y50-N18L-A |
| - | Sprint (Electric-Starter) | 86-90 | - | - | Y60-N24-A | - |
| 544 | Trail, Trail Touring | -10 | YTX14AH-BS | - | YB14A-A2 | - |
| 550 | IQ, LXT, Shift | -13 | YTX20HL-BS | - | - | - |
| - | Rush, IQ, Shift, Switchback, RMK | 09-12 | YTX20HL-BS | - | - | - |
| 600 | Wide Track | 10-12 | YIX30L | - | - | - |
| 600 | IQ Touring | -08 | YTX14AH-BS | - | - | - |
| 600 | IQ, Shift, Switchback, RMK | 09-11 | YTX20HL-BS | - | - | - |
| 600 | Shift, Switchback, RMK | 09-10 | YTX20HL-BS | YTX20L-BS | - | - |
| 600 | Rush | 10-13 | YTX20CH-BS | - | - | - |
| 600 | Switchback, RMK | 11-13 | YTX20CH-BS | - | - | - |
| 600 | Widetrack | 10-16 | YIX30L | - | - | - |
| 750 | FS/FST, Widetrack | 06-10 | YTX20HL-BS | YTX20L-BS | - | - |
| 750 | FS Wide Track | 10-13 | YIX30L | - | - | - |
| 750 | Turbo Switchback, Turbo Dragon | 06-10 | YTX20HL-BS | YTX20L-BS | - | - |
| 750 | Turbo LX, IQ | 08-12 | YTX20HL-BS | YTX20L-BS | - | - |
| YAMAHA | | | | | | |
| 80 | SV80E Sno-Scoot | 88-90 | - | - | YB7L-B | 12N7-3B |
| 125 | SV125E Sno-Sport | 90-91 | YTX14AHL-BS | - | YB14L-A2 | 12N14-3A |
| 300 | CF300 Inviter | 86-90 | - | - | YB16AL-A2 | - |
| 340 | CS340 Ovation Deluxe/LE | 89-98 | YTX14AHL-BS | - | YB14L-A2 | 12N14-3A |
| 340 | EC340 Excel III | 81-88 | YTX14AHL-BS | - | YB14L-A2 | 12N14-3A |
| 340 | ET340E Enticer | 79 | YTX24HL-BS | - | Y50-N18L-A-CX | Y50-N18L-A |
| 340 | ET340E Enticer | 80 | YTX14AHL-BS | - | YB14L-A2 | 12N14-3A |
| 480 | PZ480E Phazer Deluxe | 84-89 | YTX14AHL-BS | - | YB14L-A2 | 12N14-3A |
| 480 | PZ480E Phazer II LE, SS | 90-98 | YTX14AHL-BS | - | YB14L-A2 | 12N14-3A |
| 480 | VT480 Venture GT | 92-93 | YTX14AHL-BS | - | YB14L-A2 | 12N14-3A |
| 480 | VT480 Venture XL | 91-97 | YTX14AHL-BS | - | YB14L-A2 | 12N14-3A |
| 480 | VT480TR Venture TR Electric | 98 | YTX14AHL-BS | - | YB14L-A2 | 12N14-3A |
| 500 | Phazer | -16 | YTX14H-BS | YTX14-BS | - | - |
| 500 | Venture Lite | -13 | YTX14H-BS | YTX14-BS | - | - |
| 500 | PZ500DX Phazer 500 Deluxe | 01 | - | - | YB16AL-A2 | - |
| 500 | PZ50, GT, MP, MT, RT, VT | 09- | YTX14AH-BS | YTX14-BS | - | - |
| 500 | VT500 Venture 500 | 97-01 | - | - | YB16AL-A2 | - |
| 500 | VT500 Venture 500 XL | 99-00 | - | - | YB16AL-A2 | - |
| 500 | VX500E Vmax | 94-01 | - | - | YB16AL-A2 | - |
| 540 | EC540 Excel | 79-80 | YTX24HL-BS | - | Y50-N18L-A-CX | Y50-N18L-A |
| 540 | VK540E, II, III | 89-03 | - | - | YB16AL-A2 | - |
| 540 | XL540 XLV | 85-90 | - | - | YB16AL-A2 | - |
| 570 | EX570E Exciter | 88-90 | - | - | YB16AL-A2 | - |
| 570 | EX570E Exciter II LE | 91-93 | - | - | YB16AL-A2 | - |
| 600 | VT600 Venture 600 | 97-98 | - | - | YB16AL-A2 | - |
| 600 | VT600 Venture 600 | 99-06 | YTX24HL-BS | - | Y50-N18L-A-CX | Y50-N18L-A |
| 600 | VX600DX Vmax 600 Deluxe | 99-01 | YTX24HL-BS | - | Y50-N18L-A-CX | Y50-N18L-A |
| 600 | VX600E/DX Vmax 600 LE/DX | 94-96 | - | - | YB16AL-A2 | - |
| 600 | VX600ER Vmax 600 ER | 02-03 | YTX24HL-BS | - | Y50-N18L-A-CX | Y50-N18L-A |
| 600 | VX600XTC Vmax 600 XTC | 97-98 | - | - | YB16AL-A2 | - |
| 700 | SXV700ER SXViper ER | 02-05 | YTX24HL-BS | - | Y50-N18L-A-CX | Y50-N18L-A |

Can't find your vehicle listed?
Visit www.yuasa.com for our latest application data

| CC | Model | Year | High Performance Maintenance Free | Maintenance Free VRLA | YuMicron | Conventional |
|-------------------------|-------------------------------|-------|-----------------------------------|-----------------------|---------------|--------------|
| YAMAHA continued | | | | | | |
| 700 | VT700 Venture 700 | 98-04 | YTX24HL-BS | - | Y50-N18L-A-CX | Y50-N18L-A |
| 700 | VX700DX Vmax 700 Deluxe | 99-00 | YTX24HL-BS | - | Y50-N18L-A-CX | Y50-N18L-A |
| 700 | VX700ER Vmax 700 ER | 01-02 | YTX24HL-BS | - | Y50-N18L-A-CX | Y50-N18L-A |
| 700 | VX700XTCD Vmax 700 XTC Deluxe | 98 | YTX24HL-BS | - | Y50-N18L-A-CX | Y50-N18L-A |
| 500 | Phazer | -12 | YTX14H-BS | YTX14-BS | - | - |
| 500 | Venture Lite | -12 | YTX14H-BS | YTX14-BS | - | - |
| 973 | Vector | -09 | YTX20HL-BS | YTX20L-BS | - | - |
| 973 | RS Venture | 16 | YTX20HL-BS | YTX20L-BS | - | - |
| 973 | RS Viking Professional | 09-13 | YTX20HL-BS | YTX20L-BS | - | - |
| 973 | RS90GT, LTGT | 09- | YTX20HL-BS | YTX20L-BS | - | - |
| 1000 | Apex | 06-16 | YTX14H-BS | YTX14-BS | - | - |
| 1000 | RS1000S, GT, RS | - | YTX20HL-BS | YTX20L-BS | - | - |
| 1000 | RX1000R RX (All Models) | 03-05 | YTX20HL-BS | - | - | - |
| 1000 | RX10GT | 09- | YTX14H-BS | YTX14-BS | - | - |
| 1000 | RX10 LTGT, MT, MTR, RTR | 09- | YTX14H-BS | YTX14-BS | - | - |
| 1049 | FX10RTRS, XT | 09- | YTX20HL-BS | YTX20L-BS | - | - |
| 1049 | FX Nitro | -13 | YTX20HL-BS | YTX20L-BS | - | - |
| 1049 | RS Venture | -13 | YTX20HL-BS | YTX20L-BS | - | - |
| 1049 | RS Vector | -16 | YTX20HL-BS | YTX20L-BS | - | - |
| 1049 | RS Viking professional | 09-12 | YTX20HL-BS | YTX20L-BS | - | - |
| 1049 | RST90GT | 09- | YTX20HL-BS | YTX20L-BS | - | - |
| 1049 | RST90TF | 09- | YTX20HL-BS | YTX20L-BS | - | - |
| 1049 | SR VIPER L/M/R/S/X | 14-16 | YTX20H-BS | - | - | - |
| 1049 | VK Professional II | -16 | YTX20HL-BS | YTX20L-BS | - | - |

Utility

ARCTIC CAT

| | | | | | | |
|------|-------------------------|-------|------------|---|---------------|---|
| 550 | Prowler 550 | -09 | YTX24HL-BS | - | - | - |
| 550 | Prowler 550 | 10-15 | YIX30L-BS | - | YB30L-B | - |
| 650 | Prowler 650 | 06-09 | YTX24HL-BS | - | Y50-N18L-A-CX | - |
| 700 | Prowler 700 | -09 | YTX24HL-BS | - | - | - |
| 700 | Prowler 700 | 10-16 | YIX30L-BS | - | YB30L-B | - |
| 700 | Wildcat Sport, Trail | -16 | YIX30L-BS | - | YB30L-B | - |
| 1000 | Prowler 1000 | -16 | YIX30L-BS | - | YB30L-B | - |
| 1000 | Wildcat 1000, X, 4, LTD | -16 | YIX30L-BS | - | YB30L-B | - |

HONDA

| | | | | | | |
|------|----------------|-------|-----------|----------|---|---|
| 500 | Pioneer 500 | 15-16 | GYZ16H | - | - | - |
| 700 | MUV700 Big Red | 08-13 | YTX14H-BS | YTX14-BS | - | - |
| 700 | Pioneer 700 | 15-16 | YTX14H-BS | YTX14-BS | - | - |
| 1000 | Pioneer 1000 | 16 | GYZ16H | - | - | - |

KAWASAKI

| | | | | | | |
|-----|-------------------------------|-------|---------------|-----------|----------|---|
| 300 | KAF300, Mule 500, 520, 550 | - | YTX14AH-BS | - | YB14A-A2 | - |
| 400 | KAF400, Mule 600, 610 | 05-16 | YTX14AH-BS | - | YB14A-A2 | - |
| 450 | KAF450, Mule 1000 | - | YTX20HL-BS-PW | - | YB16CL-B | - |
| 540 | KAF540, Mule 2010, 2020, 2030 | - | YTX20HL-BS-PW | - | YB16CL-B | - |
| 620 | Advantage Classic | 03-07 | YTX20HL-BS | YTX20L-BS | - | - |
| 620 | KAF620, Mule 2500, 2510, 2520 | - | YTX20HL-BS-PW | - | YB16CL-B | - |
| 620 | KAF620, Mule 3000, 3010, 3020 | - | YTX20HL-BS | YTX20L-BS | - | - |
| 620 | KAF620, Mule 3010 4x4 | - | YTX20HL-BS-PW | - | YB16CL-B | - |
| 620 | KAF620F, Mule 4010 4x4 (CN) | 09-16 | YTX20HL-BS | YTX20L-BS | - | - |

| CC | Model | Year | High Performance Maintenance Free | Maintenance Free VRLA | YuMicron | Conventional |
|---------------------------|---------------------------------------|-------|-----------------------------------|-----------------------|----------|--------------|
| KAWASAKI continued | | | | | | |
| 620 | Mule 4000 | 09-16 | Not available | - | - | - |
| 620 | KAF620F, Mule 4010 4x4 (US) | 09-16 | Not available | - | - | - |
| 620 | Mule 4010 Trans4x4, Diesel, Mule 4000 | 09-16 | Not available | - | - | - |
| 750 | Teryx All Models (CN) | 08-16 | - | KMX14-BS* | - | - |
| 950 | KAF950, Mule 2510, 3010 Diesel | -10 | Not Available | - | - | - |
| KYMCO | | | | | | |
| 450 | UXV450 | 16 | YTX20HL-BS | YTX20L-BS | - | - |
| 500 | UXV500 | 16 | YTX20HL-BS | YTX20L-BS | - | - |
| 700 | UXV700 | 16 | YTX20HL-BS | YTX20L-BS | - | - |
| PIAGGIO | | | | | | |
| - | Ape Mix | 01- | - | - | YB9-B | - |
| - | Ape50 FL | 93 | - | - | YB9-B | - |
| - | Ape50 FL2 | - | - | - | YB9-B | - |
| POLARIS | | | | | | |
| 170 | RZR | -16 | - | YTX12-BS | - | - |
| 400 | Ranger 400 | 11-13 | YTX14AH-BS | - | YB14-B2 | - |
| 425 | Ranger 2x4 | 02-03 | YIX30L | - | YB30L-B | - |
| 500 | Ranger 6x6, 4x4 | 98-04 | YIX30L | - | YB30L-B | - |
| 500 | Ranger 4x4 | 04-10 | - | YIX30L-BS | YB30L-B | - |
| 500 | Ranger 4x4s | 11-13 | YTX14AH-BS | - | YB14-B2 | - |
| 570 | RZR 570 | 12-16 | YTX14AH-BS | - | YB14-B2 | - |
| 570 | RZR 570 EPS | 13-16 | GYZ32HL | - | YB30L-B | - |
| 700 | Ranger 6x6 | 06-10 | YIX30L | - | YB30L-B | - |
| 800 | RZR | 08-14 | YTX20HL-BS | - | - | - |
| 800 | RZR 4, RZR S 800 | 10-14 | YIX30L-BS | - | - | - |
| 800 | Ranger | 10-13 | - | YIX30L-BS | YB30L-B | - |
| 800 | Ranger RZR | 11-13 | YIX30L-BS | - | - | - |
| 900 | RZR | 11-16 | YIX30L-BS | - | - | - |
| SUZUKI | | | | | | |
| 620 | QUV620F | 05 | YTX20HL-BS | YTX20L-BS | - | - |
| YAMAHA | | | | | | |
| - | Rhino | All | Not available | - | - | - |
| 700 | Viking | 14-16 | Not available | - | - | - |
| 700 | Wolverine | 16 | Not available | - | - | - |
| 1000 | YZZ1000R | 16 | Not available | - | - | - |

* Available from Kawasaki Main Dealer only

| CC | Model | Year | High Performance Maintenance Free | Maintenance Free VRLA | YuMicron | Conventional |
|---------------------------|------------------------------------|-------|-----------------------------------|-----------------------|----------|--------------|
| AQA-JET CO. | | | | | | |
| 430 | Aqua-Jet SX1 | 91 | - | - | YB16-B | - |
| 432 | Aqua-Jet Sx1 | 89-90 | - | - | YB16-B | - |
| ARCTIC CAT | | | | | | |
| 640 | Tiger Shark | 97-99 | YTX14AHL-BS | - | YB14L-A2 | - |
| 770 | Tiger Shark | 97-99 | YTX14AHL-BS | - | YB14L-A2 | - |
| - | Tiger Shark (All Models) | 93-01 | - | - | YB16CL-B | - |
| ARCTOCO | | | | | | |
| 650 | Tiger Shark (All Models) | 93-98 | - | - | YB16CL-B | - |
| BOMBARDIER | | | | | | |
| | See BRP - SEA-DOO | - | - | - | - | - |
| BRP – SEA-DOO | | | | | | |
| - | All Models | 88-93 | YTX20HL-BS | YTX20L-BS | YB16L-B | - |
| - | All Other Models | 94-07 | YTX20HL-BS-PW | - | YB16CL-B | - |
| 780 | 3D | -07 | YTX20HL-BS-PW | - | YB16CL-B | - |
| 900 | SPARK | 14-16 | GYZ20HL | - | - | - |
| 1500 | GTI, GTR, GTS, GTX, RXT, RXP, WAKE | 16 | GYZ20HL | - | - | - |
| 1500 | GTI, GTX, GTR RXP, RXT, WAKE | -15 | YIX30L-BS-PW | - | YB30CL-B | - |
| 1500 | GTX 4-Tec, RXP | 03-07 | YIX30L-BS-PW | - | YB30CL-B | - |
| FAZER | | | | | | |
| 430 | All Models | 88-89 | - | - | YB16-B | - |
| HONDA | | | | | | |
| 1235 | AquaTrax F/R-12, F/R-12X | 02-09 | YTX20HL-BS | YTX20L-BS | - | - |
| 1470 | AquaTrax F-15, F-15X | 03-13 | YTX20HL-BS | YTX20L-BS | - | - |
| KAWASAKI (Jet Ski) | | | | | | |
| 300 | JS300 TS, SX | 86-91 | YTX20HL-BS-PW | - | YB16CL-B | - |
| 300 | JS399-A | 87-91 | YTX20HL-BS-PW | - | YB16CL-B | - |
| 400 | JS400 | 76 | YTX20HL-BS | YTX20L-BS | YB16L-B | - |
| 440 | JS440 | 87-92 | YTX20HL-BS-PW | - | YB16CL-B | - |
| 440 | JS440 | 77-86 | YTX20HL-BS | YTX20L-BS | YB16L-B | - |
| 550 | JS550 | 82-85 | YTX20HL-BS | YTX20L-BS | YB16L-B | - |
| 550 | JS550, SX | 86-95 | YTX20HL-BS-PW | - | YB16CL-B | - |
| 650 | JF650 TS | 89-96 | YTX20HL-BS-PW | - | YB16CL-B | - |
| 650 | JF650 X2 | 86-95 | YTX20HL-BS-PW | - | YB16CL-B | - |
| 650 | JL650 SC | 91-95 | YTX20HL-BS-PW | - | YB16CL-B | - |
| 650 | JS650 SX | 87-95 | YTX20HL-BS-PW | - | YB16CL-B | - |
| 650 | MATE | 91 | YTX20HL-BS-PW | - | YB16CL-B | - |
| 650 | SC | - | YTX20HL-BS-PW | - | YB16CL-B | - |
| 750 | JH750 B1-b3 | 93-95 | YTX20HL-BS-PW | - | YB16CL-B | - |
| 750 | JH750 E1,F2,G1,G2 | 95-99 | YTX20HL-BS | YTX20L-BS | - | - |
| 750 | JH750 SS, ST, Xi, XiR | 92-99 | YTX20HL-BS-PW | - | YB16CL-B | - |
| 750 | JH750 ST, Zxi | 95-97 | YTX20HL-BS | YTX20L-BS | - | - |
| 750 | JH750 SX,ZX | 92-95 | YTX20HL-BS-PW | - | YB16CL-B | - |
| 750 | JH750 Xi | 93-99 | YTX20HL-BS-PW | - | YB16CL-B | - |
| 750 | JH750 XiR | 94 | YTX20HL-BS-PW | - | YB16CL-B | - |

| CC | Model  | Year | High Performance Maintenance Free | Maintenance Free VRLA | YuMicron | Conventional |
|-------------------------------------|---|-------|-----------------------------------|-----------------------|-----------|--------------|
| KAWASAKI (Jet Ski) continued | | | | | | |
| 750 | JH750 Zxi | 95-97 | YTX20HL-BS | YTX20L-BS | - | - |
| 750 | JS750 SX, ZX | 92-95 | YTX20HL-BS-PW | - | YB16CL-B | - |
| 750 | JS750 SXi, SXi Pro | 95-02 | YTX20HL-BS | YTX20L-BS | - | - |
| 750 | JT750 STS, STX | 96-98 | YTX20HL-BS | YTX20L-BS | - | - |
| 750 | JT750 XiR, ST, STS | 94-95 | YTX20HL-BS-PW | - | YB16CL-B | - |
| 750 | Super Sport Xi | 93 | YTX20HL-BS-PW | - | YB16CL-B | - |
| 750 | Xi Sport | 99 | YTX20HL-BS-PW | - | YB16CL-B | - |
| 800 | JS800 SX-R | 03-13 | YTX20HL-BS | YTX20L-BS | - | - |
| 900 | JH900 ZXi | 95-97 | YTX20HL-BS | YTX20L-BS | - | - |
| 900 | JT900 STS, STX | 97-05 | YTX20HL-BS | YTX20L-BS | - | - |
| 1100 | JH1100 ZXi | 96-03 | YTX20HL-BS | YTX20L-BS | - | - |
| 1100 | JH1100-B Ultra 130 | 01-04 | YTX20HL-BS | YTX20L-BS | - | - |
| 1100 | JT1100 STX | 97-03 | YTX20HL-BS | YTX20L-BS | - | - |
| 1100 | JT1100 ZXi | 96-03 | YTX20HL-BS | YTX20L-BS | - | - |
| 1200 | JH1200-A, B Ultra 150 | 99-05 | YTX20HL-BS | YTX20L-BS | - | - |
| 1200 | JT1200-A-B, C, STX-R, STX-12F | 02-07 | YTX20HL-BS | YTX20L-BS | - | - |
| 1500 | JT1500-A, STX, STX-15F | 04-13 | YTX20HL-BS | YTX20L-BS | - | - |
| 1500 | JT1500B, C, 250X, Ultra LX, | 07-16 | YTX20HL-BS | YTX20L-BS | - | - |
| KYMCO | | | | | | |
| 400 | MAXXER 400 | 11- | - | YTX20L-BS | - | - |
| 400 | MXU 400 | 11- | - | YTX12-BS | - | - |
| 500 | UXV 500 | 11- | - | YTX20L-BS | - | - |
| POLARIS | | | | | | |
| - | All Models | All | YTX20HL-BS-PW | - | YB16CL-B | - |
| S.O.S. MARINE MFG | | | | | | |
| - | All Models | All | YTX20H-BS | YTX20-BS | YB16-B-CX | YB16-B |
| ULTRANAUTICS | | | | | | |
| 800 | All Models | 87-92 | - | - | 53030 | - |
| 800 | Wet Bike | 87-92 | - | - | 53030 | - |
| 800 | Wet Bike | 85-86 | - | - | - | YHD-12 |
| - | Jet Star1250 (Boat) | 88-90 | - | - | 53030 | - |
| - | Jet Star1260 (Boat) | 91 | - | - | 53030 | - |
| WET JET INTERNATIONAL | | | | | | |
| - | All Models | All | YTX20H-BS | YTX20-BS | YB16-B-CX | YB16-B |
| YAMAHA | | | | | | |
| All | All Wave Runner Models | 87-08 | YTX20HL-BS-PW | - | - | - |
| 700 | Superjet | 09-16 | YTX20HL-BS-PW | - | YB16CL-B | - |
| 1100 | VX, V1 | 09-16 | YTX20HL-BS-PW | - | YB16CL-B | - |
| 1800 | FX, FZR, FZS, VXS, VXR | 09-16 | YTX20HL-BS-PW | - | YB16CL-B | - |

Can't find your vehicle listed?
Visit www.yuasa.com for our latest application data

| CC | Model |  | Year | High Performance Maintenance Free | Maintenance Free VRLA | YuMicron | Conventional |
|----------------------------------|----------------------|---|-------|-----------------------------------|-----------------------|----------|--------------|
| ALLIS-CHALMERS | | | | | | | |
| - | 405 | - | - | - | - | YB9-B | 12N9-4B-1 |
| - | 508 | - | - | - | - | YB9-B | 12N9-4B-1 |
| ARCTIC CAT | | | | | | | |
| - | 1028 | - | - | - | - | YB12A-A | 12N12A-4A-1 |
| - | 1330 | - | - | - | - | YB12A-A | 12N12A-4A-1 |
| - | 1330 | - | - | - | - | YB14A-A2 | - |
| - | 1332 | - | - | - | - | YB12A-A | 12N12A-4A-1 |
| - | 1332 | - | - | - | - | YB14A-A2 | - |
| - | 8028 | - | - | - | - | YB14A-A2 | - |
| - | 8530 | - | - | - | - | YB14A-A2 | - |
| - | 901000 Series | - | - | - | - | YB12A-A | 12N12A-4A-1 |
| - | 912000 Series | - | - | - | - | YB12A-A | 12N12A-4A-1 |
| - | 91400 Electric-start | - | 76-95 | - | - | YB12A-A | 12N12A-4A-1 |
| - | 925000 Series | - | - | - | - | YB12A-A | 12N12A-4A-1 |
| - | 927000 Series | - | - | - | - | YB12A-A | 12N12A-4A-1 |
| - | RM 1328E | - | - | - | - | YB14-A2 | - |
| - | RM 1330 | - | - | - | - | YB14-A2 | - |
| - | RM 1332E | - | - | - | - | YB14-A2 | - |
| - | RM 8028 | - | - | - | - | YB14-A2 | - |
| - | RM 828E | - | - | - | - | YB14-A2 | - |
| - | RM 8530 | - | - | - | - | YB14-A2 | - |
| ATLAS TOOL & MFG. CO. | | | | | | | |
| - | ER2600 | - | - | - | - | - | 12N9-3A |
| - | ER2650 | - | - | - | - | - | 12N9-3A |
| - | ER2680 | - | - | - | - | - | 12N9-3A |
| - | ER3280 | - | - | - | - | - | 12N9-3A |
| BOLENS | | | | | | | |
| - | G8 | - | - | - | - | 53030 | - |
| - | G11LT | - | - | - | - | 53030 | - |
| - | Husky 728 | - | - | - | - | YB9-B | 12N9-4B-1 |
| - | Husky 770 | - | - | - | - | YB9-B | 12N9-4B-1 |
| - | Husky 829 | - | - | - | - | YB9-B | 12N9-4B-1 |
| CARTER BROTHERS | | | | | | | |
| - | EZ-502 / EZ-502C | - | - | - | - | YB12A-A | 12N12A-4A-1 |
| - | EZ-702 / EZ-702C | - | - | - | - | YB12A-A | 12N12A-4A-1 |
| CASE, J.I. | | | | | | | |
| - | M-80 | - | - | - | - | YB12A-A | 12N12A-4A-1 |
| CUB CADET (INT.HARVESTER) | | | | | | | |
| - | 1106 | - | - | - | - | YB14L-A2 | 12N14-3A |
| - | 1136 | - | - | - | - | YB14L-A2 | 12N14-3A |
| - | 182 | - | - | - | - | YB14L-A2 | 12N14-3A |
| - | 282 | - | - | - | - | YB14L-A2 | 12N14-3A |
| - | 382 | - | - | - | - | YB14L-A2 | 12N14-3A |
| - | 382H | - | - | - | - | YB14L-A2 | 12N14-3A |
| - | 514 | - | - | - | - | YB14L-A2 | 12N14-3A |

| CC | Model | Year | High Performance Maintenance Free | Maintenance Free VRLA | YuMicron | Conventional |
|--|-------------|-------|-----------------------------------|-----------------------|----------|--------------|
| CUB CADET (INT.HARVESTER) continued | | | | | | |
| - | 518 | - | - | - | YB14L-A2 | 12N14-3A |
| - | 583 | - | - | - | YB14L-A2 | 12N14-3A |
| - | 800 | - | - | - | YB14L-A2 | 12N14-3A |
| - | 804 | - | - | - | YB14L-A2 | 12N14-3A |
| - | 830 | - | - | - | YB14L-A2 | 12N14-3A |
| DEUTZ (ALLIS-CHALMERS) | | | | | | |
| - | 405 | - | - | - | YB9-B | 12N9-4B-1 |
| - | 508 | - | - | - | YB9-B | 12N9-4B-1 |
| GARDEN WAY | | | | | | |
| - | Pony | 96- | - | - | YB9-B | 12N9-4B-1 |
| GENERAL POWER | | | | | | |
| - | 3-725 E7-E9 | - | - | - | YB12A-A | 12N12A-4A-1 |
| - | WES725 | - | - | - | YB12A-A | 12N12A-4A-1 |
| - | WES725 FS | - | - | - | YB12A-A | 12N12A-4A-1 |
| GIANT-VAC | | | | | | |
| - | 1601-CEHW | - | - | - | YB14L-A2 | 12N14-3A |
| - | 1901-CEHW | 99-15 | - | - | YB14L-A2 | 12N14-3A |
| GRAVELY | | | | | | |
| - | Pro 60 | - | - | - | YB16L-B | - |
| HOMELITE / JACOBSEN | | | | | | |
| - | RE1030E | - | - | - | YB9-B | 12N9-4B-1 |
| - | RE1230E | - | - | - | YB9-B | 12N9-4B-1 |
| - | RE830E | - | - | - | YB9-B | 12N9-4B-1 |
| - | RE-8E | - | - | - | YB9-B | 12N9-4B-1 |
| HUFFMAN (HUFFY) | | | | | | |
| - | H-270 | - | - | - | YB12A-A | 12N12A-4A-1 |
| - | H-360 | - | - | - | YB12A-A | 12N12A-4A-1 |
| HULL INDUSTRIES | | | | | | |
| - | TC30ER | - | - | - | YB16-B | - |
| INGERSOL EQUIPMENT | | | | | | |
| - | 80XC | 84-93 | - | - | YB12A-A | 12N12A-4A-1 |
| - | 80XE | 84-93 | - | - | YB12A-A | 12N12A-4A-1 |
| - | 80XI | - | - | - | YB12A-A | 12N12A-4A-1 |
| - | 80XM | 84-93 | - | - | YB12A-A | 12N12A-4A-1 |
| - | 810 | - | - | - | YB12A-A | 12N12A-4A-1 |
| JACOBSEN MFG. CO. | | | | | | |
| - | 42602 | - | - | - | YB9-B | 12N9-4B-1 |
| - | 42642 | - | - | - | YB9-B | 12N9-4B-1 |
| - | 43020 | - | - | - | YB9-B | 12N9-4B-1 |
| - | 43032 | - | - | - | YB9-B | 12N9-4B-1 |

| CC | Model |  | Year | High Performance Maintenance Free | Maintenance Free VRLA | YuMicron | Conventional |
|------------------------------------|---------------------|---|------|-----------------------------------|-----------------------|----------|--------------|
| JACOBSEN MFG. CO. continued | | | | | | | |
| - | 43037 | | - | - | - | YB9-B | 12N9-4B-1 |
| - | 43043 | | - | - | - | YB9-B | 12N9-4B-1 |
| - | Javelin MK11 | | - | - | - | YB9-B | 12N9-4B-1 |
| - | RE-8E | | - | - | - | YB9-B | 12N9-4B-1 |
| KAWASAKI | | | | | | | |
| - | Mule 550 | | - | - | - | YB14-A2 | - |
| KLIPPO | | | | | | | |
| - | 11E | | - | - | - | 53030 | - |
| KUBOTA | | | | | | | |
| - | Mule 2500 | | - | - | YTX20L-BS | YB16L-B | - |
| LAWN BOY | | | | | | | |
| - | 333 | | - | - | - | - | 12N9-3A |
| - | 335 | | - | - | - | - | 12N9-3A |
| - | 5802 | | - | - | - | - | 12N9-3A |
| - | 5803 | | - | - | - | - | 12N9-3A |
| - | 7258E | | - | - | - | - | 12N9-3A |
| - | 7259E | | - | - | - | - | 12N9-3A |
| - | 7260E | | - | - | - | - | 12N9-3A |
| - | 8227E | | - | - | - | - | 12N9-3A |
| - | 8228E | | - | - | - | - | 12N9-3A |
| - | 8229E | | - | - | - | - | 12N9-3A |
| - | 8229EA | | - | - | - | - | 12N9-3A |
| - | 8233E | | - | - | - | - | 12N9-3A |
| MONTGOMERY WARD | | | | | | | |
| - | 99 and under series | | - | - | - | YB9-B | 12N9-4B-1 |
| MTD / YARDMAN | | | | | | | |
| - | 300 Series | | 81- | - | - | YB14L-A2 | 12N14-3A |
| - | 385 | | 81- | - | - | YB14L-A2 | 12N14-3A |
| - | 395 | | 81- | - | - | YB14L-A2 | 12N14-3A |
| - | 400 Series | | 81- | - | - | YB14L-A2 | 12N14-3A |
| - | 410 | | 81- | - | - | YB14L-A2 | 12N14-3A |
| - | 412 | | 81- | - | - | YB14L-A2 | 12N14-3A |
| - | 435 | | 81- | - | - | YB14L-A2 | 12N14-3A |
| - | 445 | | 81- | - | - | YB14L-A2 | 12N14-3A |
| - | 465 | | 81- | - | - | YB14L-A2 | 12N14-3A |
| - | 466 | | 81- | - | - | YB14L-A2 | 12N14-3A |
| - | 485 | | 81- | - | - | YB14L-A2 | 12N14-3A |
| - | 489 | | 81- | - | - | YB14L-A2 | 12N14-3A |
| - | 495 | | 81- | - | - | YB14L-A2 | 12N14-3A |
| - | 497 | | 81- | - | - | YB14L-A2 | 12N14-3A |
| - | 500 Series | | 81- | - | - | YB14L-A2 | 12N14-3A |
| - | 525 | | 81- | - | - | YB14L-A2 | 12N14-3A |
| - | 526 | | 81- | - | - | YB14L-A2 | 12N14-3A |
| - | 542 | | 81- | - | - | YB14L-A2 | 12N14-3A |
| - | 600 | | 81- | - | - | YB14L-A2 | 12N14-3A |

| CC | Model | Year | High Performance Maintenance Free | Maintenance Free VRLA | YuMicron | Conventional |
|--------------------------------|----------------------------|------|-----------------------------------|-----------------------|------------|--------------|
| MTD / YARDMAN continued | | | | | | |
| - | 600 Series | 81- | - | - | YB14L-A2 | 12N14-3A |
| - | 632 | 81- | - | - | YB14L-A2 | 12N14-3A |
| - | 660 | 81- | - | - | YB14L-A2 | 12N14-3A |
| - | 672 | 81- | - | - | YB14L-A2 | 12N14-3A |
| - | 682 | 81- | - | - | YB14L-A2 | 12N14-3A |
| - | 698 | 81- | - | - | YB14L-A2 | 12N14-3A |
| - | 700-800 Series (Twin Cyl.) | - | - | - | Y50-N18L-A | - |
| - | 760 | - | - | - | YB14L-A2 | 12N14-3A |
| - | 775 | - | - | - | YB14L-A2 | 12N14-3A |
| - | 795 | - | - | - | YB14L-A2 | 12N14-3A |
| - | 796 | - | - | - | YB14L-A2 | 12N14-3A |
| MURRAY | | | | | | |
| - | 2523 | - | - | - | YB14L-A2 | 12N14-3A |
| - | 3033 | - | - | - | YB14L-A2 | 12N14-3A |
| - | 3035 | - | - | - | YB14L-A2 | 12N14-3A |
| - | 6-3050 2x4 | - | - | - | YB14L-A2 | 12N14-3A |
| - | 6-30502 | - | - | - | YB14L-A2 | 12N14-3A |
| - | 6-3070 2x4 | - | - | - | YB14L-A2 | 12N14-3A |
| - | 6-30702 | - | - | - | YB14L-A2 | 12N14-3A |
| - | 7-30502 | - | - | - | YB14L-A2 | 12N14-3A |
| - | All Rear Engine Mowers | - | - | - | YB14L-A2 | 12N14-3A |
| NOMA | | | | | | |
| - | 320805 | - | - | - | YB14L-A2 | 12N14-3A |
| - | 321050-321054 | - | - | - | YB14L-A2 | 12N14-3A |
| - | 328000-328018 | - | - | - | YB14L-A2 | 12N14-3A |
| - | 360100 | - | - | - | YB14L-A2 | 12N14-3A |
| - | 360101 | - | - | - | YB14L-A2 | 12N14-3A |
| ROPER | | | | | | |
| - | 96444 | - | - | - | YB9-B | 12N9-4B-1 |
| - | 96927 | - | - | - | YB9-B | 12N9-4B-1 |
| - | 96941 | - | - | - | YB9-B | 12N9-4B-1 |
| - | K522 | - | - | - | YB9-B | 12N9-4B-1 |
| - | K832 | - | - | - | YB9-B | 12N9-4B-1 |
| - | K852 | - | - | - | YB9-B | 12N9-4B-1 |
| - | K9224AR | - | - | - | YB14L-A2 | 12N14-3A |
| - | K922PRA | - | - | - | YB14L-A2 | 12N14-3A |
| - | K9324AAR | - | - | - | YB14L-A2 | 12N14-3A |
| - | K932PRA | - | - | - | YB14L-A2 | 12N14-3A |
| - | L722 | - | - | - | YB9-B | 12N9-4B-1 |
| - | L72256R | - | - | - | YB9-B | 12N9-4B-1 |
| - | L8000AT | - | - | - | YB14L-A2 | 12N14-3A |
| SEARS | | | | | | |
| - | 131.96927 - 131.969310 | - | - | - | - | 12N9-3A |
| - | 131.96941 - 131.96970 | - | - | - | - | 12N9-3A |
| - | 136 | - | - | YTX20L-BS | YB16L-B | - |
| - | 137 | - | - | YTX20L-BS | YB16L-B | - |
| - | 140 | - | - | YTX20L-BS | YB16L-B | - |
| - | 141 | - | - | YTX20L-BS | YB16L-B | - |

Can't find your vehicle listed?
 Visit www.yuasa.com for our latest application data

| CC | Model | Year | High Performance Maintenance Free | Maintenance Free VRLA | YuMicron | Conventional |
|------------------------|--------------------------|------|-----------------------------------|-----------------------|----------|--------------|
| SEARS continued | | | | | | |
| - | 142 | - | - | YTX20L-BS | YB16L-B | - |
| - | 255113 | - | - | - | YB9-B | 12N9-4B-1 |
| - | 255120 | - | - | - | YB9-B | 12N9-4B-1 |
| - | 255212 | - | - | - | YB9-B | 12N9-4B-1 |
| - | 255221 | - | - | - | YB9-B | 12N9-4B-1 |
| - | 255223 | - | - | - | YB9-B | 12N9-4B-1 |
| - | 255232 | - | - | - | YB9-B | 12N9-4B-1 |
| - | 255240 | - | - | - | YB9-B | 12N9-4B-1 |
| - | 255250 | - | - | - | YB9-B | 12N9-4B-1 |
| - | 502.256050 - 502.256051 | - | - | - | YB14L-A2 | 12N14-3A |
| - | 502.256060 - 502.256063 | - | - | - | YB14L-A2 | 12N14-3A |
| - | 502.256070 - 502.256071 | - | - | - | YB14L-A2 | 12N14-3A |
| - | 502.256080 - 502.256081 | - | - | - | YB14L-A2 | 12N14-3A |
| - | 502.256120 - 502.256126 | - | - | - | YB14L-A2 | 12N14-3A |
| - | 502.256130 - 502.256132 | - | - | - | YB14L-A2 | 12N14-3A |
| - | 502.256134 - 502.256136A | - | - | - | YB14L-A2 | 12N14-3A |
| - | 502.256135 - 502.256136 | - | - | YTX20L-BS | YB16L-B | - |
| - | 502.256137 - 502.256140 | - | - | YTX20L-BS | YB16L-B | - |
| - | 502.256138 | - | - | - | YB14L-A2 | 12N14-3A |
| - | 502.256141 - 502.256142 | - | - | YTX20L-BS | YB16L-B | - |
| - | 536.250820 - 536.250823 | - | - | - | - | 12N9-3A |
| - | 536.250870 - 536.250920 | - | - | - | - | 12N9-3A |
| - | 536.250922 - 536.255110 | - | - | - | - | 12N9-3A |
| - | 536.255112 - 536.255113 | - | - | - | - | 12N9-3A |
| - | 536.255212 - 536.255220 | - | - | - | - | 12N9-3A |
| - | 536.255221 - 536.255230 | - | - | - | - | 12N9-3A |
| - | 536.255232 - 536.255240 | - | - | - | - | 12N9-3A |
| - | 536.255250 - 536.657020 | - | - | - | - | 12N9-3A |
| - | 536.657040 - 536.657060 | - | - | - | - | 12N9-3A |
| - | 536.657080 - 536.658080 | - | - | - | - | 12N9-3A |
| - | 536.963100 - | - | - | - | - | 12N9-3A |
| - | 8-2525 | - | - | - | YB14L-A2 | 12N14-3A |
| - | 8-3035 | - | - | - | YB14L-A2 | 12N14-3A |
| - | 881400 | - | - | - | YB9-B | 12N9-4B-1 |
| - | 88170 | - | - | - | YB9-B | 12N9-4B-1 |
| - | 917.255121 - 917.259180 | - | - | - | - | 12N9-3A |
| - | 917.255260 - 917.255270 | - | - | - | YB14L-A2 | 12N14-3A |
| - | 917.255273 - 917.255330 | - | - | - | YB14L-A2 | 12N14-3A |
| - | 917.25534 | - | - | - | YB14L-A2 | 12N14-3A |
| - | 917.25932 | - | - | - | - | 12N9-3A |
| - | 917-250740 - 917.255120 | - | - | - | - | 12N9-3A |
| - | K8327AR | - | - | - | YB9-B | 12N9-4B-1 |
| SIMPLICITY | | | | | | |
| - | 3008 | - | - | - | YB9-B | 12N9-4B-1 |
| - | 3008-3 | - | - | - | YB9-B | 12N9-4B-1 |
| - | 99075 | - | - | - | YB9-B | 12N9-4B-1 |
| SNAPPER | | | | | | |
| - | 21401PS | - | - | YTX4L-BS | - | - |
| - | 21401S | - | - | YTX4L-BS | - | - |
| - | 214X1PS | - | - | YTX4L-BS | - | - |

| CC | Model | Year | High Performance Maintenance Free | Maintenance Free VRLA | YuMicron | Conventional |
|--------------------------------|-------------------|------|-----------------------------------|-----------------------|------------|--------------|
| SWISHER | | | | | | |
| - | 18Hp/32 | - | - | - | YB12A-A | 12N12A-4A-1 |
| - | Ride King | - | - | - | YB12A-A | 12N12A-4A-1 |
| - | Rough Cut 50 in. | - | - | - | YB14A-A2 | - |
| TROY BUILT | | | | | | |
| - | Pony Rototiller | - | - | - | YB9-B | 12N9-4B-1 |
| - | Pony Rototiller | 96 | - | - | YB12A-A | 12N12A-4A-1 |
| WESTERN INT. (DYNAMARK) | | | | | | |
| - | 320000 Series | - | - | - | YB14L-A2 | 12N14-3A |
| - | 360000 Series | - | - | - | YB14L-A2 | 12N14-3A |
| - | 421101 | - | - | - | YB14L-A2 | 12N14-3A |
| - | 456301 | - | - | - | YB14L-A2 | 12N14-3A |
| WHEEL HORSE | | | | | | |
| - | 108-3 | - | - | - | YB14L-A2 | 12N14-3A |
| - | 108-5 | - | - | - | YB14L-A2 | 12N14-3A |
| - | 111-5 | - | - | - | YB14L-A2 | 12N14-3A |
| - | A115 | - | - | - | YB14L-A2 | 12N14-3A |
| - | A85 | - | - | - | YB14L-A2 | 12N14-3A |
| WHITE OUTDOOR | | | | | | |
| - | FST-16 | - | - | - | Y50-N18L-A | - |
| - | GT-1000 | - | - | - | Y50-N18L-A | - |
| - | GT-185 | - | - | - | Y50-N18L-A | - |
| - | GT-205 | - | - | - | Y50-N18L-A | - |
| - | GT-2550 H | - | - | - | Y50-N18L-A | - |
| - | LT-125 | - | - | - | Y50-N18L-A | - |
| - | LT-135 | - | - | - | Y50-N18L-A | - |
| - | LT-155 | - | - | - | Y50-N18L-A | - |
| - | LT-160 | - | - | - | Y50-N18L-A | - |
| - | LT-165 | - | - | - | Y50-N18L-A | - |
| YARD MAN | | | | | | |
| - | 13420 | - | - | - | - | 12N9-3A |
| - | 3420 | - | - | - | - | 12N9-3A |
| - | 3730 | - | - | - | - | 12N9-3A |
| - | Beelle & Yard Bug | - | - | - | YB14L-A2 | 12N14-3A |
| YARD PRO | | | | | | |
| - | 3730 | - | - | - | - | 12N9-3A |

Yuasa Battery Features

**Safety Valve
Flame/Arrestor**
relieves excess pressure.

**Thru-Partition
Construction**
provides shorter current path with less resistance than "over the partition" construction - you get more cranking power when you need it!

**Special Active
Material**
is compounded to withstand vibration, prolong battery life and dependability.

**Special Grid
Design**
withstands severe vibration, assures maximum conductivity.

**Special
Separator**
makes the battery spill-proof. Valve regulated design eliminates water loss and the need to refill with acid.

**Heat Sealed
Case to Cover**
protects against seepage and corrosion - bonded unit gives extra strength.

**Polypropylene Cover
and Container**
assures reserve electrolyte capacity for cooler operating temperatures; gives greater resistance to gas and oil - and impact in extreme weather conditions!



Introducing

Smart Chargers

The new range of Smart Battery Chargers from Yuasa, the world's leading battery manufacturer.

6 or 8-stage chargers and accessories to maintain premium battery performance for all motorcycle applications.



Battery Analysers

Yuasa's new range of motorcycle battery analysers ensure the most up-to-date and accurate test results.

A custom made solution that enables cost savings, improved customer service and increased revenues.

Test more batteries to sell more batteries.

To find out more about both Yuasa chargers and analysers contact your nearest Yuasa stockist.

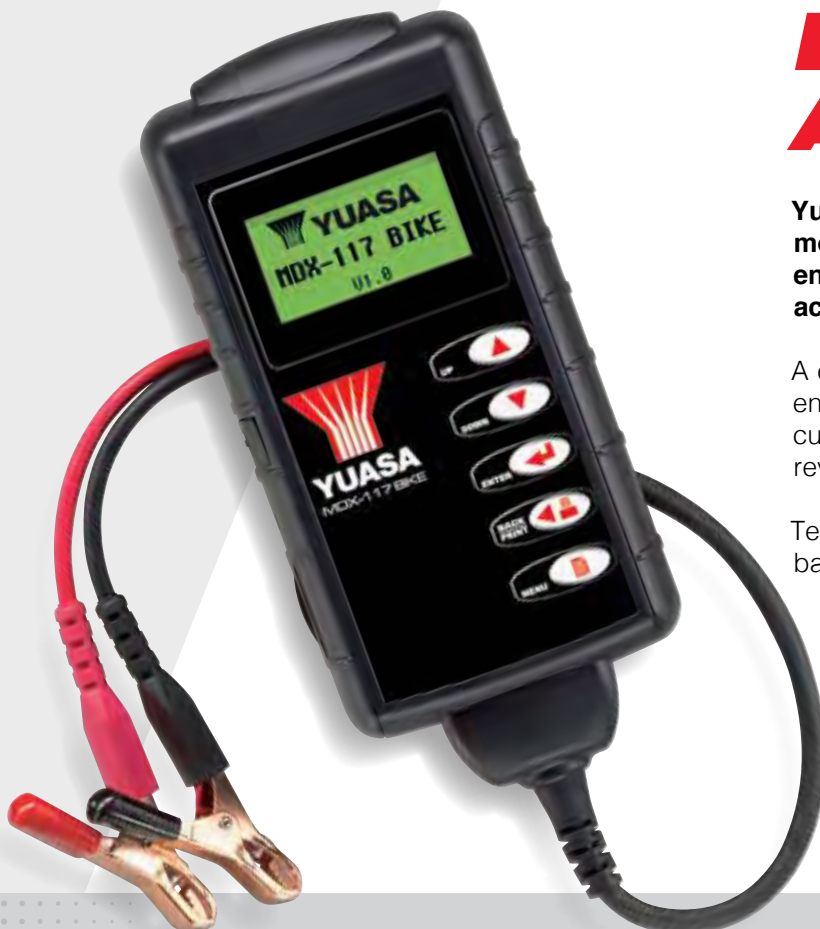



YUASA

www.yuasa.com



MOTORCYCLE



ATV



SNOWMOBILE



UTILITY



WATERCRAFT



GARDEN MACHINERY

Cat. No. | LIT059 2017

E. & O. E.